









Assembly Instructions

Caution: You must read these Assembly Instructions before you proceed

Care & Maintenance

-  • Do not put hot items directly on furniture surface.
-  • Do not clean furniture with harsh cleansers or polish.
-  • To obtain the longest lifespan of your outdoor product minimizing exposure to direct sunlight is recommended.
-  • Children should not climb or jump on the furniture.
-  • Do not write on furniture without a padded barrier to protect the surface.
-  • To obtain the longest lifespan of your outdoor products, avoid extended and lengthy exposure to rain, snow, and direct sunshine. Whenever possible cover the product and /or place under patio or awnings.
-  • Not for commercial use. For residential use only.
-  • Stains may be removed with mild soap solution and damp cloth.
-  • Dust and pick-up spills using a clean, non-colored, lint- free cloth.

Please look into the **Seat Panel** for hardware packs.

Loveseat - Right Side

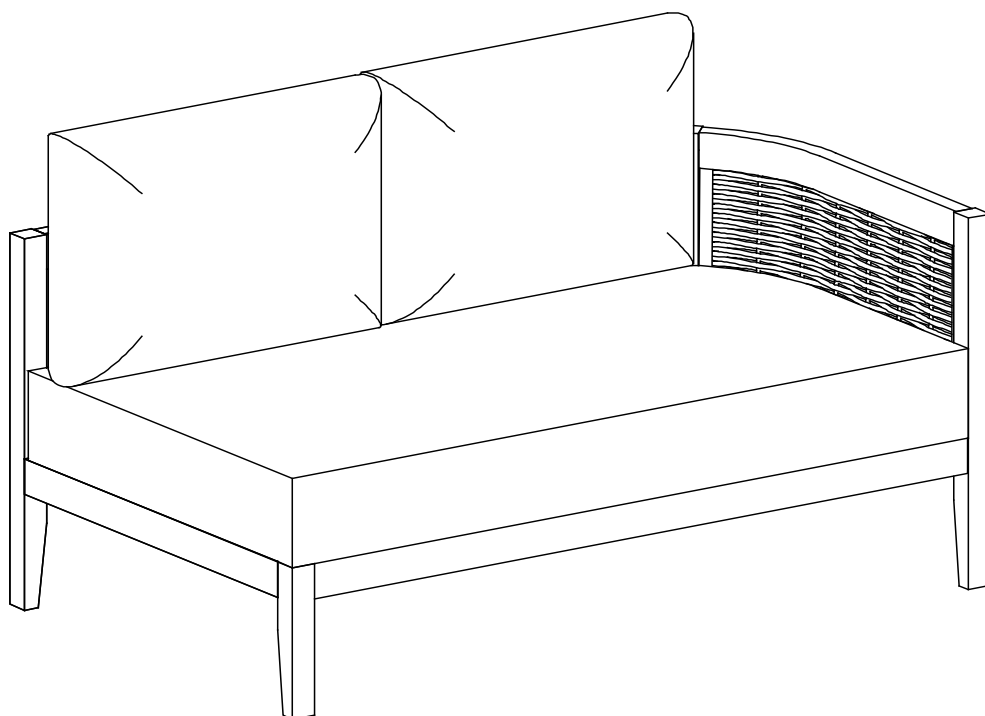

Caution: This Loveseat is NOT a TOY.



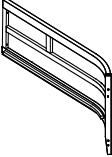
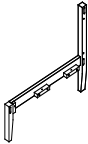
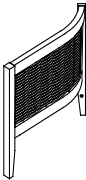
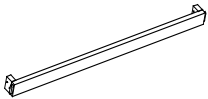
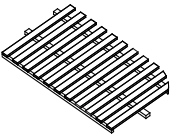
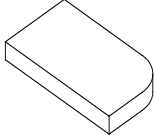
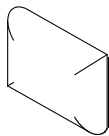

Keep your child / children at bay during the assembly process.

Whenever lifting or moving the Loveseat and to prevent any damage to it, two adults may be needed to execute these actions.

Part List

Label	Picture	Description	QTY
A		Backrest Panel	1
B		Left Leg Panel	1
C		Right Leg Panel	1
D		Support Bar	1
E		Seat Panel	1
F		Seat Cushion	1
G		Back Cushion	2

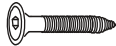
Hardware

Label	Picture	Description	QTY
①		Bolt (M6x35mm)	3
②		Bolt (M6x45mm)	5
③		Bolt (M6x60mm)	3
④		Screws (M6x35mm)	5
⑤		Allen Wrench	2

Assembly Preparation

Before Beginning Assembly:

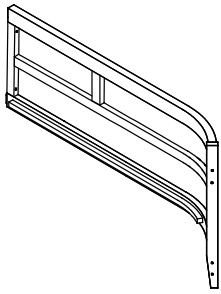

Ax1

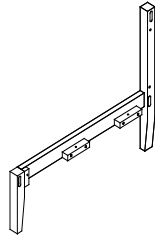

Bx1

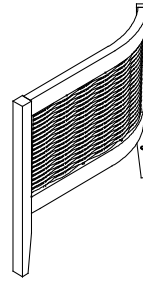

Cx1

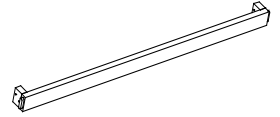

Dx1

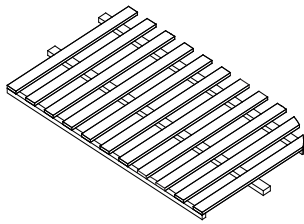



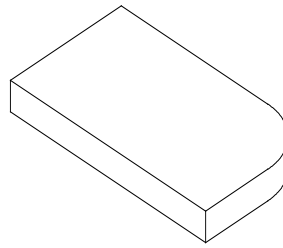

Ex1

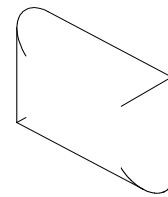

Fx1

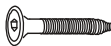

Gx2

- ①  x3
- ②  x5
- ③  x3
- ④  x5
- ⑤  x2



- Read instructions, cover to cover-



- Have 2 adults on hand for assembly-



- Do not assemble on flooring or carpet-



- Assemble on a clean non-marring surface (packing foam)-



- Save all packaging until finished-

Assembly Steps

Overview

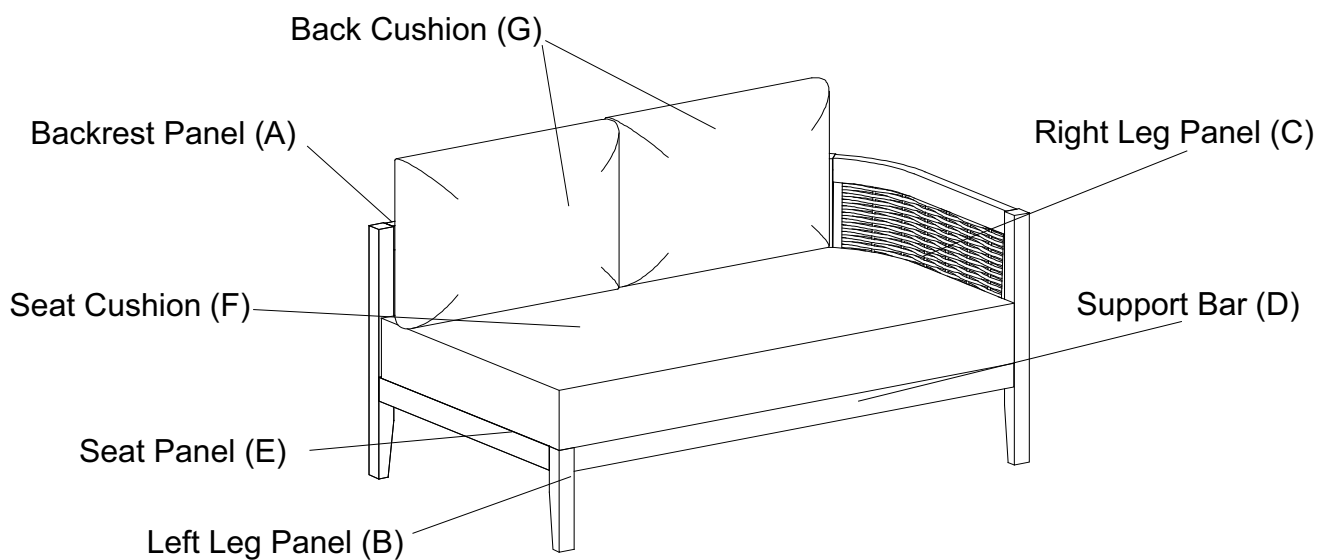

FRONT FACING

This Loveseat has multiple parts and may require up to some 30 minutes to assemble. To give you an overview of the Loveseat, the above picture is provided to help you put the various parts into perspective. Please read through the instructions here below to familiarise the parts and steps before assembly.

Step 1

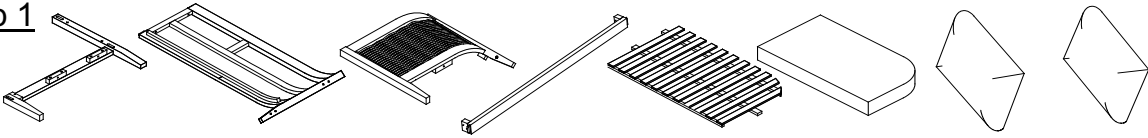

Unpack and place all parts on a clean, non-marring surface.

Step 2

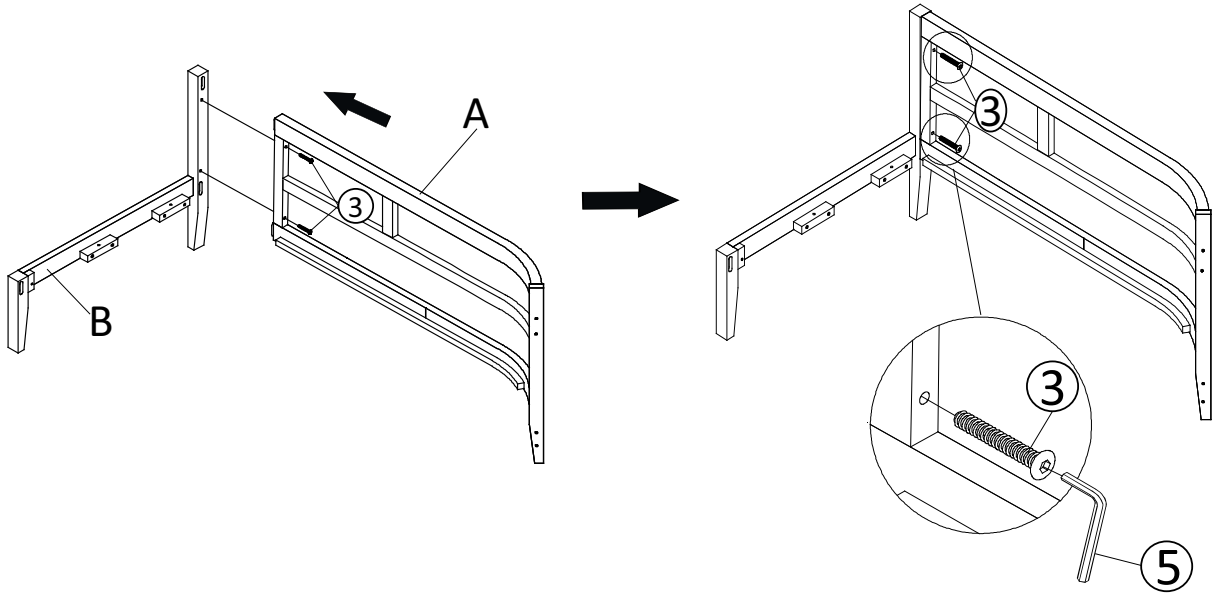

Place the Left Leg Panel (B) upright as shown in the picture above onto a clean, soft surface to avoid any scratches or damage to the product.

With assistance from your adult partner(s), attach the Backrest Panel (A) to the Left Leg Panel (B) using Bolts (3) and the Allen Wrench (5) as shown above.

Do not fully tighten the Bolts.

Step 3

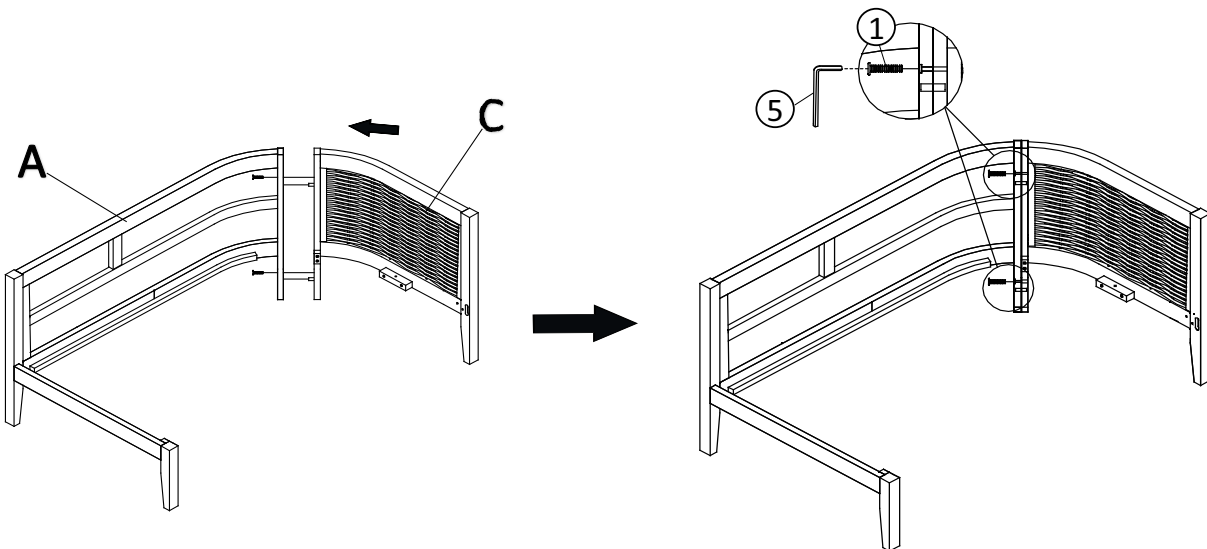

Place the Right Leg Panel (C) upright as shown in the picture above onto a clean, soft surface to avoid any scratches or damage to the product.

With assistance from your adult partner(s), attach the Right Leg Panel (C) to the assembled parts in Step 2:

Step 3: Use a Bolt (1) and the Allen Wrench (5) as shown above.

Do not fully tighten the Bolts.

Step 4

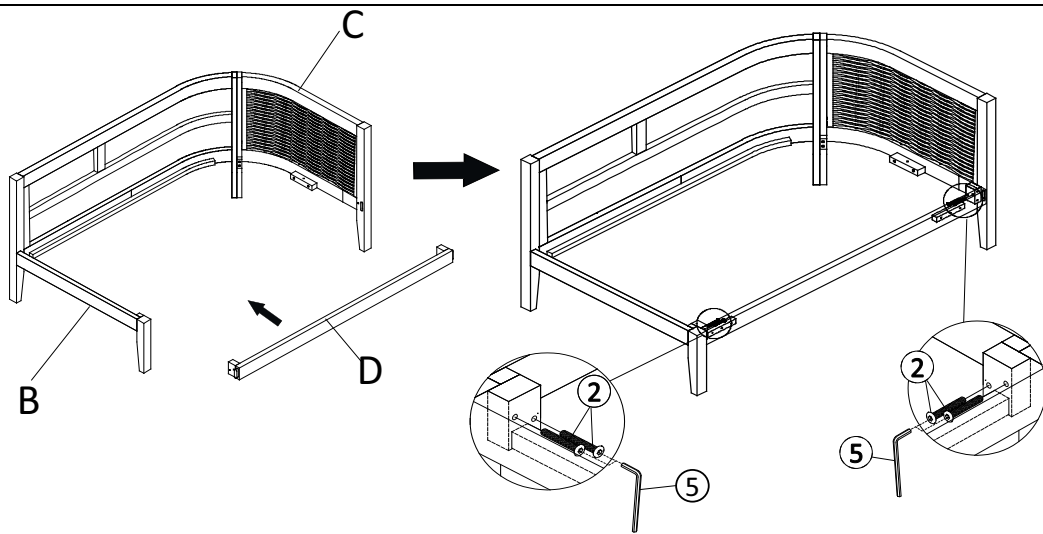

With assistance from your adult partner(s), attach the Support Bar (D) to the assembled frame in Step 3 using Bolts (2) and the Allen Wrench (5) as shown above.

Do not fully tighten the Bolts.

Step 5

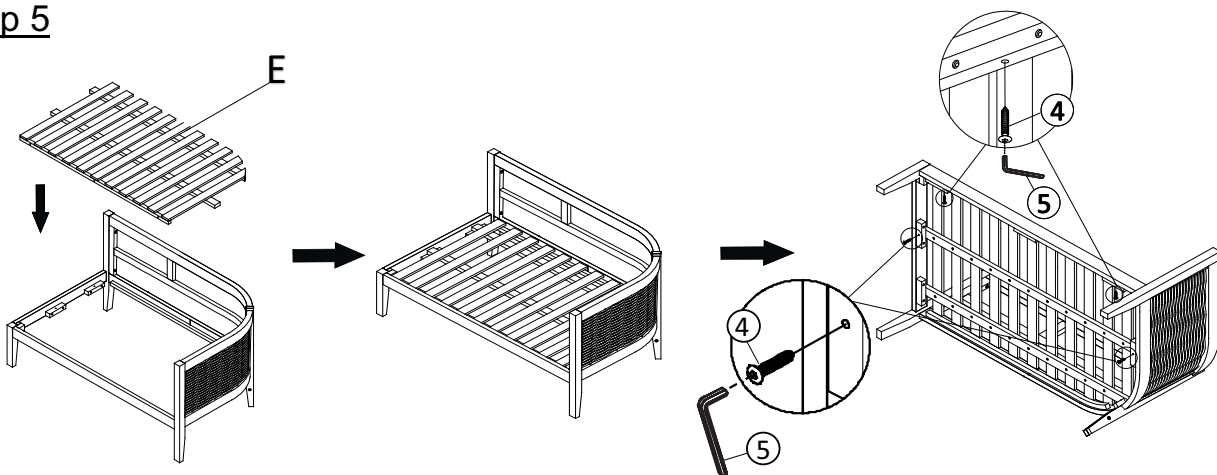

With assistance from your adult partner(s), attach the Seat Panel (E) onto the assembled parts in step 4 using Screws (4) and the Allen Wrench (5) as shown in the above picture.

Do not fully tighten the Screws.

Step 6

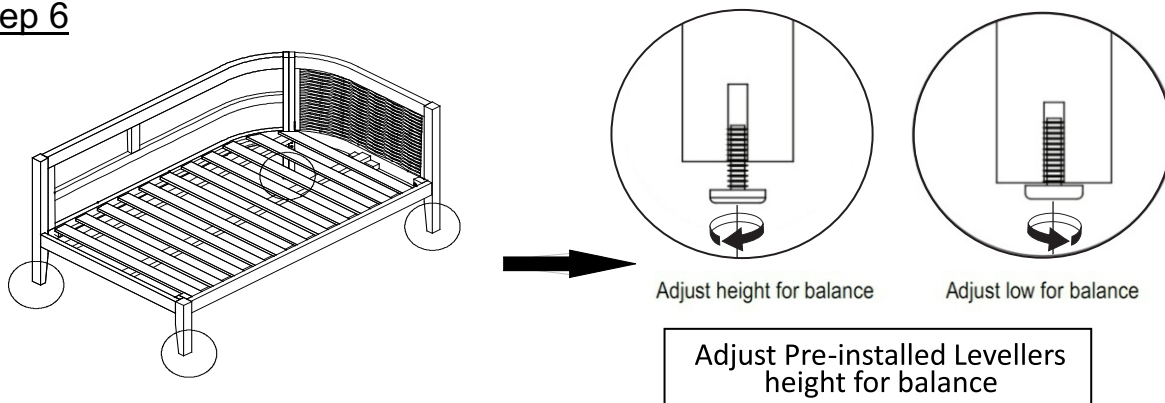

Inspect the Loveseat and make sure all parts are adequately connected.

Then EXERT pressure, floorwards onto the Loveseat with both hand

This pressure will help align all parts at all joints.

In a sequential manner, tighten all Bolts and Screws at all joints.

Adjust the Levellers until the Loveseat is level with the ground.

To adjust the Levellers, get assistance from an adult partner to lift/lean and hold the Loveseat while you are working.

CAUTION : When tightening these screws and bolts, tighten sequentially.

DO NOT tighten any screw or bolt fully and then move towards the next one. This could cause the frame to warp.

WARNING!! IF THE Loveseat IS NOT STABLE , IT COULD LEAD TO DAMAGING THE PRODUCT.

Step 7

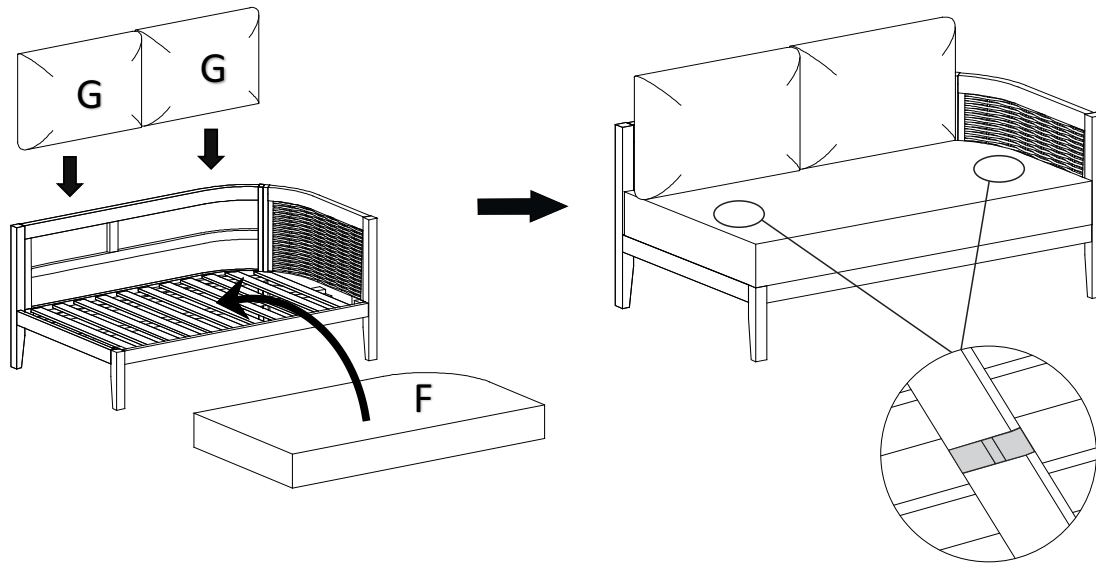

Place the Seat Cushion (F), then the Back Cushions (G) onto the Loveseat.
Then affix the "magic tape straps" around the Loveseat as shown above.
Your Loveseat is ready to be used.
This Loveseat can only be used on a flat, level surface.

Step 8

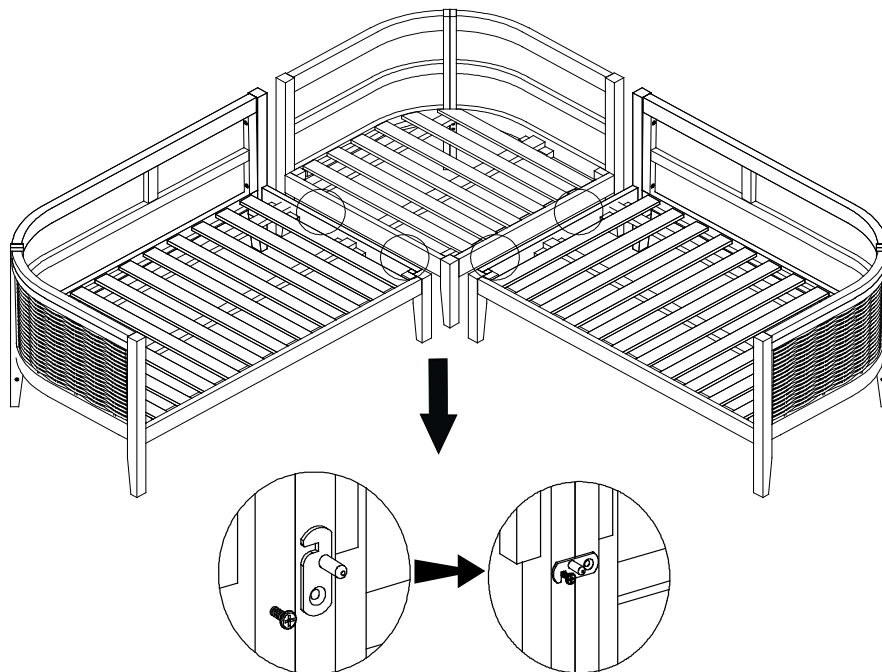

With assistance from your adult partners, place the Loveseats and Corner Seat facedown and connect the pre-attached clips to connect the Loveseats together.

Note: This is an optional step in case you want to connect the Loveseats and Corner Seat in the set together and should be performed before affixing the cushions.