

ASSEMBLY INSTRUCTIONS



CAUTION

◆ Inspect the wire insulation for any cuts, abrasions, or exposed copper that may have resulted during shipping. If there is a defect in the wire, do not attempt installation.

◆ Before starting installation of this fixture or removal of a previous fixture, disconnect the power by turning off the circuit breaker or by removing the fuse at the fuse box.

TOOLS REQUIRED



Ladder



Safety glasses



Electrical tape



Phillips screwdriver



Flat blade screwdriver



Pliers

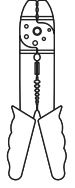

Wire strippers

* PARTS SHOWN MAY DIFFER SLIGHTLY PER LIGHT FIXTURE

HARDWARE INCLUDED



Cover

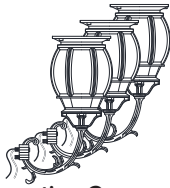

Decorative Component
(Hex Nut A, Washer A)



Cover

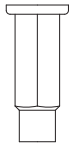

Centre Pillar

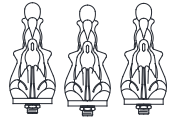

Finial
(Hex Nut B, Washer B)



Ball Nuts



screws (short)



Rubber Rings

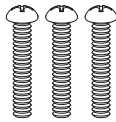

screws (Thick)

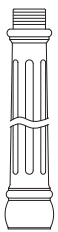

Decorative Pillar
(TOP)

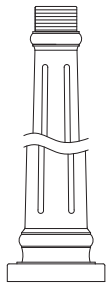

Decorative Pillar
(MIDDLE)

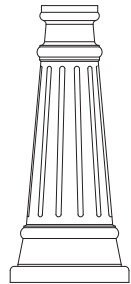

Decorative Pillar
(BOTTOM)

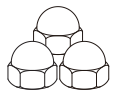

Big Cap Nuts



Electric Wire



Wire Nuts

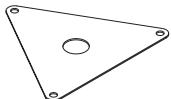

A Tripod

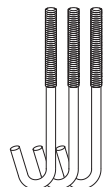

Iron Hook



Hex Nuts C

EXPLODED PARTS

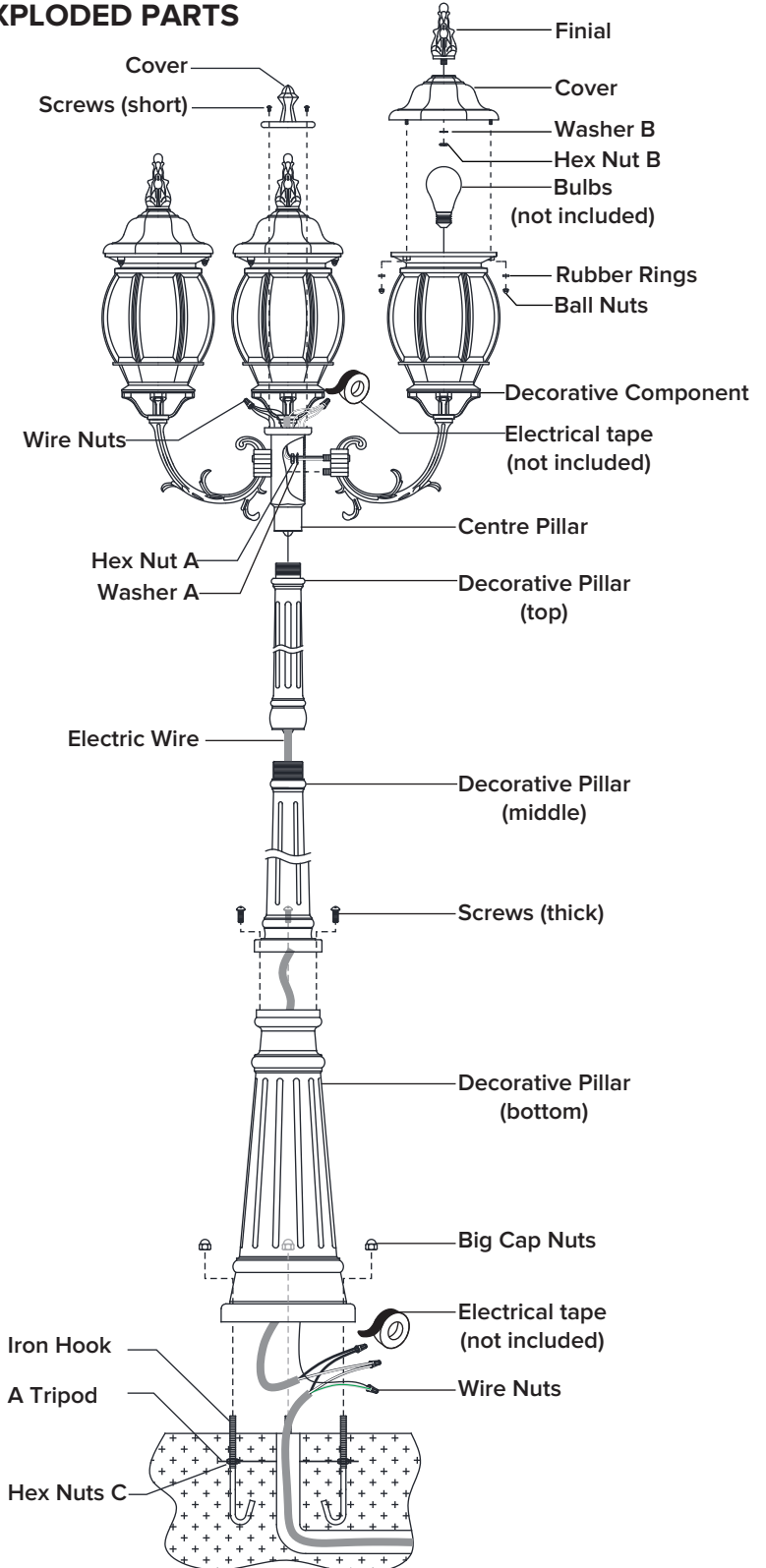

INSTALLATION

STEP 1

Insert **iron hook** into the **a tripod** with the **hex nuts C** then embed the component in the ground level with concrete.

Note: the threaded nipple must protrude outward 1 5/8"(41 mm).

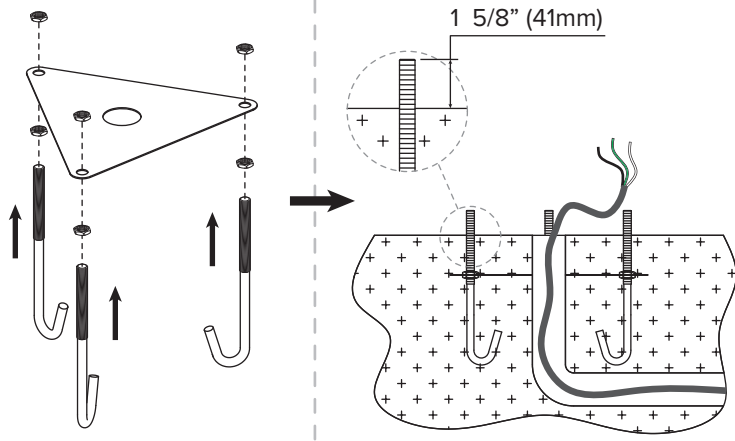

STEP 2

Successively install the **decorative component** into **centre pillar** and secure them with **washer A** and **hex nuts A**.

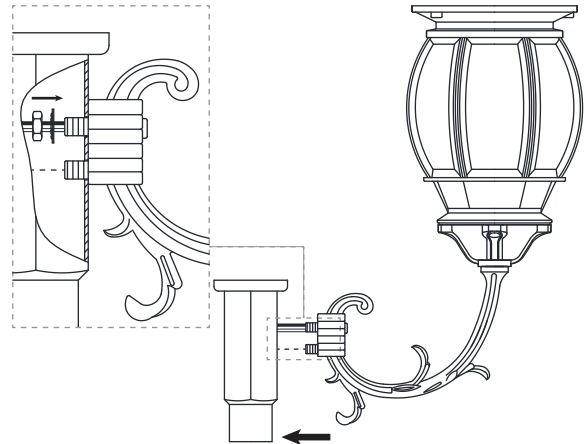

STEP 3

Run the **electric wire** across the **centre pillar**.

Next, connect the black wire and white wire with the supplied **wire nuts**. Secure with electrical tape(not included).

Then carefully tuck wires back into the **centre pillar**.

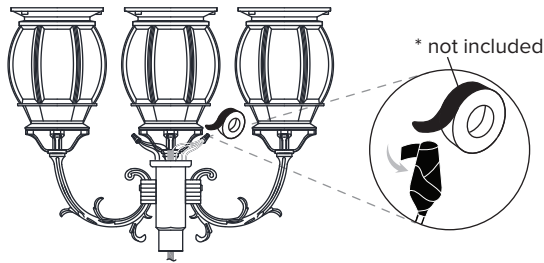

STEP 4

Install the **cover** into **centre pillar** and secure with **screws (short)**.

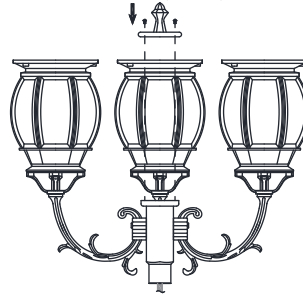

STEP 6

1. Remove the **hex nut B** and **washer B** from the **finial**.

2. Use the **hex nut B** and **washer B** to attach the **finial** to the **cover**.

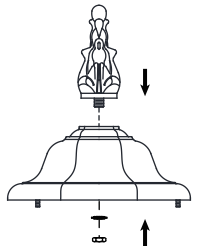

STEP 7

Place **cover** onto the **decorative component** and secure with **Ball Nuts** and **Rubber Rings**.

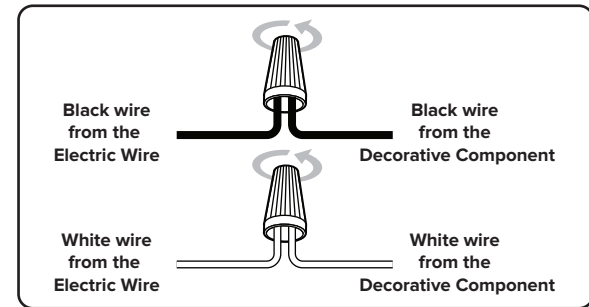
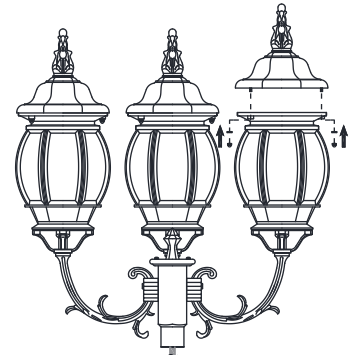

STEP 5

Install bulb (not included).

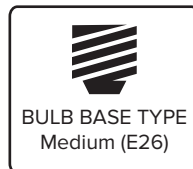

STEP 8

Pass through the **electric wire** into **decorative pillar(top)** and **decorative pillar(middle)**.

Secure the **decorative pillar(top)** into **centre pillar**, then secure the **decorative pillar(middle)** into **decorative pillar(bottom)**.

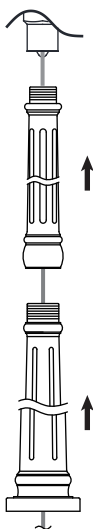

STEP 9

Pass through the **electric wire** into **decorative pillar(bottom)**, attach the **decorative pillar (bottom)** onto **decorative pillar (middle)** using **screws(thick)**.

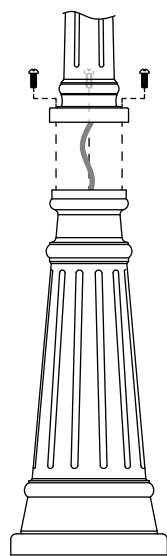

STEP 10

Connect the live wire, neutral wire and ground wire with the supplied **wire nuts**. Secure with electrical tape(not included).

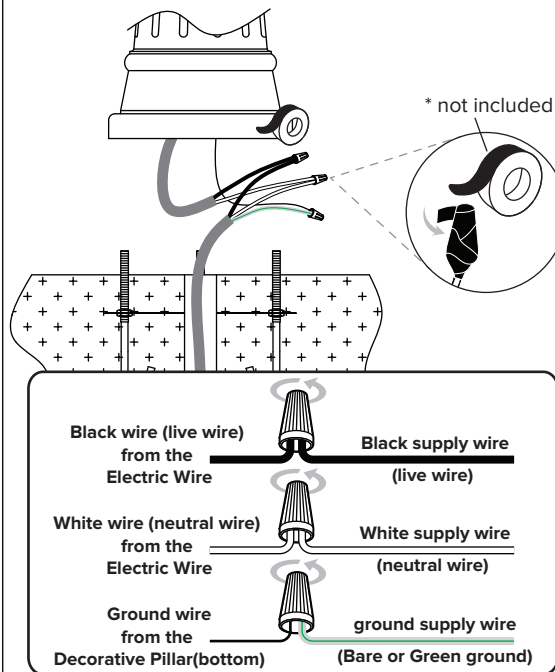

STEP 11

Attach the **decorative pillarto (bottom)** to the **iron hook** through screw holes, and secure it with **big cap nuts**.

