

**ATTENTION: DO NOT RETURN THIS PRODUCT!!!
PLEASE READ THE FOLLOWING!!!**

**NOTICE REGARDING HIGH GLOSS
PROTECTIVE FOIL AND PRODUCT CARE:**

After removing the protective foil from the gloss fronts, the acrylic surface of the boards is still soft and easy to scratch. With air contact, the hygroscopic acrylic layer hardens, and the board becomes more resistant to scratches. It takes approximately 48 hours for the acrylic layer of the board to fully harden.

Replacement parts are shipped out in one business day. You will receive a tracking number via email once your parts request has been processed.

**DO NOT CLEAN, WIPE, OR POLISH THE
ACRYLIC FRONTS FOR 48 HOURS AFTER
REMOVING THE PROTECTIVE FOIL!!!**



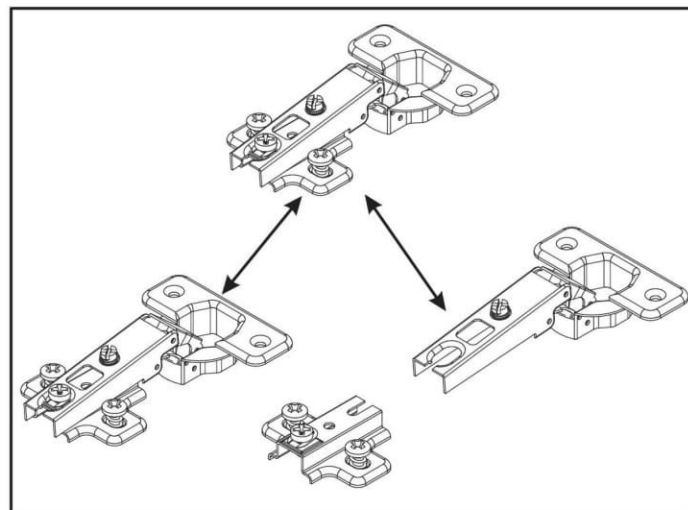
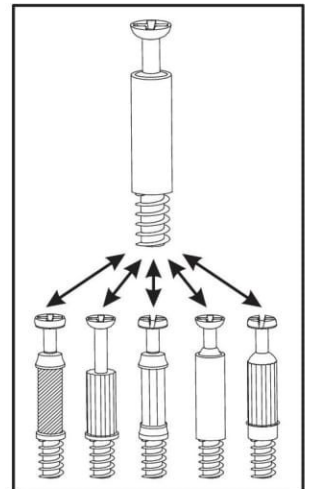
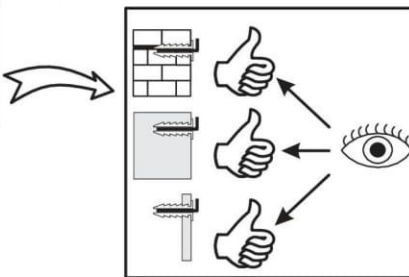
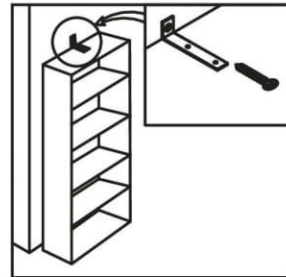
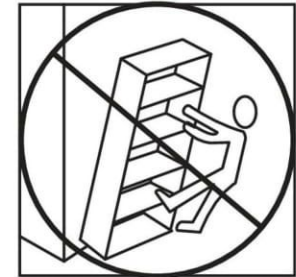
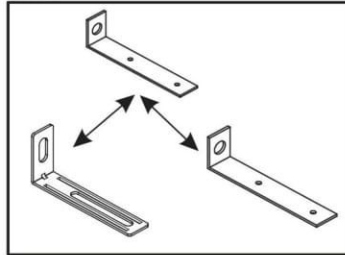
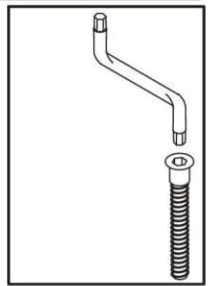
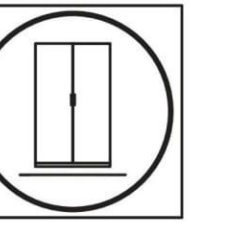
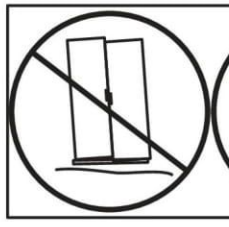
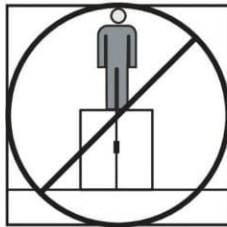
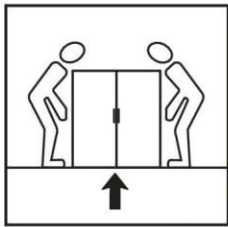
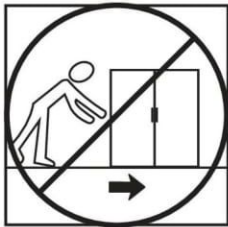
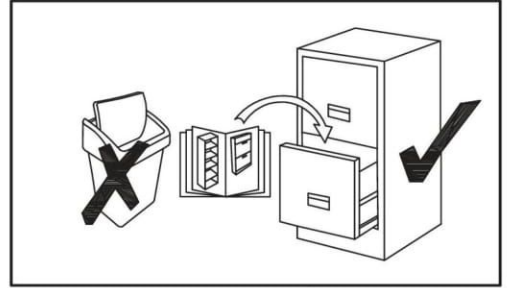
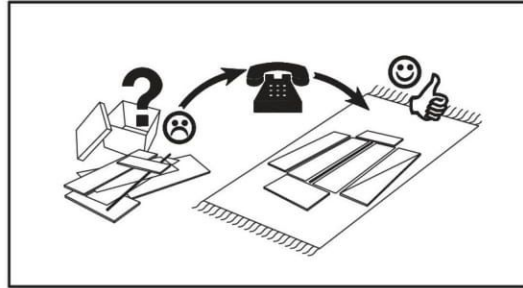
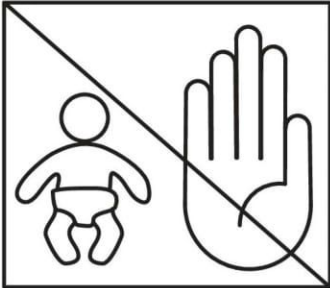
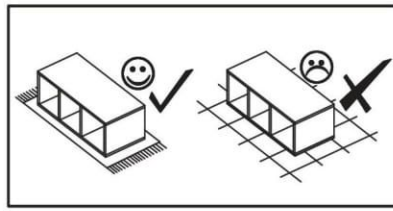
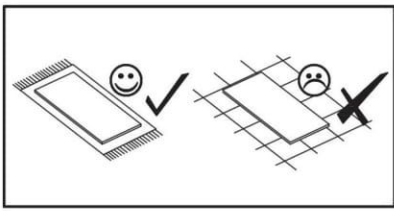

SIDEBOARD

 15 kg

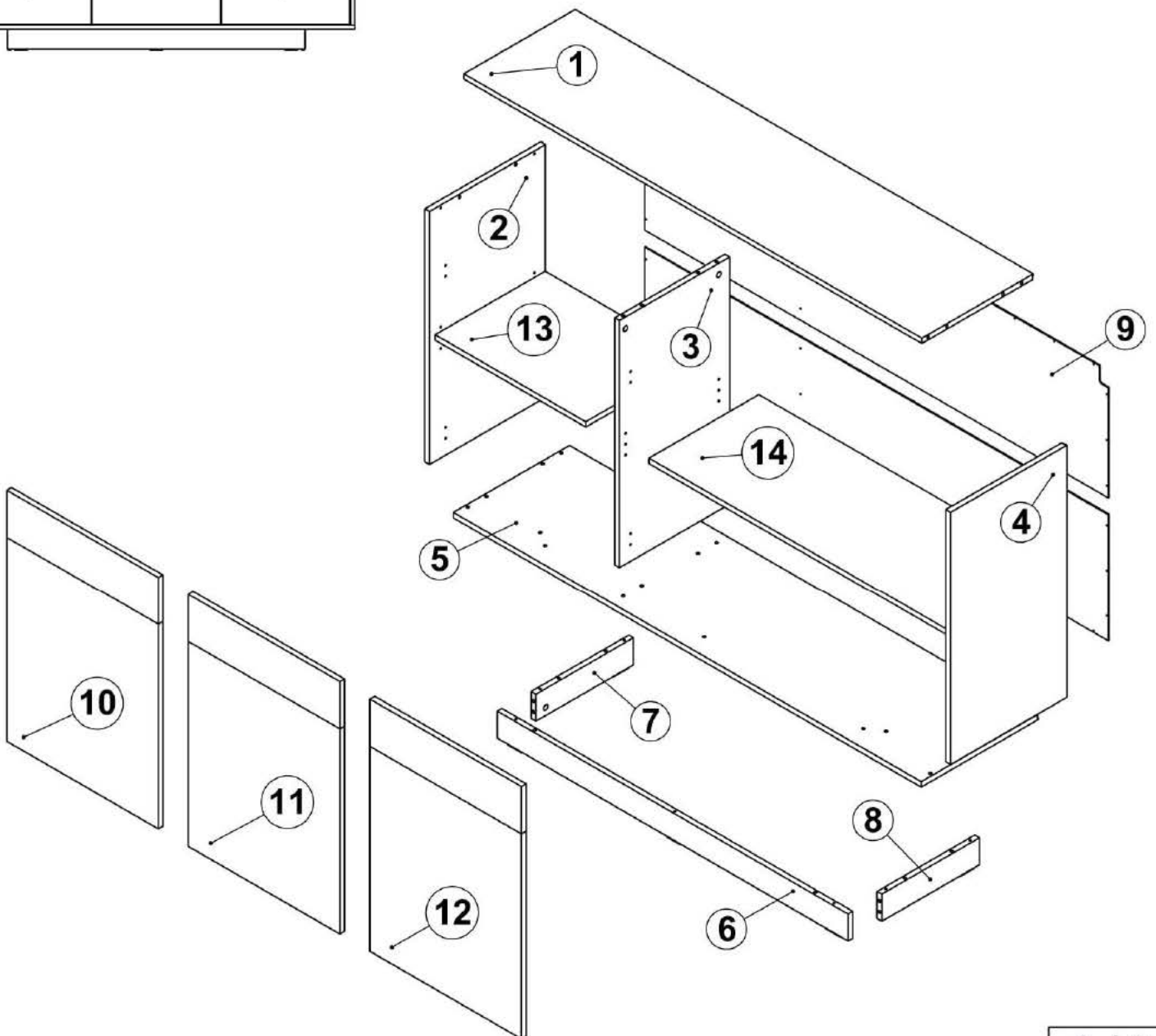
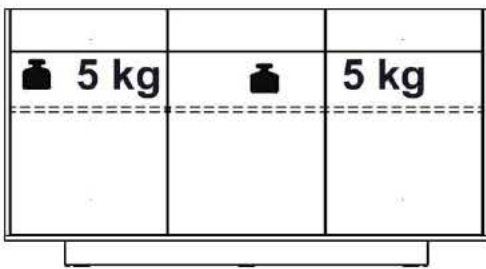

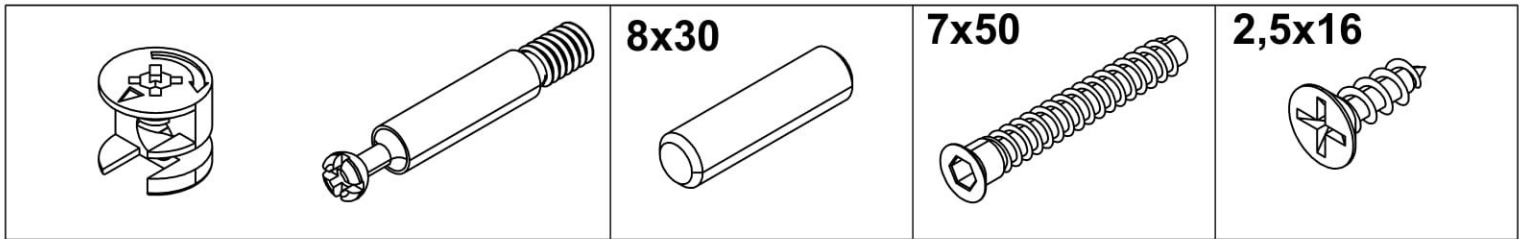

A x 8	B x 8	C x 20	D x 13	E x 42
--------------	--------------	---------------	---------------	---------------

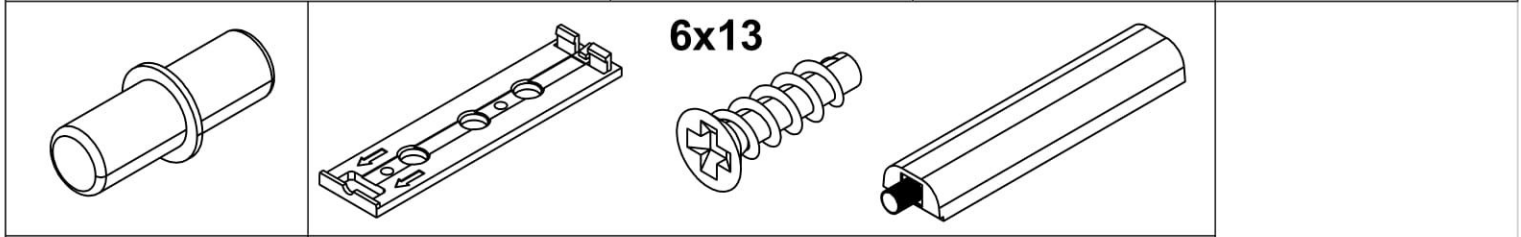

F x 8	H1 x 3	H2 x 6	H3 x 3
--------------	---------------	---------------	---------------

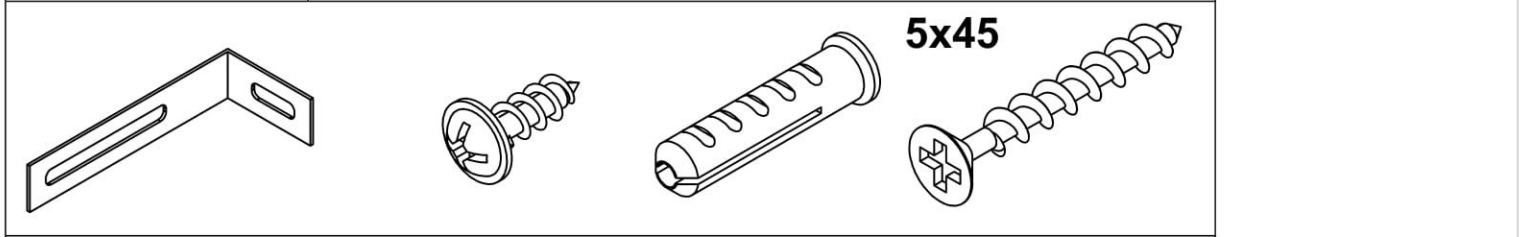

I1 x 2	I2 x 2	I3 x 2	I4 x 2
---------------	---------------	---------------	---------------

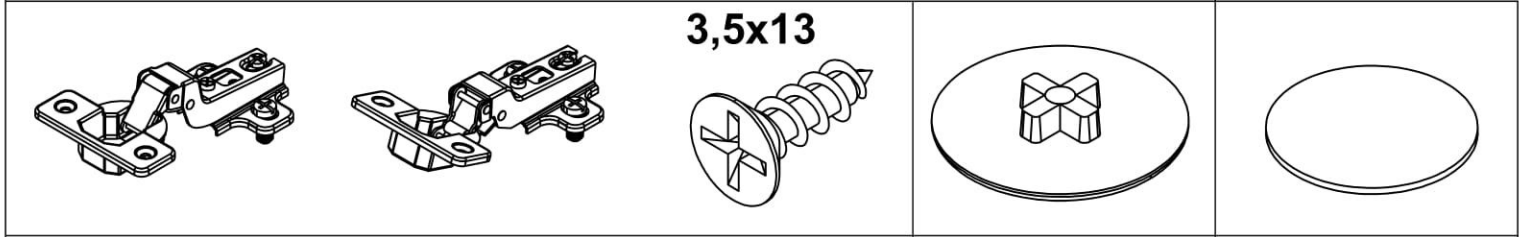

J x 4	K x 2	L x 12	M x 6	N x 7
--------------	--------------	---------------	--------------	--------------

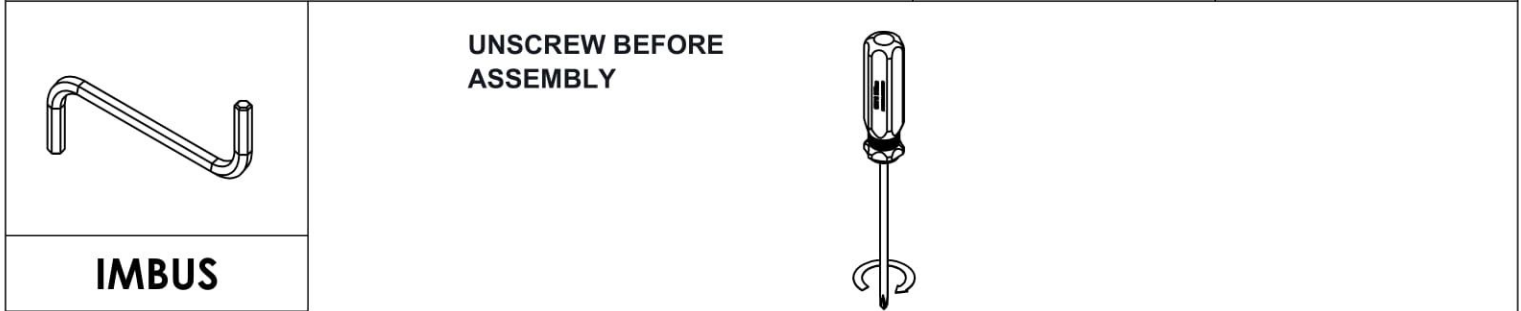





UNSCREW BEFORE ASSEMBLY

J2/K2

J1/K1

60 MIN.

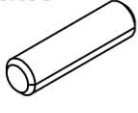
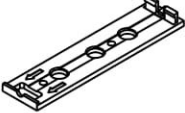
STEP - 1

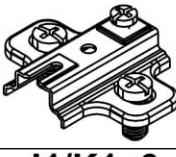
					
Ax8	Bx8	Cx20	H1x3	H2x6	J1/K1x6

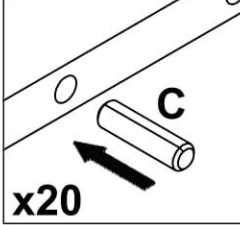
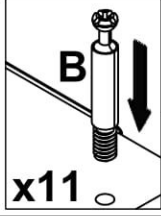
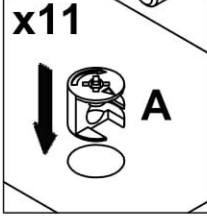
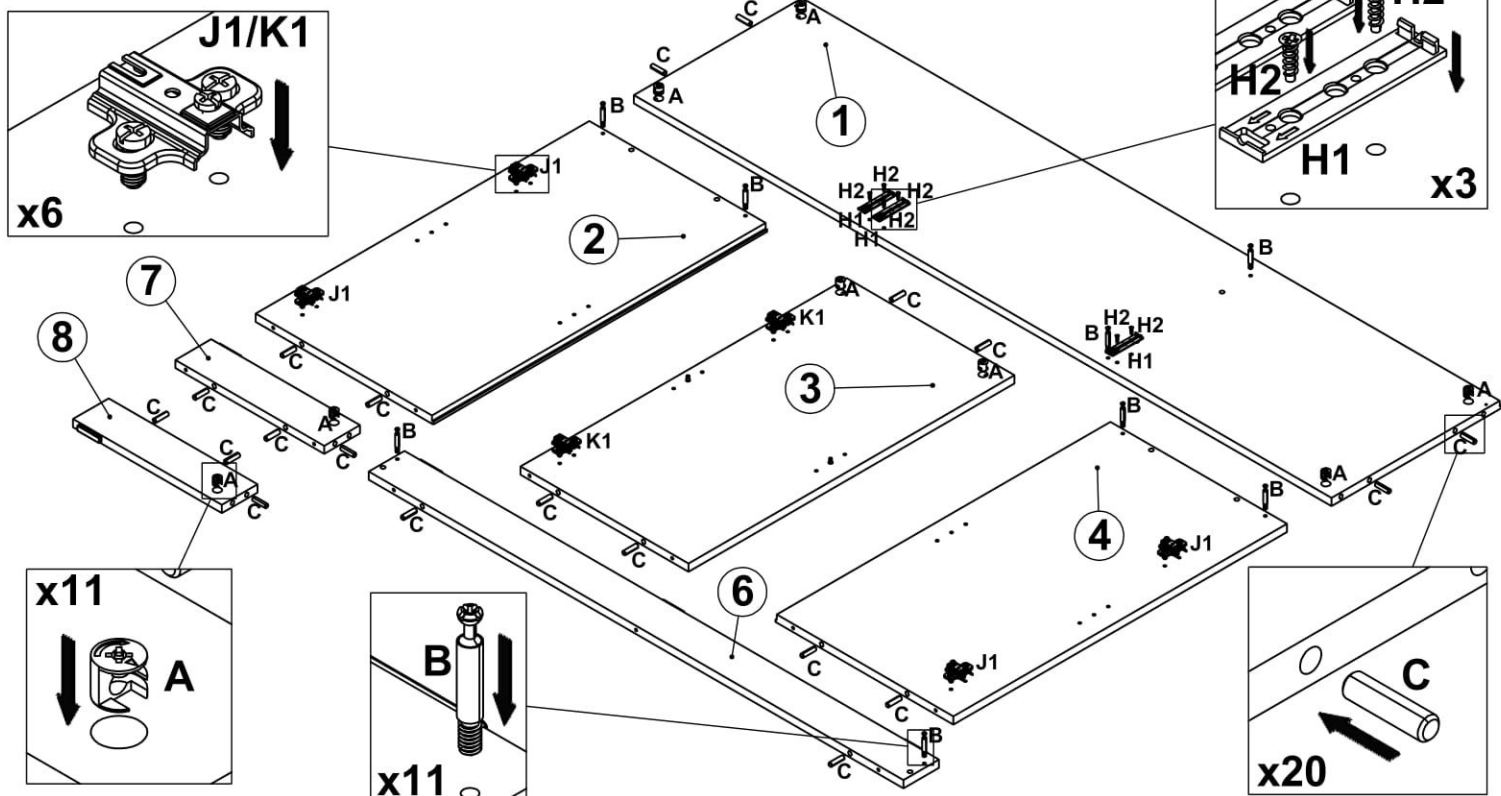
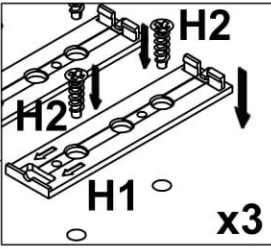
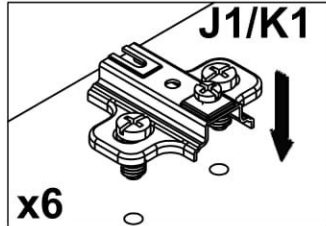
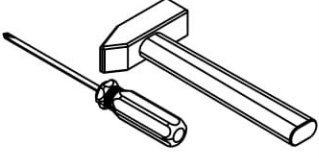

STEP - 2

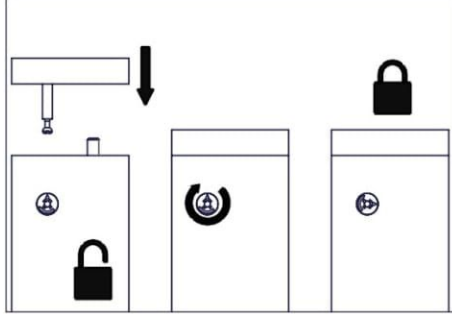
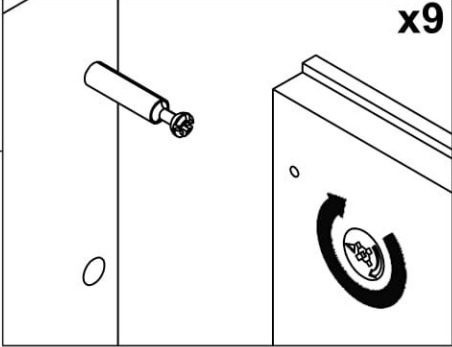
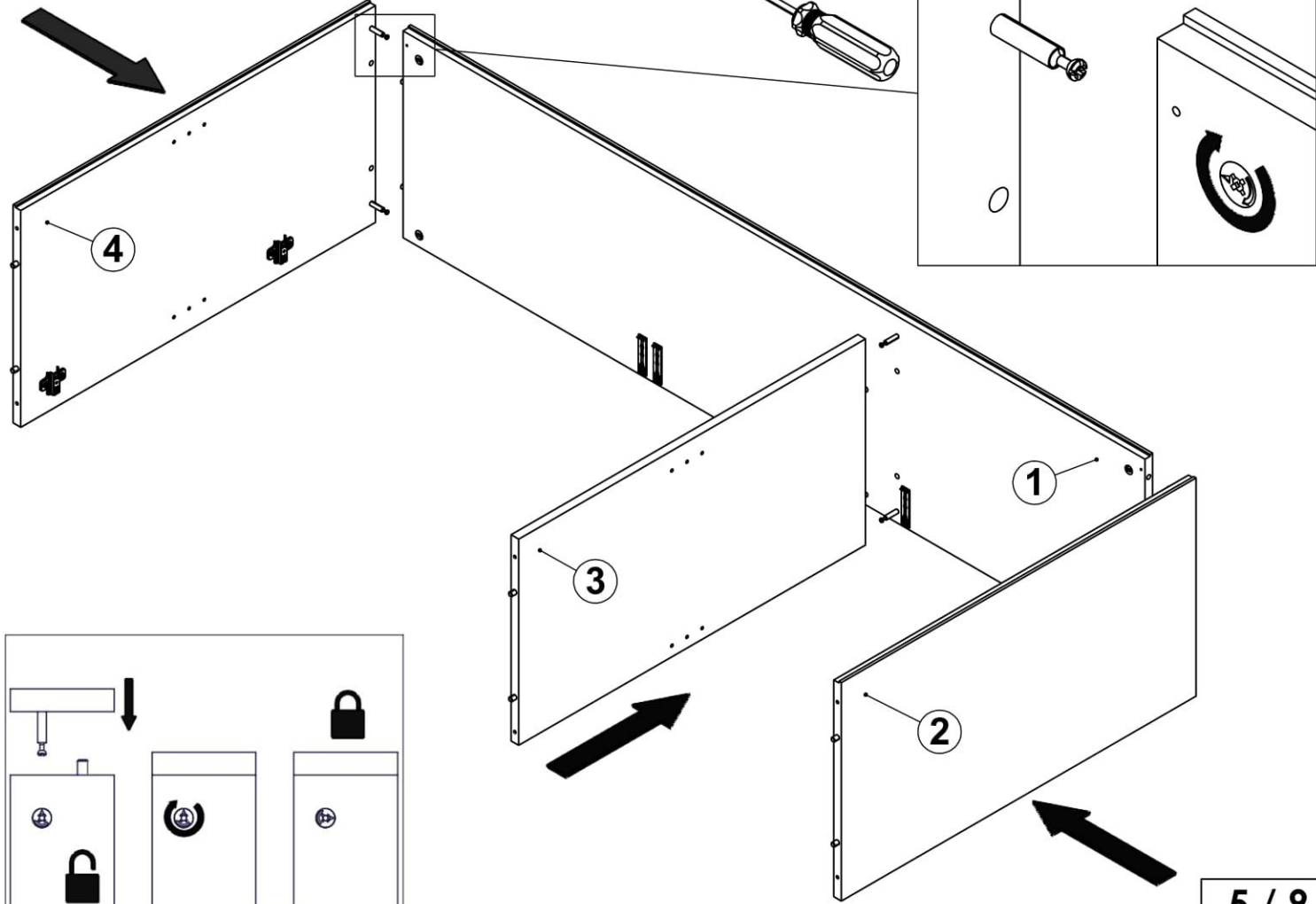

STEP - 3

7x50



Dx6

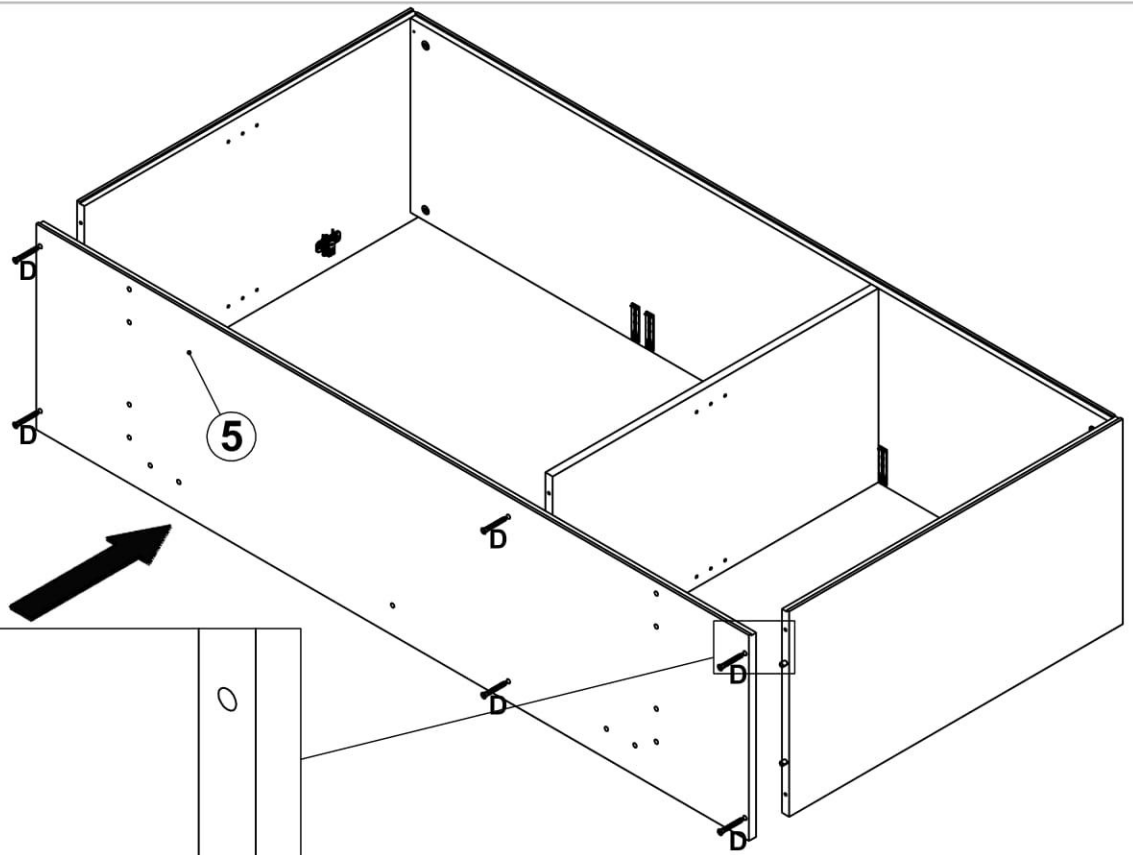

x9

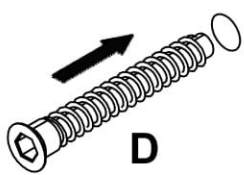

STEP - 4

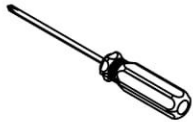

8

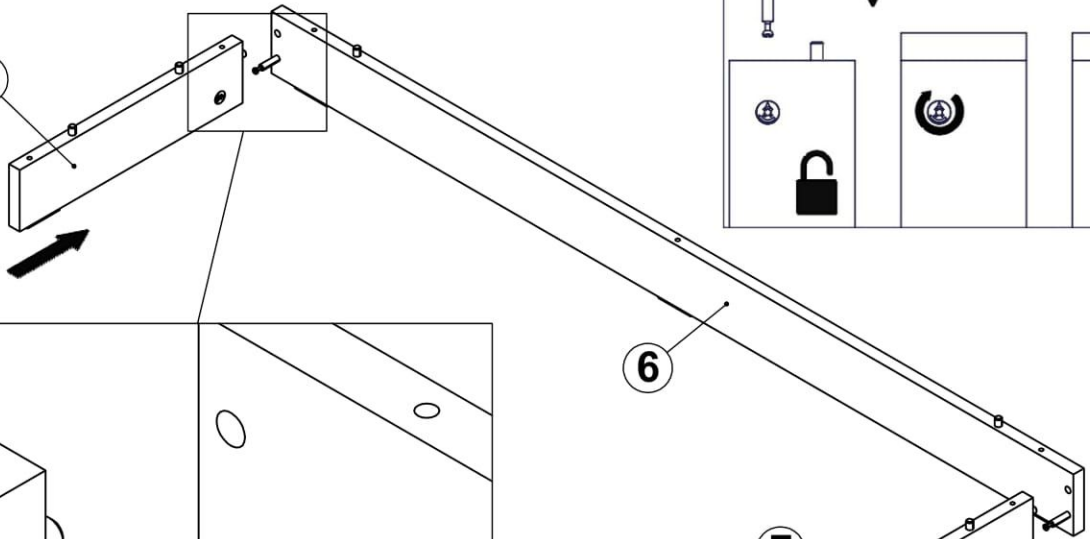

x2

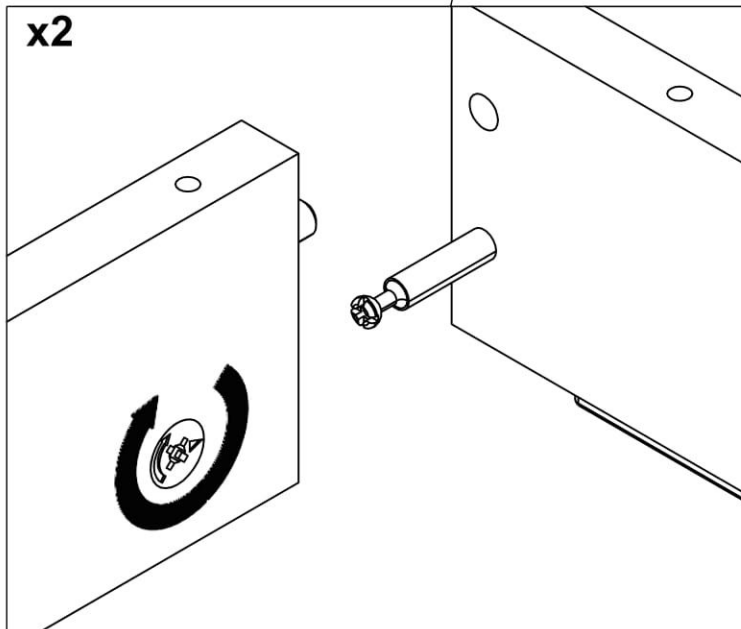

STEP - 7

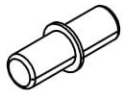

Fx8

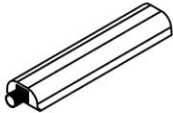

H3x3



I1x2



I2x2



Mx6

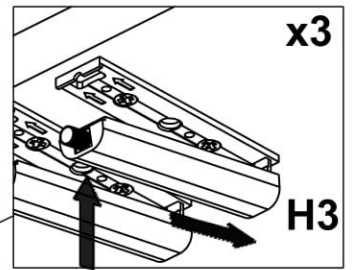

x3

H3

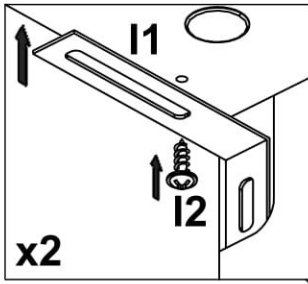

x2

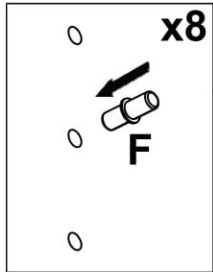
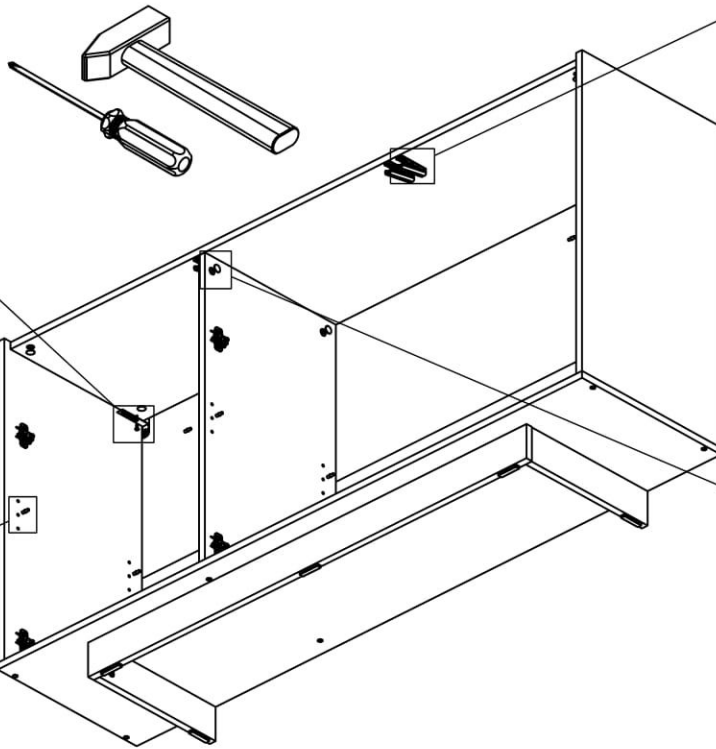

x8

F

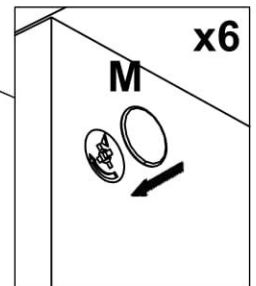

x6

M

STEP - 8



J2x4



K2x2

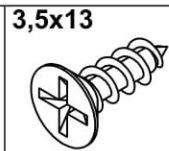

3,5x13

Lx12

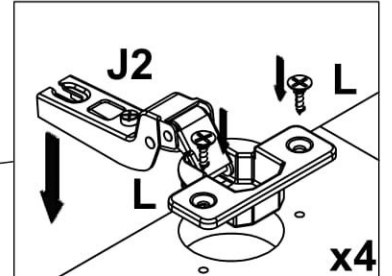

x4

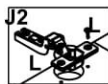
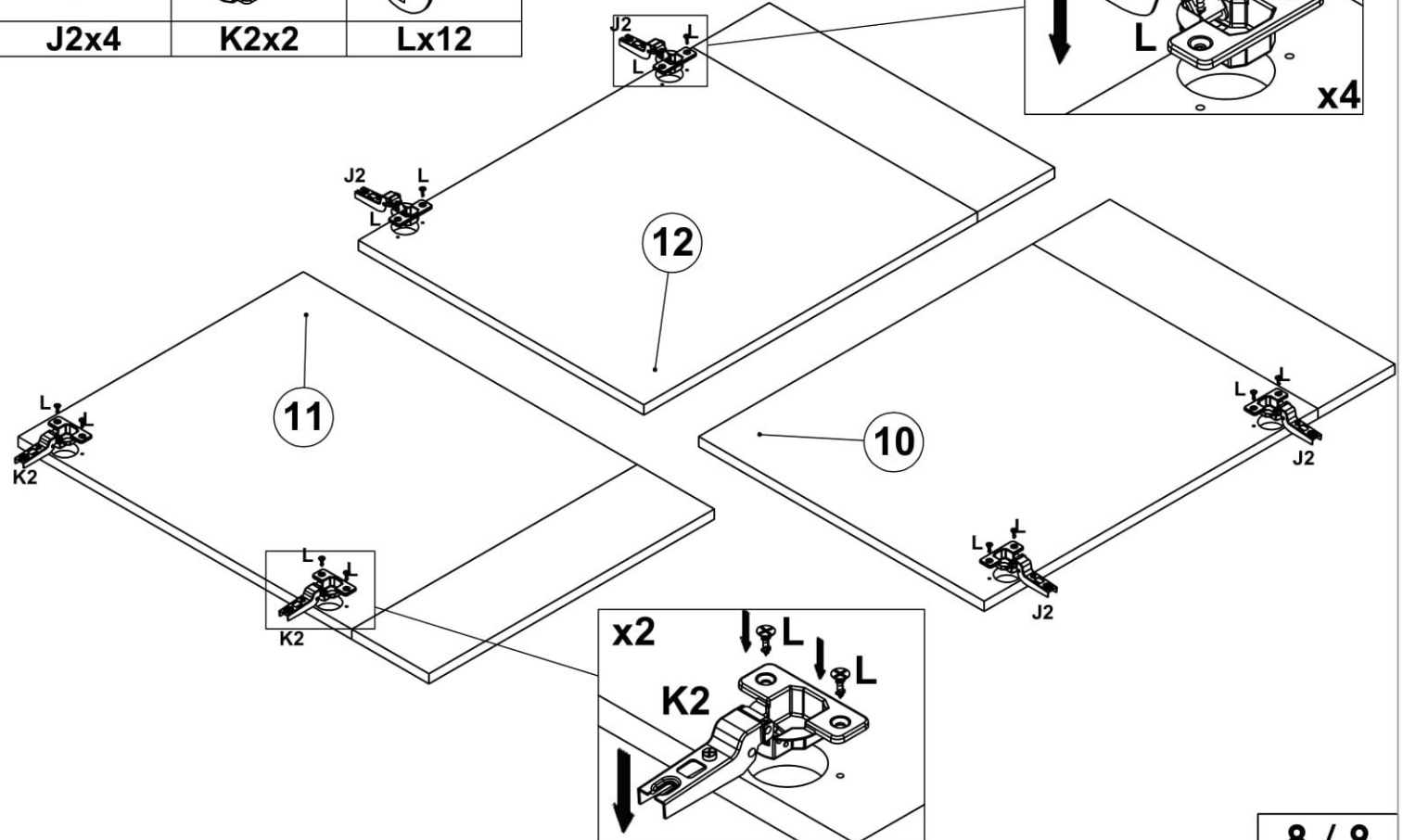

12

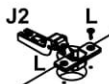

11

10

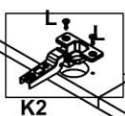

K2

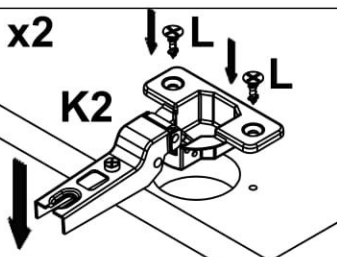

x2

K2

STEP - 9

!!! ATTENTION !!!



Nx7

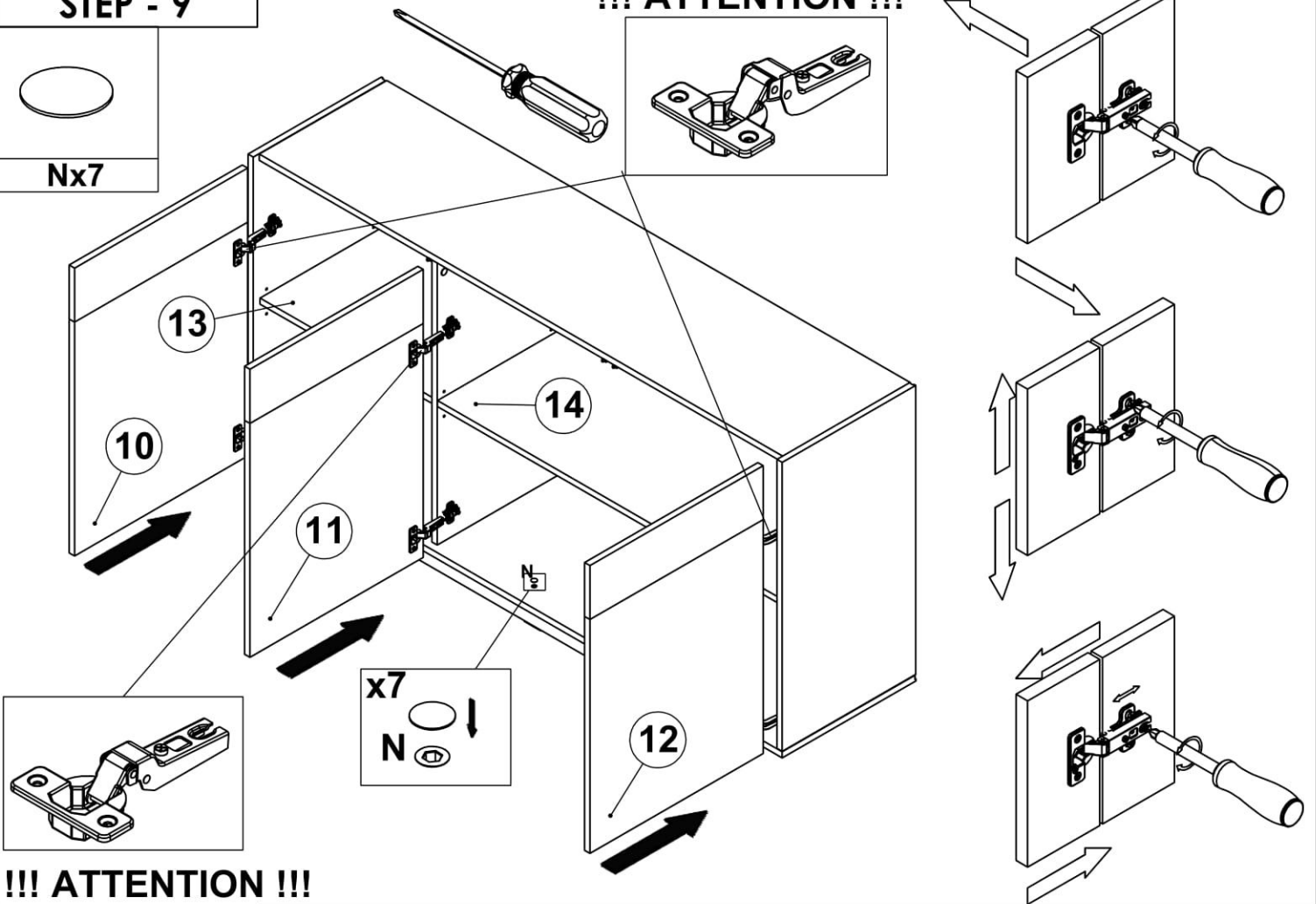

!!! ATTENTION !!!

STEP - 10



13x2

5x45



14x2

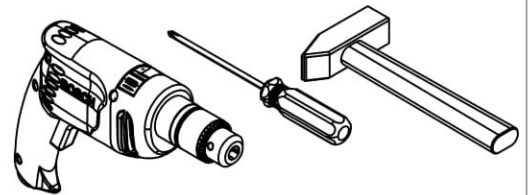

x2

