

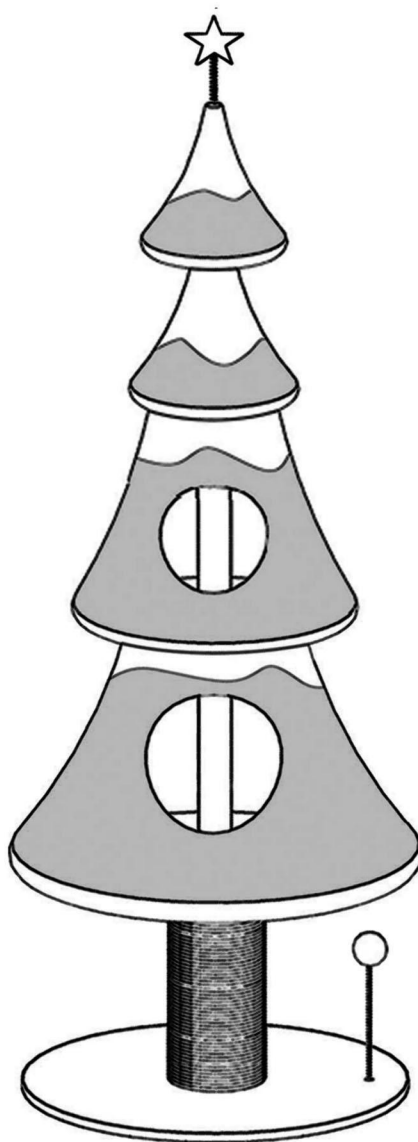

## The Christmas Tree Cat Climber

ITEM NO: ZCT007



### ORIGINAL INSTRUCTION MANUAL

Hi pet parent, if you'd like a digital version of the manual or an installation video, please visit [www.keygarzone.com](http://www.keygarzone.com) and search for the item number.

# Contact Information

Question about your product? We're here to help. Contact us by:



707-392-8405



support@keygarzone.com



www.keygarzone.com



Orders FAQ



Product Assembly



Product Inquiry



Chat Support



Returns & Refunds

If you have any issues, kindly reach out to us with your order number and some pictures if you can. That'll help us understand your concern faster and find the best solution for you. We will contact you within 24 hours and provide you with a satisfactory solution.











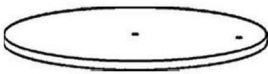

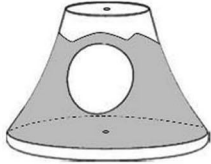
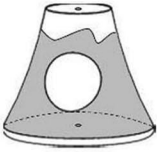

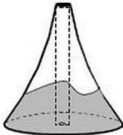

**! NOTICE** Please retain these instructions for future reference.

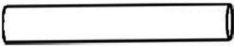
- Carefully unpack all the components and verify that all the necessary parts are included as listed in the packaging.
- Identify each component and refer to the provided assembly diagram or step-by-step instructions.
- Assemble the item in the order specified to ensure proper alignment and fit.
- Use the provided tools or recommended tools for assembly. Do not use excessive force when tightening screws or bolts.
- If any difficulties arise during assembly. Consult the troubleshooting section or contact our customer support.

★★★★★ Spread the cuteness ★★★★★

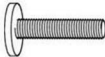
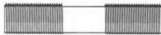
If you and your pet are loving this product, we'd be thrilled if you could share an adorable photo of your pet with it! Feel free to spread the cuteness.

# PARTS LIST

1  φ600mm 1×	2  350mm 1×	3  φ600mm 1×
4  φ400mm 1×	5  φ280mm 1×	6  1×
7  φ180mm 1×	8  1×	9  300mm 1×
10  250mm 1×	11  200mm 1×	12  1×
13  1×	A  M8*40mm 1×	B  M8*80mm 4×
C  M5 1×	D  1×	E  1×

# EXPLODED VIEW

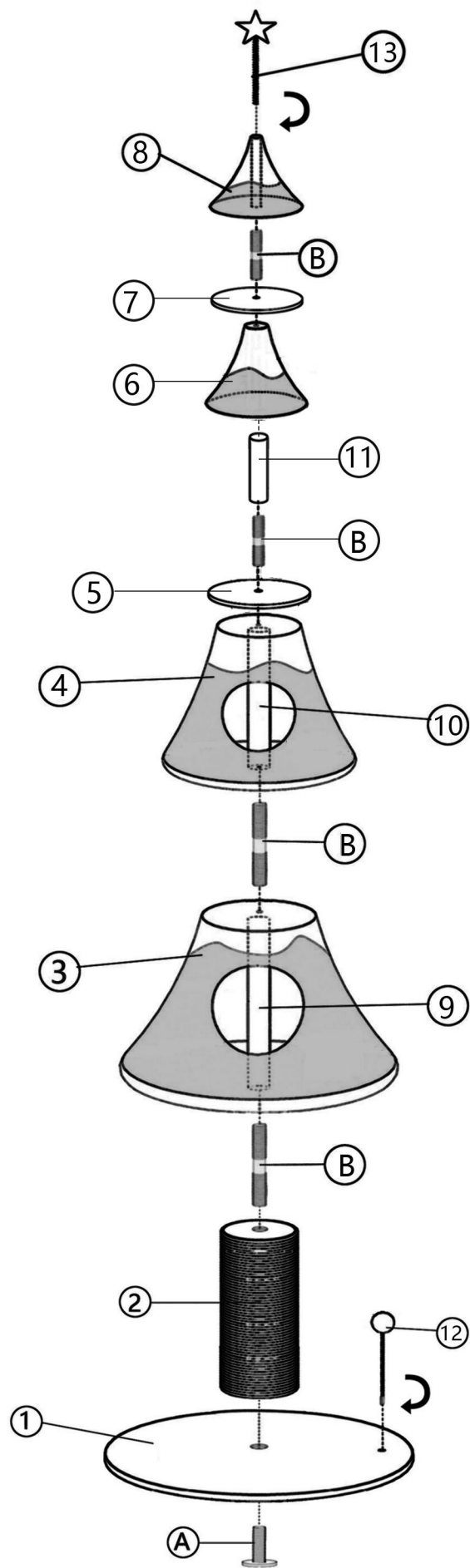

# ASSEMBLY

Before you start assembling, please check that all the listed parts are included. If anything is missing, pause assembly and kindly reach out to us at [support@keygarzone.com](mailto:support@keygarzone.com)—we're happy to help!

1

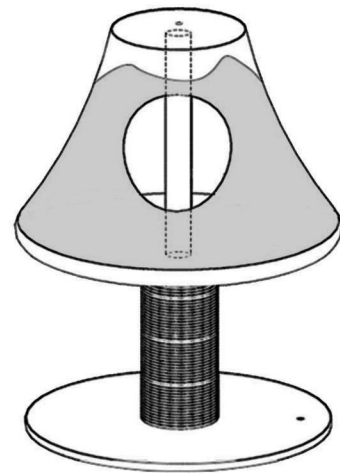
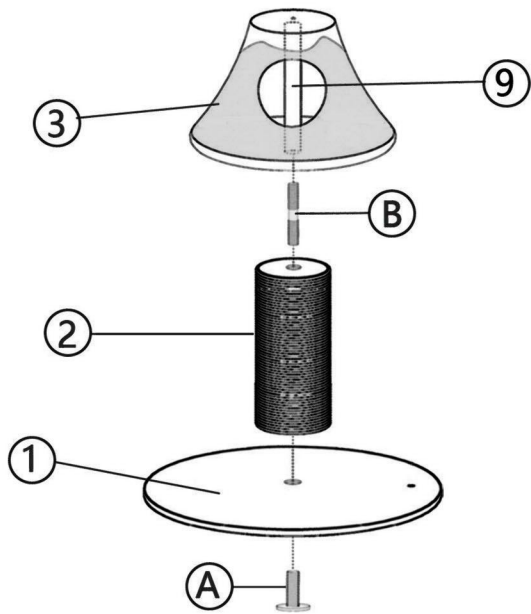

2

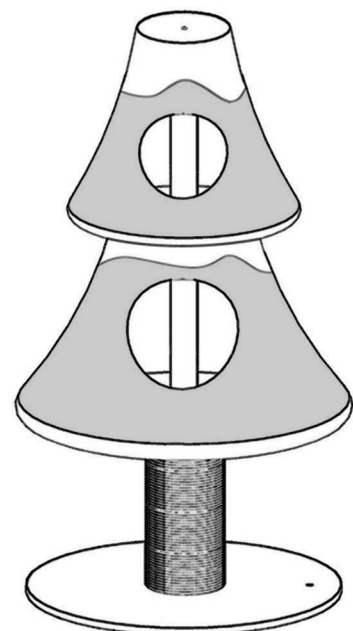
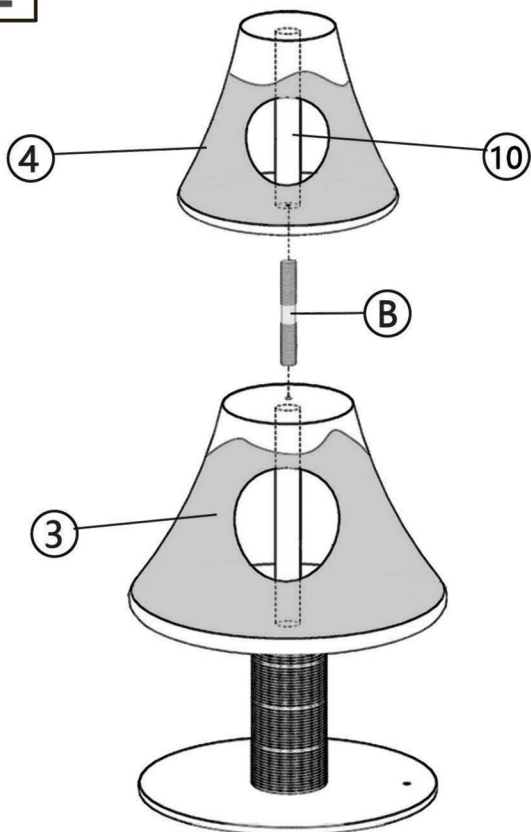

3

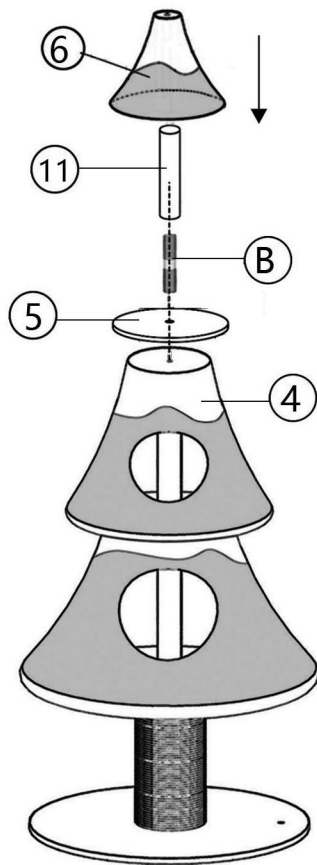

Please note that Parts 6 and 8 are fabric covers that need to be fitted over the frame.

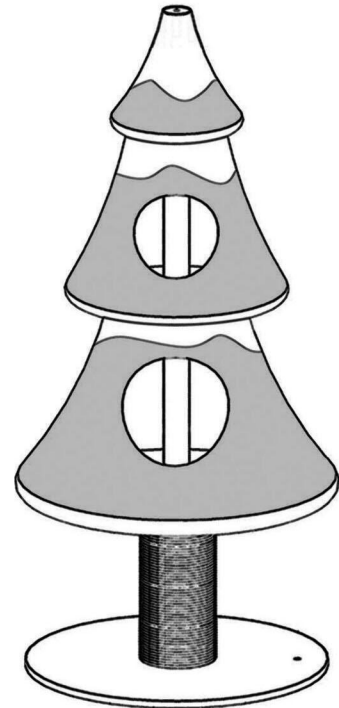

4

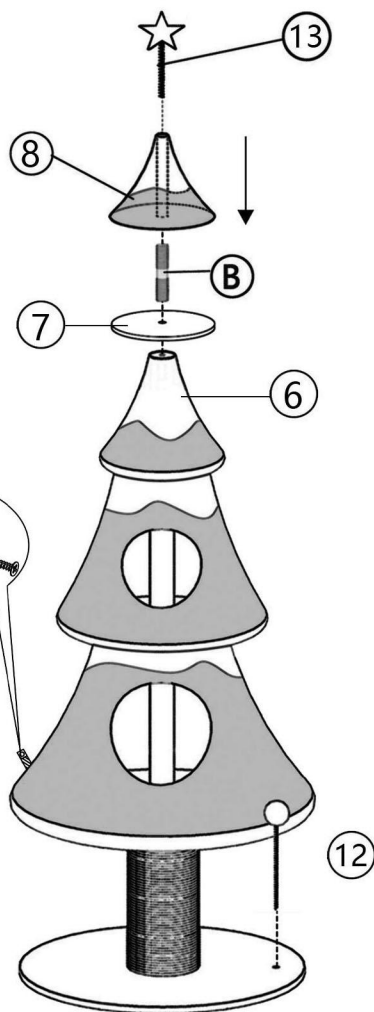

**NOTE:**  
The cat tree can be securely mounted to the wall with the safety strap at the back, ensuring safety by keeping kids away from potential hazards.

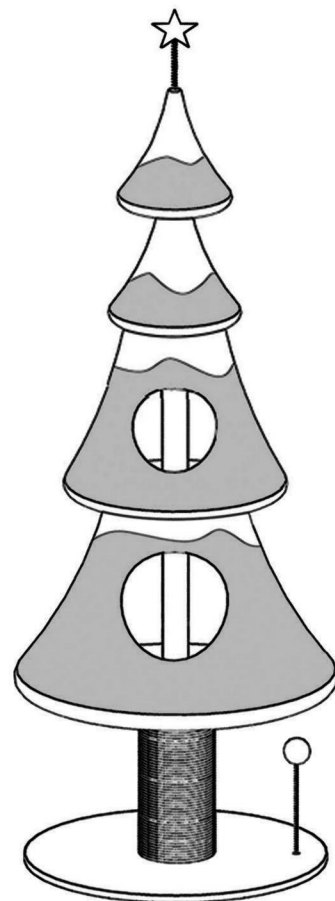



## Stay Connected!

Be the first to hear about new products, giveaways, pet tips, and more by signing up on our website or following our store.

**Visit [www.keygarzone.com](http://www.keygarzone.com) or scan the QR code to join us!**

