

615153(90X190/90X200CM)

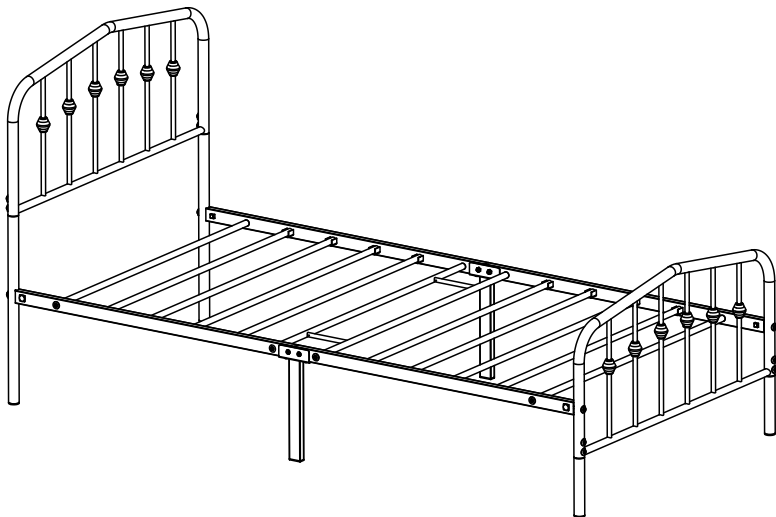

- EN** - Please read this instruction manual carefully before attempting to install.
DE - Bitte lesen Sie diese Bedienungsanleitung vor der Montage gründlich durch.
ES - Por favor lea con atención el manual de instrucciones antes de llevar a cabo el ensamble.
FR - Lisez attentivement cette notice avant de commencer le montage.
IT - Si prega di consultare il libretto delle istruzioni prima del montaggio.

IMPORTANT/WICHTIG/ATENCIÓN

IMPORTANT/IMPORTANTE



EN - We recommend **1** or more people to install.
DE - Wir empfehlen, dass die Montage von **1** oder mehreren Personen durchgeführt werden sollte.
ES - Recomendamos realizar el ensamble con **1** o más personas.
FR - Il est recommandé d'effectuer le montage à **1** personne(s) ou plus.
IT - È necessaria la presenza di **1** o più persone per il montaggio di questo prodotto.



EN - The expected assembly time is **1 h**.
DE - Die Montagezeit beträgt durchschnittlich **1 h**.
ES - El tiempo aproximado de ensamble es de **1 h**.
FR - Le temps nécessaire est estimé à **1 h**.
IT - Il tempo previsto per il corretto assemblaggio è di **1 h**.



EN - Not intended for use by children.
DE - Nicht geeignet für Kinder.
ES - Producto no apto para niños.
FR - Produit non destiné à être utilisé par des enfants.
IT - Questo prodotto non è destinato all'uso da parte dei bambini.









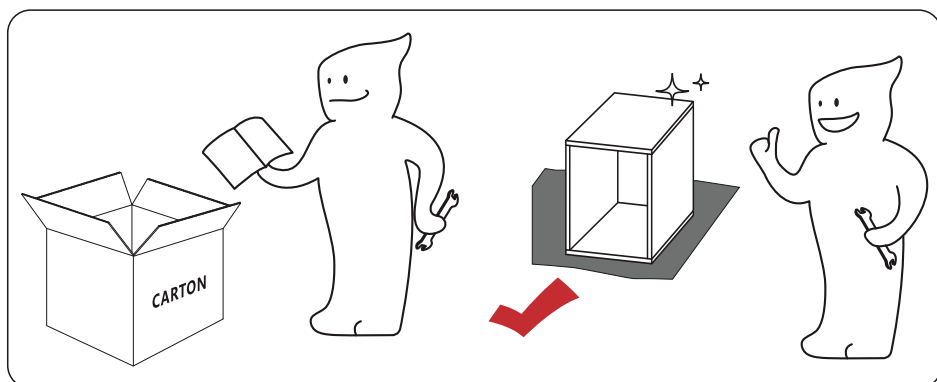
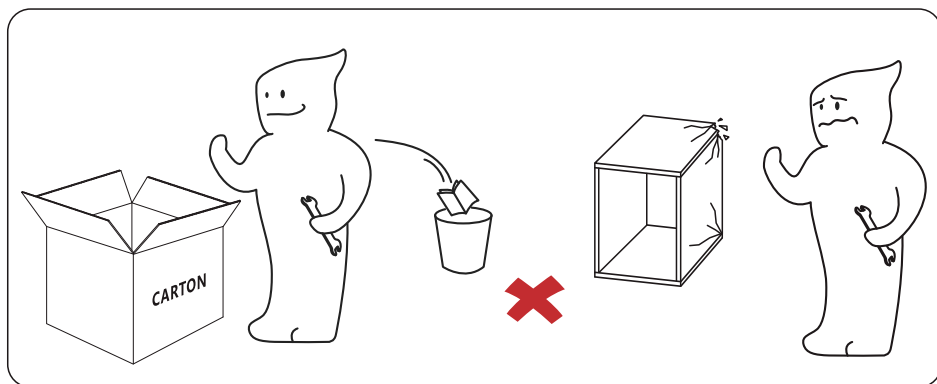

EN - Keep away from fire or other heat sources.
DE - Bitte von Feuer und Hitzequellen fernhalten.
ES - Manténgase alejado de las llamas y otras fuentes de calor.
FR - Tenir à distance des flammes et autres sources de chaleur.
IT - Tenere lontano dal fuoco o da altre fonti di calore.

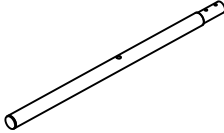
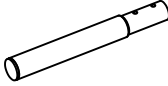
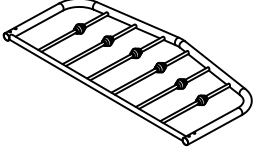
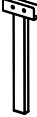
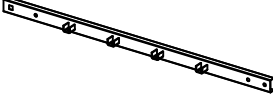
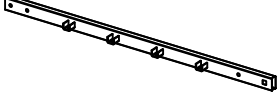
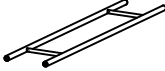
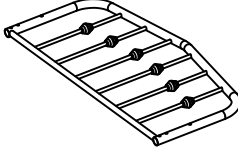
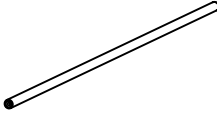

EN - We recommend wearing protective gloves.
DE - Wir empfehlen das Tragen von Schutzhandschuhen.
ES - Recomendamos el uso de guantes de seguridad.
FR - Il est recommandé de porter des gants de protection.
IT - Per il processo di assemblaggio, consigliamo fortemente l'utilizzo di guanti protettivi.

- EN** - Please follow the instruction manuals and use a pad to avoid damage during assembly.
- DE** - Bitte folgen Sie der Anleitung und verwenden Sie eine Unterlage, um Beschädigungen bei der Montage zu vermeiden.
- ES** - Por favor, siga las instrucciones del manual y utilice una cubierta o lona para proteger el producto y el suelo durante la instalación.
- FR** - Suivez les instructions de la notice et utilisez une couverture ou une bâche pour protéger le produit et les sols pendant le montage.
- IT** - Si prega di consultare il manuale illustrativo durante il montaggio e di utilizzare un cuscinetto per evitare possibili danni.

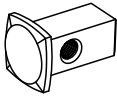
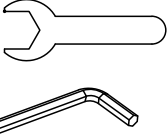

<p>① × 2</p> 	<p>② × 2</p> 	<p>③ × 1</p> 	
<p>④ × 2</p> 	<p>⑤ × 2</p> 	<p>⑥ × 2</p> 	
<p>⑦ × 1</p> 	<p>⑧ × 1</p> 	<p>⑨ × 2</p> 	
<p>⑩ × 8</p> 	<p>Ⓐ × 4</p> 	<p>Ⓑ × 4</p>  <p>35mm</p>	
<p>Ⓒ × 8</p>  <p>40mm</p>	<p>Ⓓ × 12</p> 	<p>Ⓔ × 12</p> 	<p>Ⓕ × 8</p> 
<p>Ⓖ × 4</p> 	<p>Ⓗ × 4</p> 	<p>Ⓖ × 1</p> 	





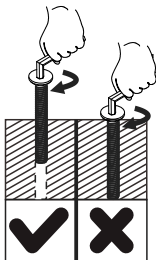

EN - Half tighten the screw
DE - Bitte die Schraube nur halb festziehen
ES - Apretar el tornillo a la mitad
FR - Ne serrez la vis que jusqu'à la moitié
IT - Stringere la vite a metà

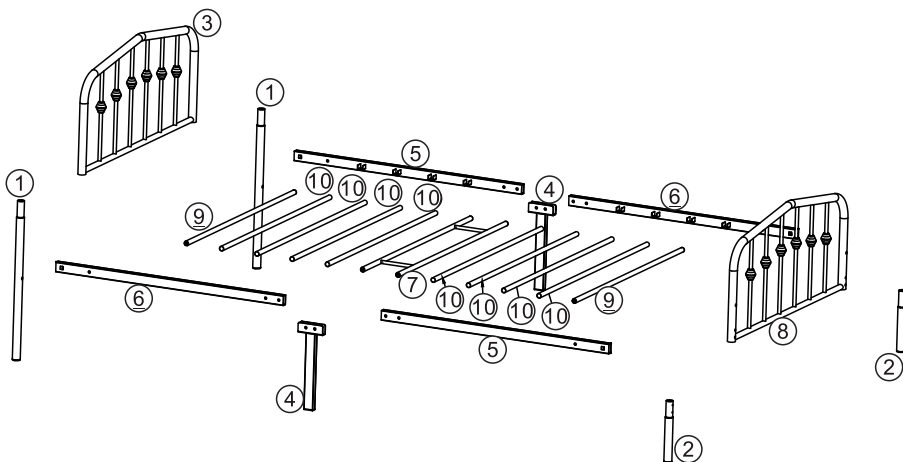
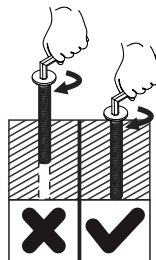

EN - Note: Tighten all screws completely after assembly.
DE - Hinweis: Ziehen Sie nach der Montage alle Schrauben vollständig an.
ES - Nota: Apretar completamente todos los tornillos después de montar.
FR - NB : Serrez les vis complètement après l'assemblage.
IT - Nota: Stringere completamente tutte le viti solo dopo l'assemblaggio.



1

①		x2
③		x1
Ⓓ		x4
Ⓔ		x4

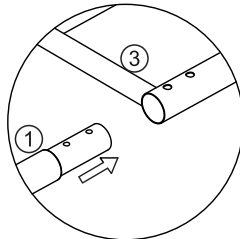
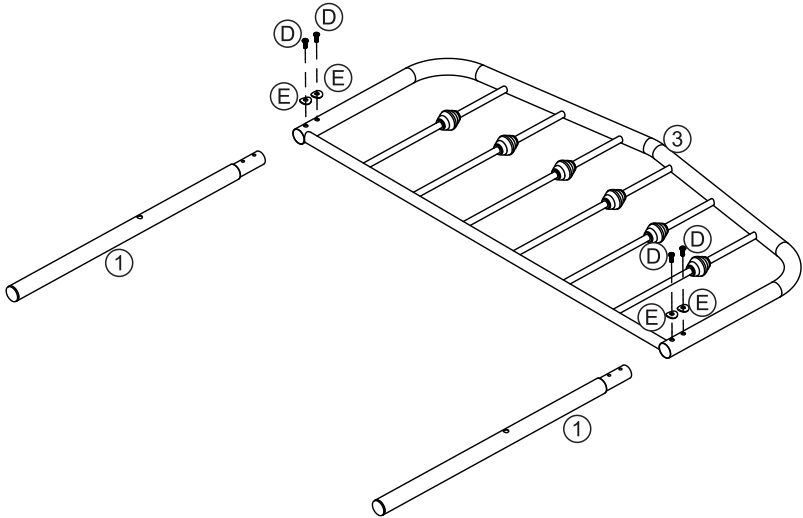
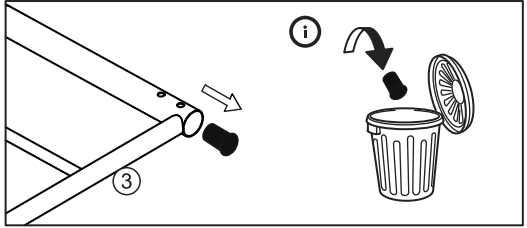



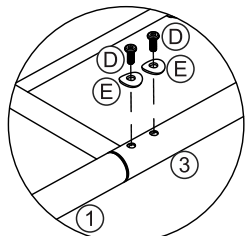

No.1



No.2

2

②		x2
⑧		x1
Ⓓ		x4
Ⓔ		x4

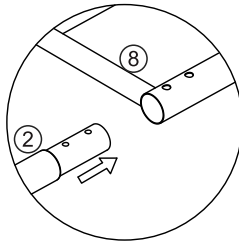
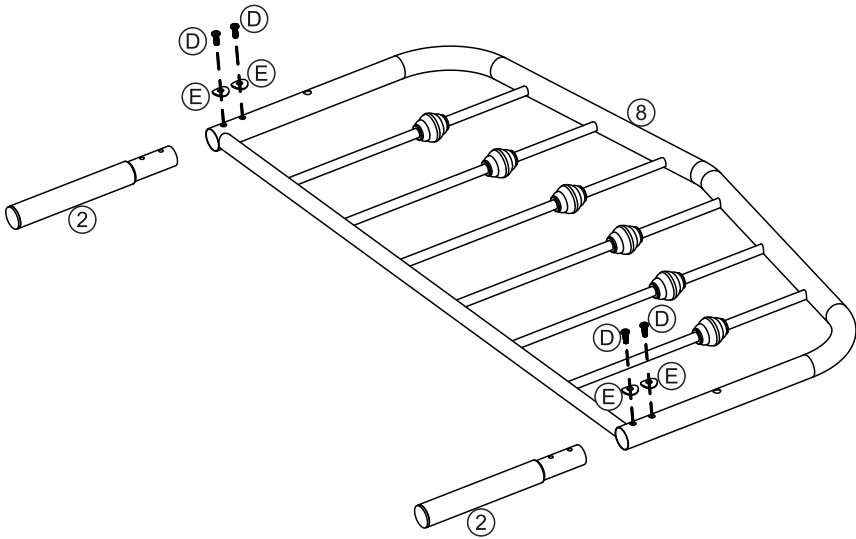
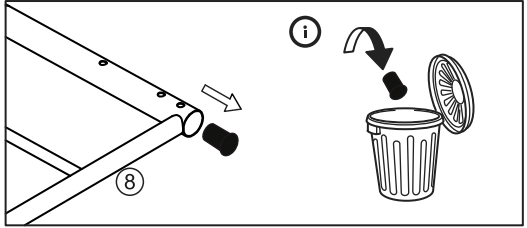



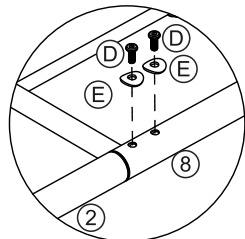



No.1





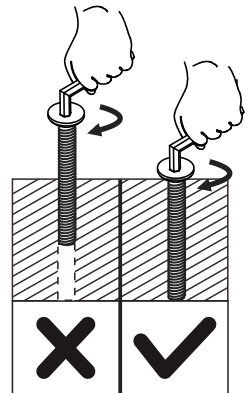
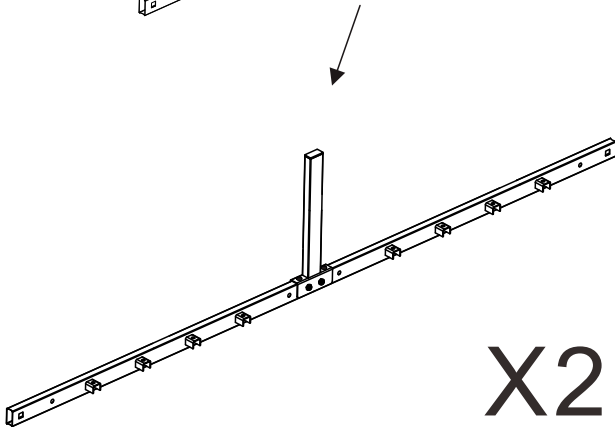
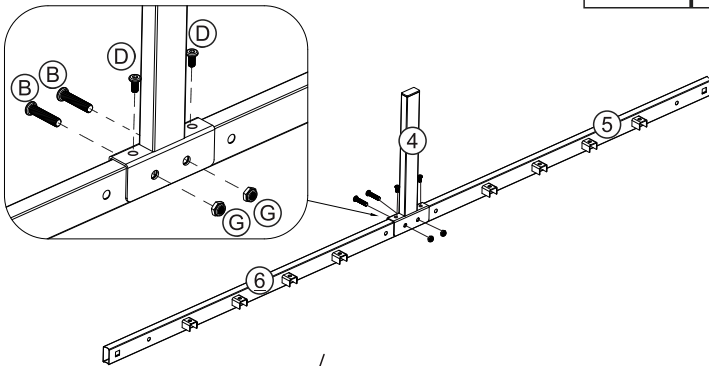
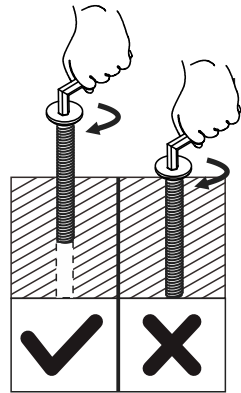

No.2

3

④		x2	⑤		x2	⑥		x2
Ⓑ		x4	Ⓓ		x4	Ⓖ		x4



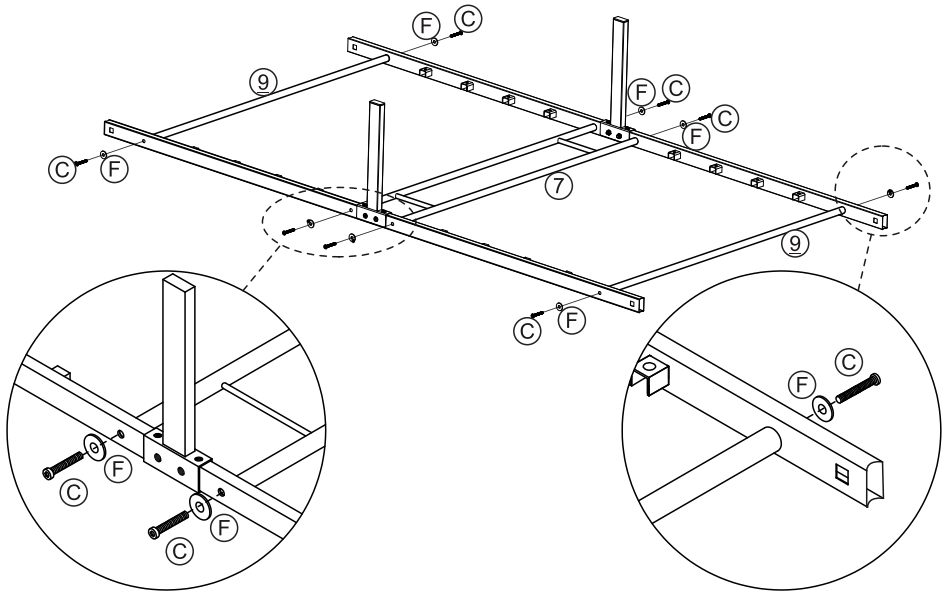
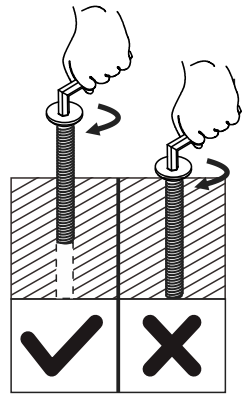

4

⑦		x1
⑨		x2
Ⓒ		x8
Ⓕ		x8



5

(A)		X4
(E)		X4
(H)		X4

EN - Please pay attention to the direction of Part (3)&(8) when installing.
DE - Bitte bei der Montage die Richtung von Teil (3)&(8) beachten.
ES - Por favor preste atención a la dirección de la pieza (3)&(8) al instalar.
FR - Veuillez à bien respecter l'orientation de l'élément (3)&(8) lors du montage.
IT - Si prega di fare attenzione al verso della parte (3)&(8) durante il montaggio.

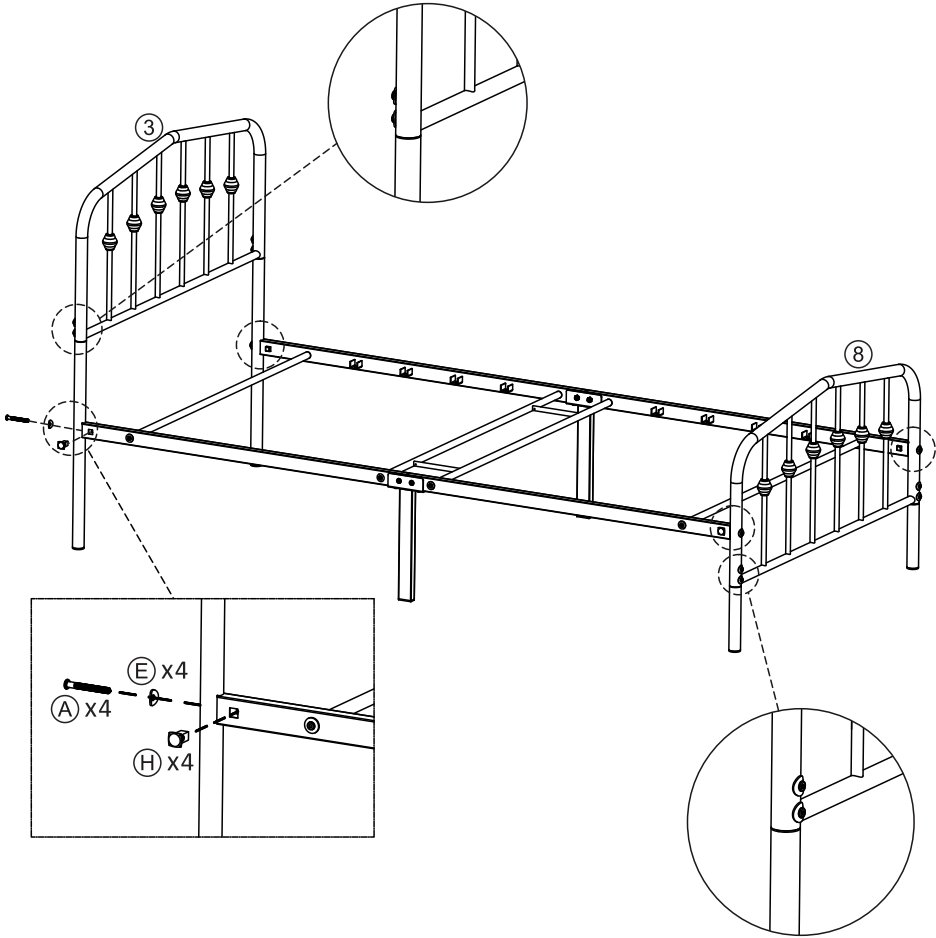

6

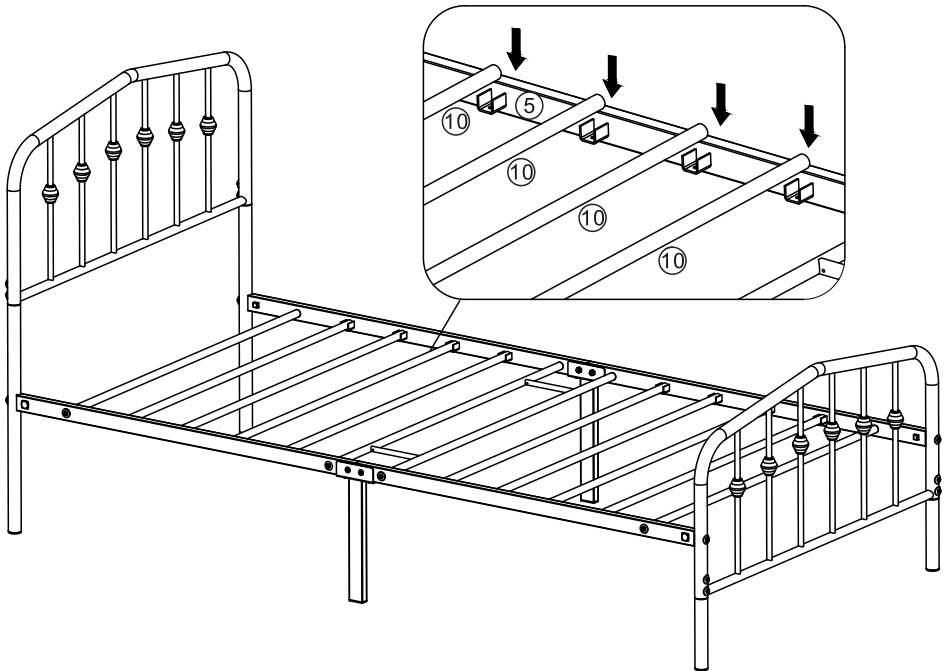
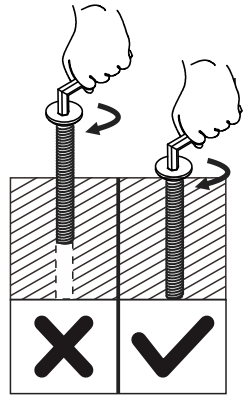
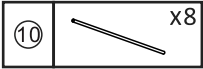

EN : Product Care Instructions

1. Use a soft, clean cloth or sponge to gently wipe the outer surface of the product to remove dust and dirt.
2. Avoid using chemical cleaners or harsh solvents to prevent damage to the appearance of the product.
3. Inspect the fittings (bolts, screws, nuts, etc.) every 3 months and re-tighten them every 6 months.
4. Avoid direct sunlight.

If the product shows structural damage or poses a safety hazard, stop using it until it is repaired.

DE : Pflegehinweise für Produkte

1. Benutzen Sie ein weiches, sauberes Tuch oder einen Schwamm, um behutsam die äußere Oberfläche des Geräts abzuwischen und Staub sowie Schmutz zu entfernen.
2. Vermeiden Sie die Verwendung von chemischen Reinigern oder scharfen Lösungsmitteln, um das Aussehen des Produkts nicht zu beschädigen.
3. Alle 3 Monate sollten Sie die Beschläge wie Bolzen, Schrauben, Muttern usw. überprüfen und alle 6 Monate nachziehen.
4. Es ist ratsam, direkte Sonneneinstrahlung zu vermeiden.

Sollte das Produkt strukturelle Schäden aufweisen oder ein Sicherheitsrisiko darstellen, sollte es nicht mehr verwendet werden, bis es repariert ist.

ES : Instrucciones para Cuidado del Producto

1. Utilizar un paño o una espuma suave y limpia para limpiar ligeramente la superficie exterior del producto y eliminar el polvo y la suciedad.
2. Evitar el uso de limpiadores químicos o disolventes fuertes para evitar dañar la apariencia del producto.
3. Comprobar los herrajes (pernos, tornillos, tuercas, etc.) cada 3 meses y volver a apretarlos cada 6 meses.
4. Evitar la luz solar directa.

Si el producto presenta daños estructurales o posibilidad de peligro para la seguridad, deja de utilizarlo hasta que sea reparado.

FR : Instructions d'entretien du Produit

1. Utilisez un chiffon doux et propre ou une éponge pour essuyer délicatement la surface extérieure du produit afin d'éliminer la poussière et la saleté.
 2. Évitez l'utilisation de produits chimiques de nettoyage ou de solvants agressifs afin de préserver l'apparence du produit.
 3. Inspectez les raccords (boulons, vis, écrous, etc.) tous les 3 mois et resserrez-les tous les 6 mois si nécessaire.
 4. Évitez l'exposition directe aux rayons du soleil.
- Si le produit présente des dommages structurels ou un risque pour la sécurité, cessez de l'utiliser jusqu'à ce qu'il soit réparé.

IT: Istruzioni per la cura del prodotto

1. Utilizzare un panno morbido, pulito o una spugna per pulire delicatamente la superficie esterna del prodotto e rimuovere polvere e sporco.
 2. Evitare l'uso di detergenti chimici o solventi aggressivi per prevenire danni all'aspetto del prodotto.
 3. Controllare le ferramenta (bulloni, viti, dadi, ecc.) ogni 3 mesi e serrarli nuovamente ogni 6 mesi.
 4. Evitare la luce diretta del sole.
- Se il prodotto mostra danni strutturali o rappresenta un pericolo per la sicurezza, smettere di usarlo fino a quando non viene riparato.

EN



If you are not entirely satisfied with your purchase, please feel free to contact us using the following steps:

1. Go to Your Orders.
2. Find your order in the list.
3. Select Problem with order.
4. Choose your topic from list displayed.
5. Select Contact seller.

US:

YAHEE TECHNOLOGIES CORP

Address:1532 S VINEYARD AVE ONTARIO CA 91761

UK:

Monumart Limited

Address: Europa House, Europa Way, IP15DL, Ipswich.

DE



Sollten Sie mit Ihrem Kauf nicht zufrieden sein, nehmen Sie bitte in folgenden Schritten mit uns Kontakt auf:

1. Gehen Sie auf die Bestellseite
2. Suchen Sie Ihre Bestellung in der Bestellliste
3. Schildern Sie das Problem mit der Bestellung
4. Thema aus der angezeigten Liste auswählen
5. Kontakt mit dem Verkäufer aufnehmen.

ES



Si no está totalmente satisfecho con su compra, no dude en ponerse en contacto con nosotros siguiendo las siguientes instrucciones:

1. Vaya a la lista de sus ordenes de compra.
2. Localice su pedido en la lista.
3. Seleccione el problema en el pedido.
4. Elija un tema de la lista que se muestra.
5. Seleccione Contactar con el vendedor.

FR



Si vous n'êtes pas satisfait de votre achat, veuillez nous contacter en procédant comme suit :

1. Allez sur "Vos commandes"
2. Trouvez votre commande dans la liste.
3. Cliquez sur "Signaler un problème"
4. Sélectionnez une catégorie dans la liste déroulante.
5. Cliquez sur "Contactez le vendeur"

IT



Se non siete soddisfatti di questa esperienza dello shopping, non esitate a contattarci per i seguenti passaggi:

1. Vai ai tuoi ordini.
2. Selezionare "l'ordine interessato".
3. Selezionare il problema con l'ordine.
4. Scegli il tuo argomento dalla lista visualizzata.
5. Selezionare "contatta il venditore".

EN - You can also download the electronic Installation Manual from the Product guides and documents section of the advertising page.

DE - Das elektronische Installationshandbuch können Sie auch im Bereich Produktführungen und Dokumente der Werbeseite herunterladen.

ES - También puede descargar el Manual de instalación electrónica de la Guía del producto y la Sección de documentación de la página de anuncios.

FR - Vous pouvez également télécharger le manuel d'installation électronique à partir de la section Guide produit et documentation de la page publicitaire.

IT - È inoltre possibile scaricare il manuale di installazione elettronico dalla guida del prodotto e dai documenti nella pagina pubblicitaria.

Hergestellt in PRC für Yahee GmbH

Yahee GmbH Höpfigheimer Straße 11, 74321 Bietigheim-Bissingen

E-Mail: info@yaheetech.shop