

SIDE CHAIR

ASSEMBLY INSTRUCTIONS

INSTRUCTION D'ASSEMBLAGE

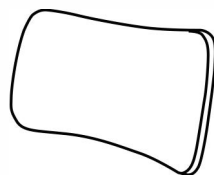
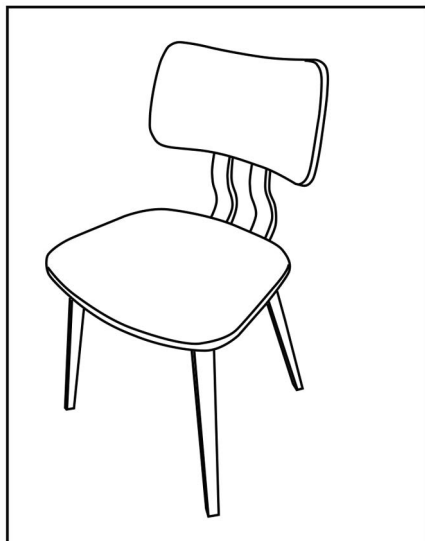

A

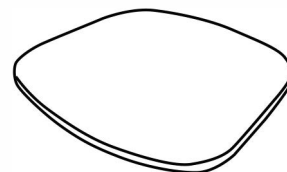

B

Cx2





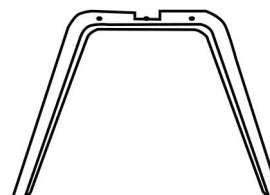
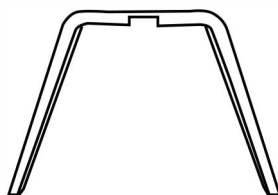

D

E



TURN TOP UPSIDE DOWN ON A SOFT WORKING SURFACE.

RETOURNEZ LE MEUBLE DANS L' AUTRE SENS SUR UNE SURFACE DE TRAVAIL NON RIGIDE.

<p>a M6*20MM</p>  <p>4+1 pcs/unites</p>	<p>b M6*30MM</p>  <p>4+1 pcs/unites</p>	<p>c M6*25MM</p>  <p>1+1 pcs/unites</p>	<p>d M6*42MM</p>  <p>4+1 pcs/unites</p>
<p>e M6*14*1MM</p>  <p>13+1 pcs/unites</p>	<p>f</p>  <p>4 pcs/unites</p>	<p>g</p>  <p>2 pcs/unites</p>	

STEP 1 / ÉTAPE 1

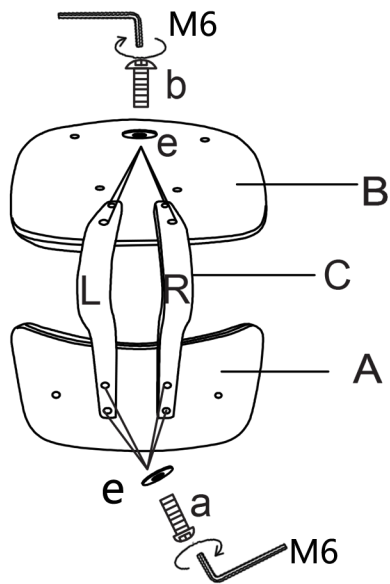

STEP 2 / ÉTAPE 2

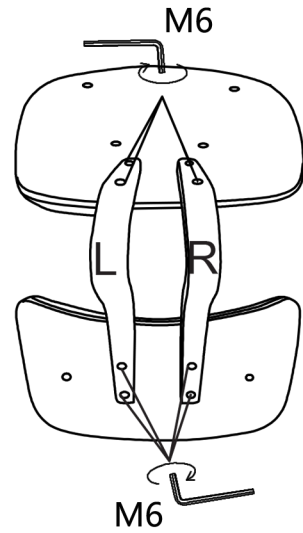

STEP 3 / ÉTAPE 3

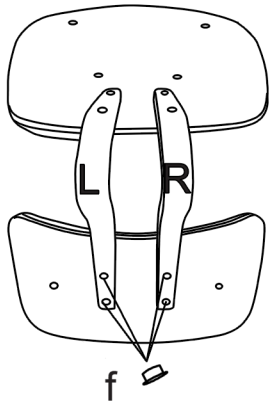

STEP 4 / ÉTAPE 4

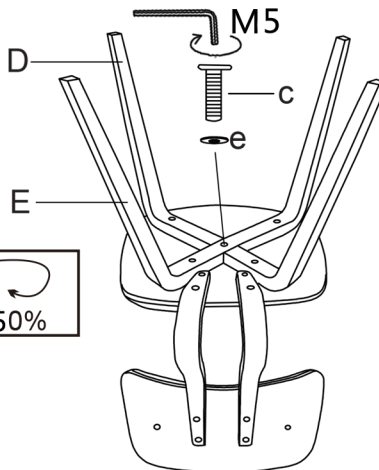

STEP 5 / ÉTAPE 5

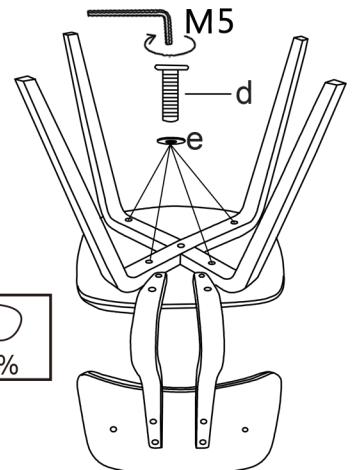
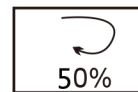

STEP 6 / ÉTAPE 6

