

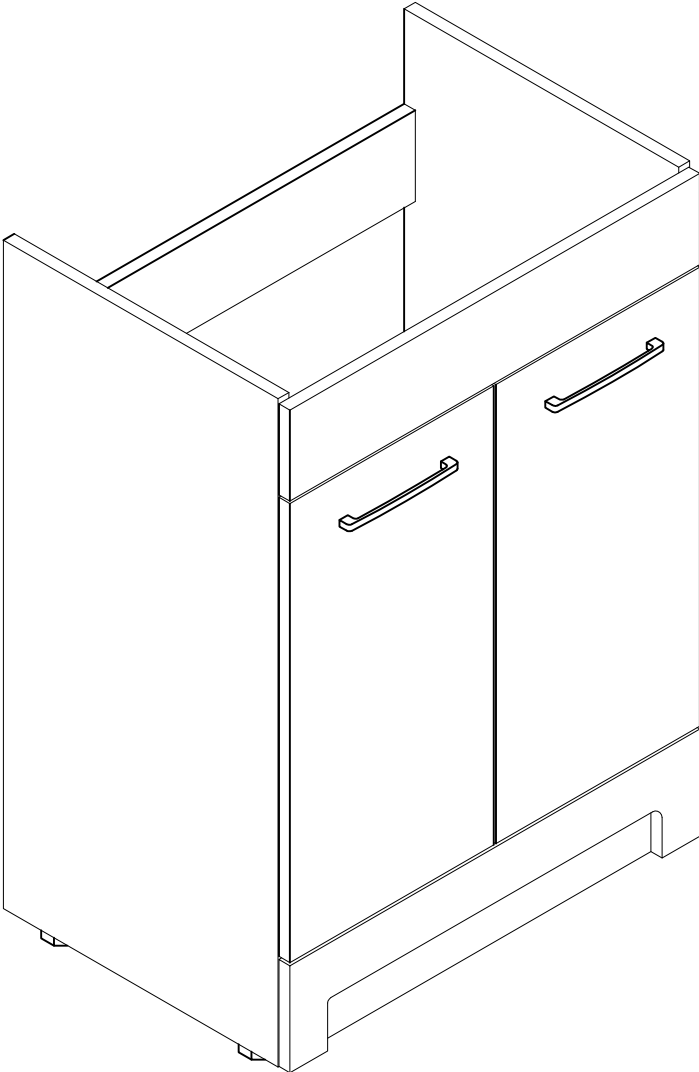

US44

DIMENSIONS



YOU MAY NEED (NOT SUPPLY)

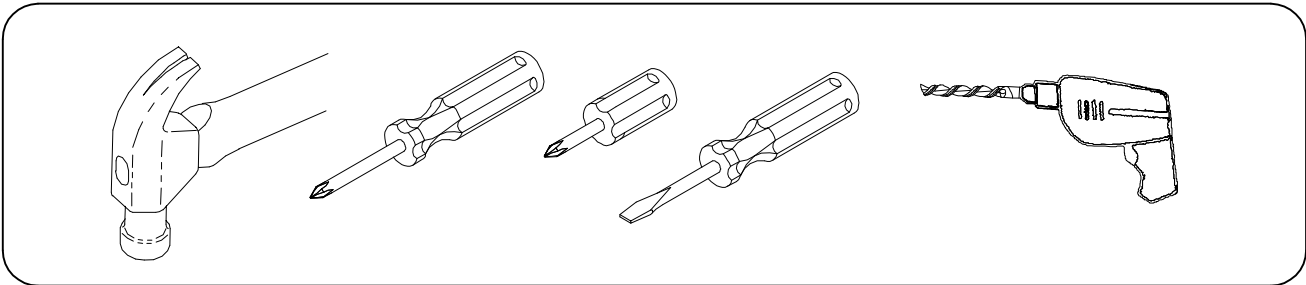



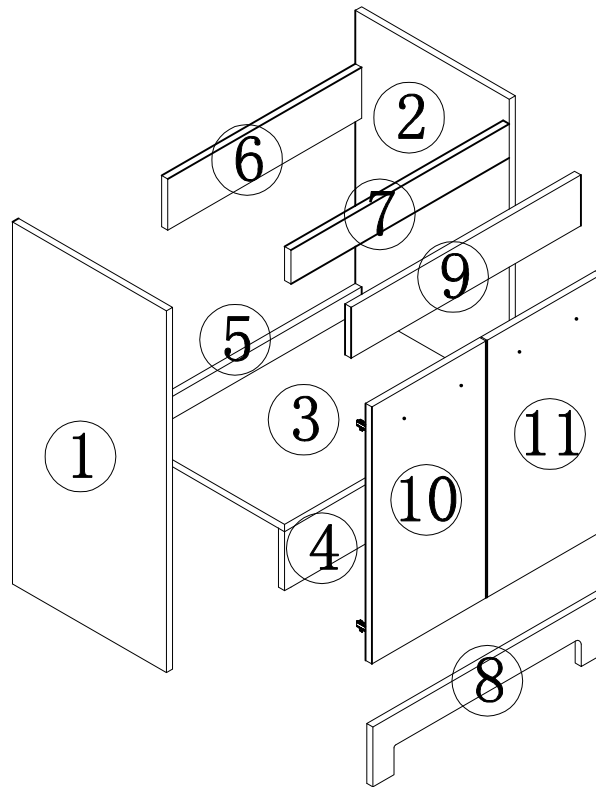







ASSEMBLY DIAGRAM











PARTS LIST

PARTS LIST

NO	DESCRIPTION	QTY	NO	DESCRIPTION	QTY
①	Left side panel 	1	⑧	Bottom outside front panel 	1
②	Right side panel 	1	⑨	Upper front end panel 	1
③	Bottom panel 	1	⑩	Left door panel 	
④	Bottom inside front panel 	1	⑪	The right door 	
⑤	rear drop down 	1			
⑥	Upper back panel 	1			
⑦	Long front panel 	1			

PARTS LIST

HARDWARE LIST

NO	DESCRIPTION	QTY	NO	DESCRIPTION	QTY
A	Three-in-one eccentric wheel 	28	G	4*23mm screw 	4
B	Three-in-one connecting rod 	28	H	Door Handle 	2
C	Three-in-one sticker 	28			
D	8*40mm wood dowel pins 	8			
E	Door hinge 	4			
F	4*16mm screw 	24			

CAUTION:

Please confirm the parts list before installation

STEP 1

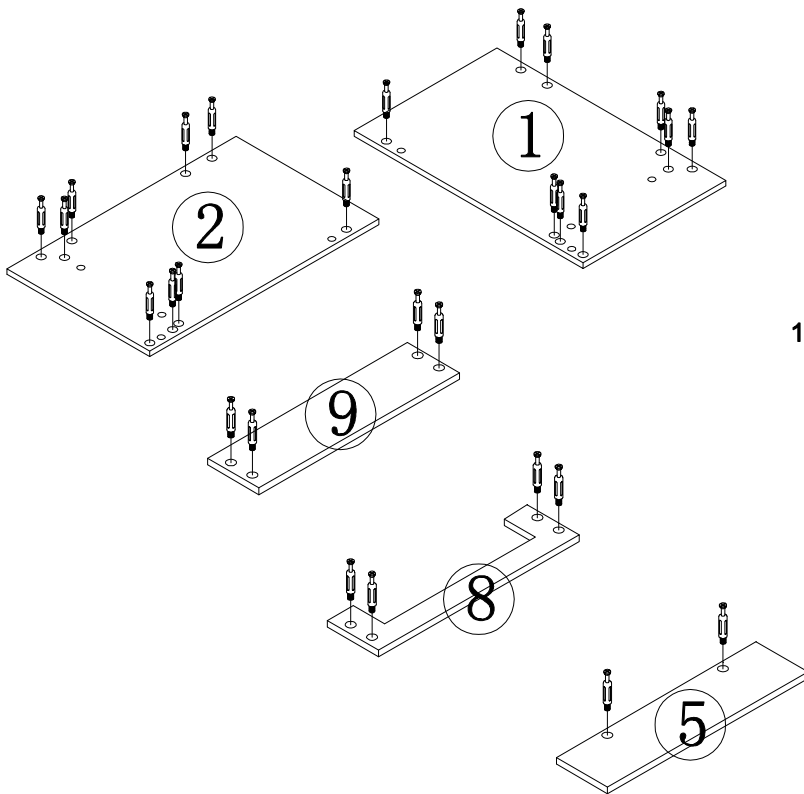

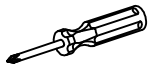
HARDWARE LIST	
Three-in-one connecting rod B  28 PCS	

1. Put the three-in-one connecting rod in the $\varnothing 10\text{mm}$ hole of the following panels and tighten them with a cross screwdriver or an electric tool.

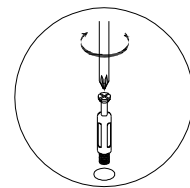

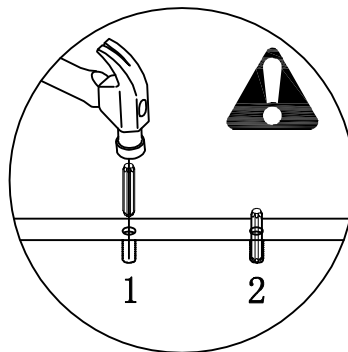

STEP 2

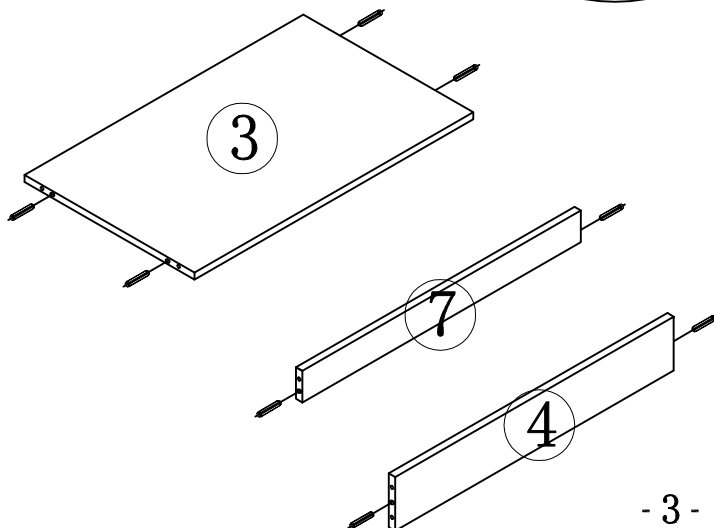

1. Strike the $\varnothing 8 \times 40\text{mm}$ wood dowel pin into the $\varnothing 8\text{mm}$ hole of the above panels with an iron hammer. Please note that the hole of the three-in-one connecting rod should also be 8mm. The hole of the three-in-one connecting rod connects to the hole of $\varnothing 15\text{mm}$ three-in-one eccentric wheel.



HARDWARE LIST	
8*40mm wood dowel pins D  8 PCS	

STEP 3

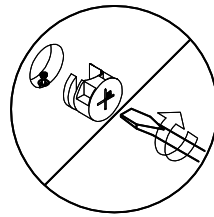
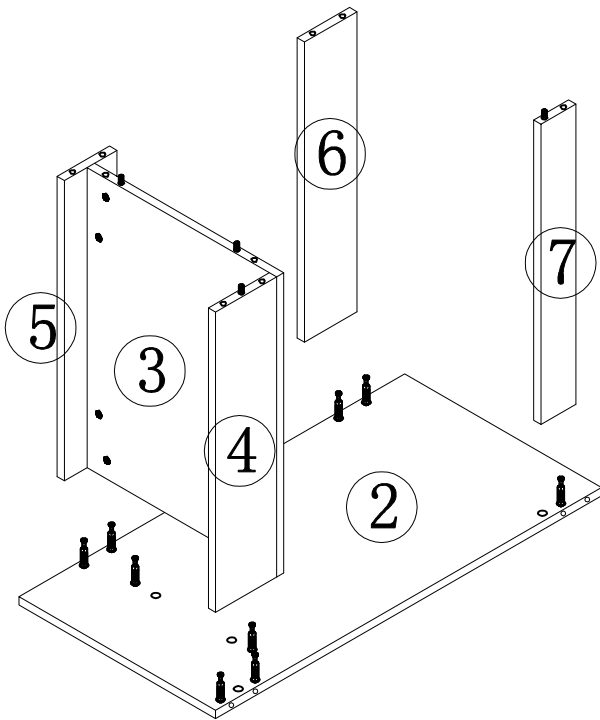

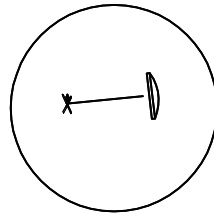

1. Connect No. 3-4-5-6-7 panel to No.2 panel tightly with the three-in-one eccentric wheel.



2. Cover the mounting hole of the eccentric wheel with a three-in-one sticker.

HARDWARE LIST

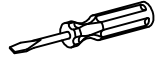
Three-in-one eccentric wheel A  9 PCS	Three-in-one sticker C  9 PCS	
---	---	---

STEP 4

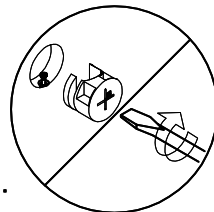
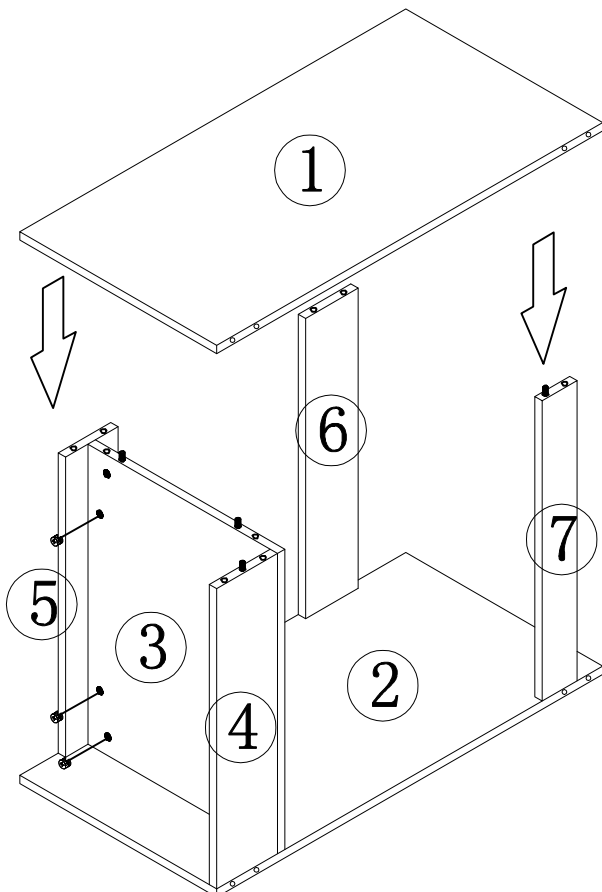

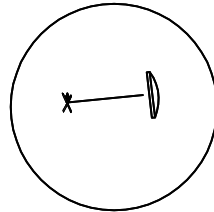

1. Connect No. 3-4-5-6-7 panel to No.2 panel tightly with the three-in-one eccentric wheel.



2. Cover the mounting hole of the eccentric wheel with a three-in-one sticker.

HARDWARE LIST

Three-in-one eccentric wheel A  9 PCS	Three-in-one sticker C  9 PCS	
---	---	---

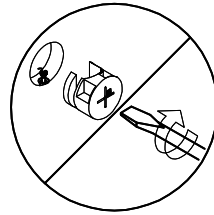
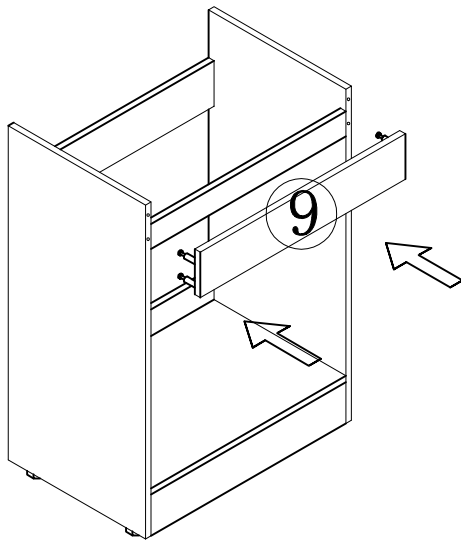

STEP 5

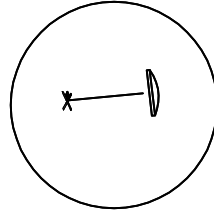

1. Install No.6 panels with the three-in-one eccentric wheel tightly.



2. Cover the mounting hole of the eccentric wheel with a three-in-one sticker.

HARDWARE LIST		
Three-in-one eccentric wheel A  4PCS	Three-in-one sticker C  4PCS	

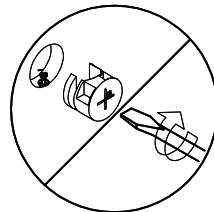
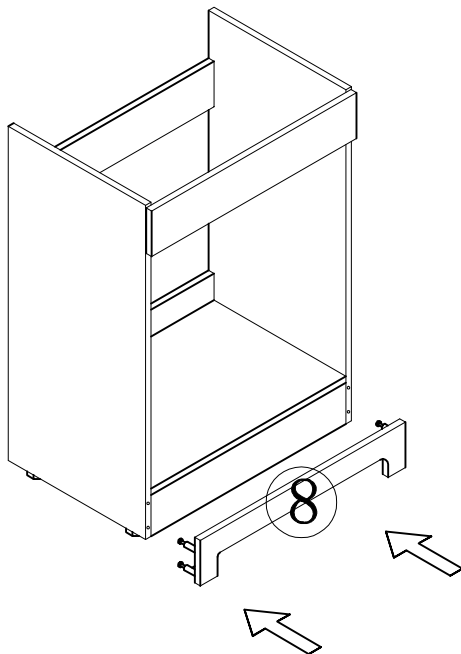

STEP 6

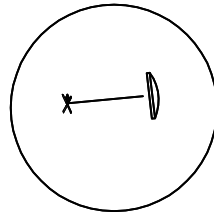

1. Install No.6 panels with the three-in-one eccentric wheel tightly.



2. Cover the mounting hole of the eccentric wheel with a three-in-one sticker.

HARDWARE LIST		
Three-in-one eccentric wheel A  4PCS	Three-in-one sticker C  4PCS	

STEP 7

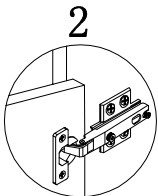
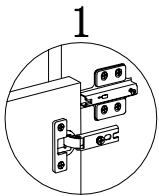
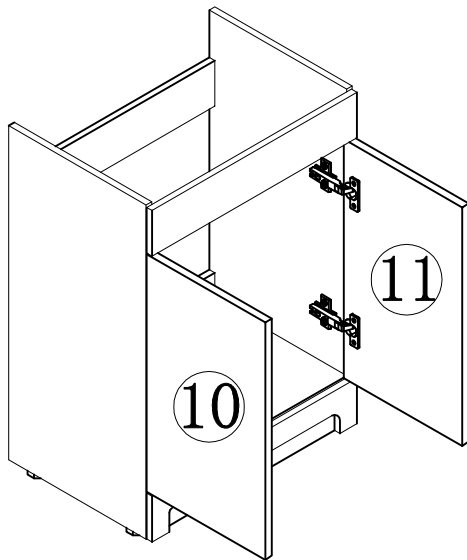

3. Install the hinge cup on the door panel to the hinge of the side panel.

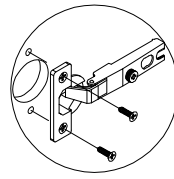

1. Install the hinge cup to the door panel with 4*16mm screws.

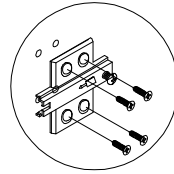

2. Install the hinge to the side panel with 4*16mm screws.

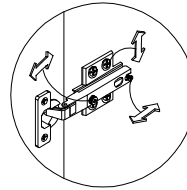

4. Adjust the door panel clearance.

HARDWARE LIST

4*16mm screw	Door hinge	
F  24PCS	E  4PCS	

STEP 8

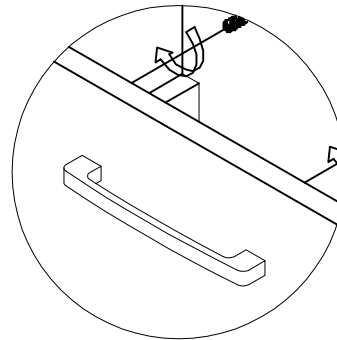
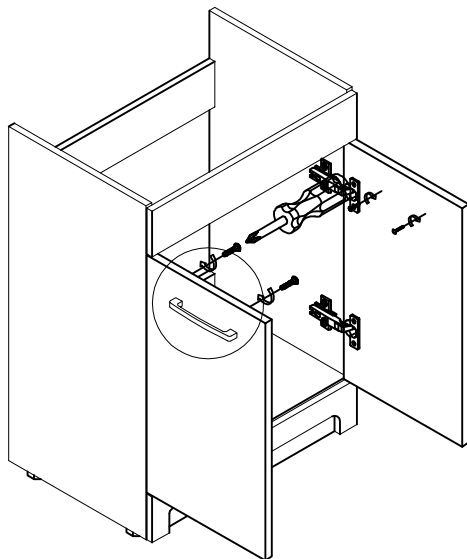

Install the door handle with 4*23mm handle screws.

HARDWARE LIST

4*23mm screw	Door handle	
G  4PCS	H  2PCS	



Choking hazard-Small Parts : This unit contains small parts, not for children under 3 years.

Tip-over hazard : Secure finished unit to wall stud using L-Bracket and wall screw (#10*1.5"W/out provided). If a wall stud is not neccessible , Consault your local hardware store for appropriate mounting hardware . Failure to properly install will result in product collapse or tip-over. Serious injury can occur .