

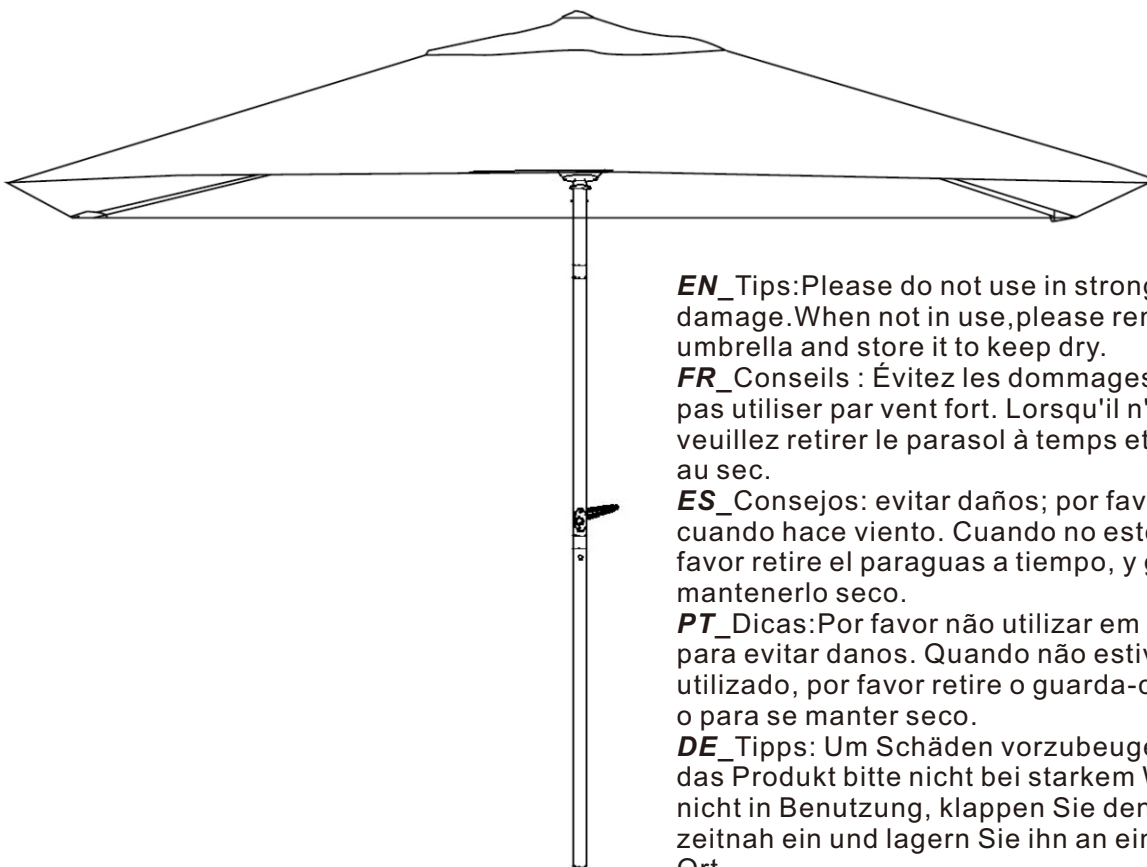

IN221100884V01\_GL

84D-158\_84D-158V00\_84D-158V01



**EN\_Tips:** Please do not use in strong winds to avoid damage. When not in use, please remove the umbrella and store it to keep dry.

**FR\_Conseils :** Évitez les dommages, veuillez ne pas utiliser par vent fort. Lorsqu'il n'est pas utilisé, veuillez retirer le parasol à temps et conservez-le au sec.

**ES\_Consejos:** evitar daños; por favor, no use cuando hace viento. Cuando no esté en uso: por favor retire el paraguas a tiempo, y guárdelo para mantenerlo seco.

**PT\_Dicas:** Por favor não utilizar em ventos fortes para evitar danos. Quando não estiver a ser utilizado, por favor retire o guarda-chuva e guarde-o para se manter seco.

**DE\_Tipps:** Um Schäden vorzubeugen, nutzen Sie das Produkt bitte nicht bei starkem Wind. Wenn nicht in Benutzung, klappen Sie den Schirm bitte zeitnah ein und lagern Sie ihn an einem trockenen Ort.

**IT\_Suggerimenti:** evitare danni, si prega di non utilizzare quando fuori C'è vento. Quando non in uso, si prega di rimuovere l'ombrello tempestivamente e conservare per tenerlo asciutto.

**EN\_IMPORTANT, RETAIN FOR FUTURE REFERENCE: READ CAREFULLY.**

**FR\_IMPORTANT: A LIRE ATTENTIVEMENT ET À CONSERVER POUR CONSULTATION ULTÉRIEURE.**

**ES\_IMPORTANTE, LEA Y GUARDE PARA FUTURAS REFERENCIAS.**

**PT\_IMPORTANTE, RETER PARA REFERÊNCIA FUTURA: LEIA ATENTAMENTE.**

**DE\_WICHTIG! SORGFÄLTIG LESEN UND FÜR SPÄTER NACHSCHLAGEN AUFBEWAHREN.**

**IT\_IMPORTANTE! CONSERVARE IL PRESENTE MANUALE PER FUTURO RIFERIMENTO E LEGGERLO ATTENTAMENTE.**

**A** x 1

**B** x 1

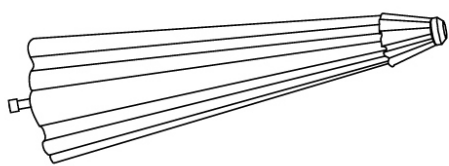

**01**

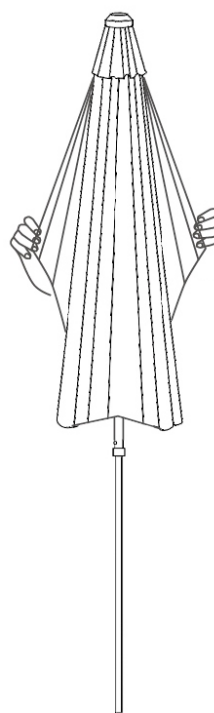
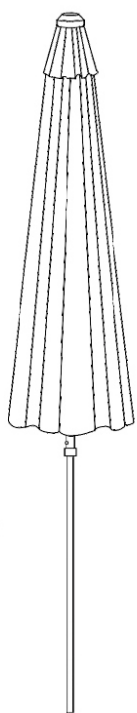
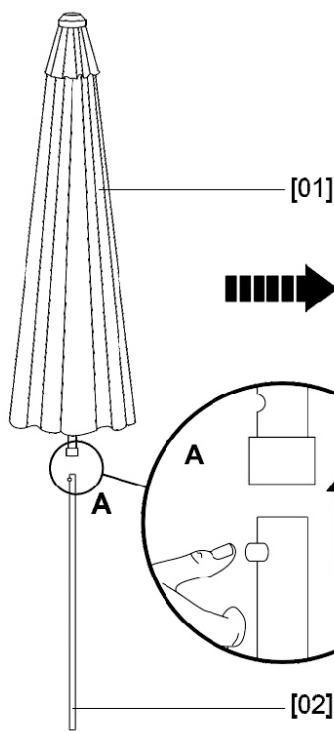

**EN** Before open the umbrella, pls stretch the short ribs out to ensure it did not stuck in.

**FR** Avant d'ouvrir le parapluie, étirez les côtes courtes pour vous assurer qu'elles ne sont pas coincées.

**ES** Antes de abrir el paraguas, estire las costillas para asegurarse de que no se atascan.

**DE** Bevor Sie den Schirm öffnen, strecken Sie die kurzen Rippen aus, um sicherzustellen, dass sie nicht eingeklemmt sind.

**IT** Prima di aprire l'ombrello, allungare le costole per assicurarsi che non rimangano incastrate.

**02**

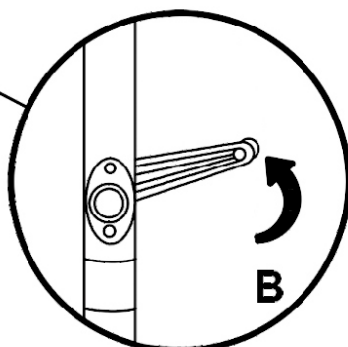
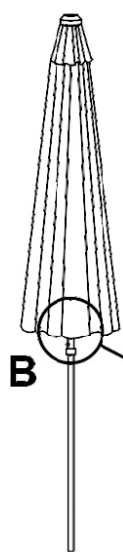

**Done**

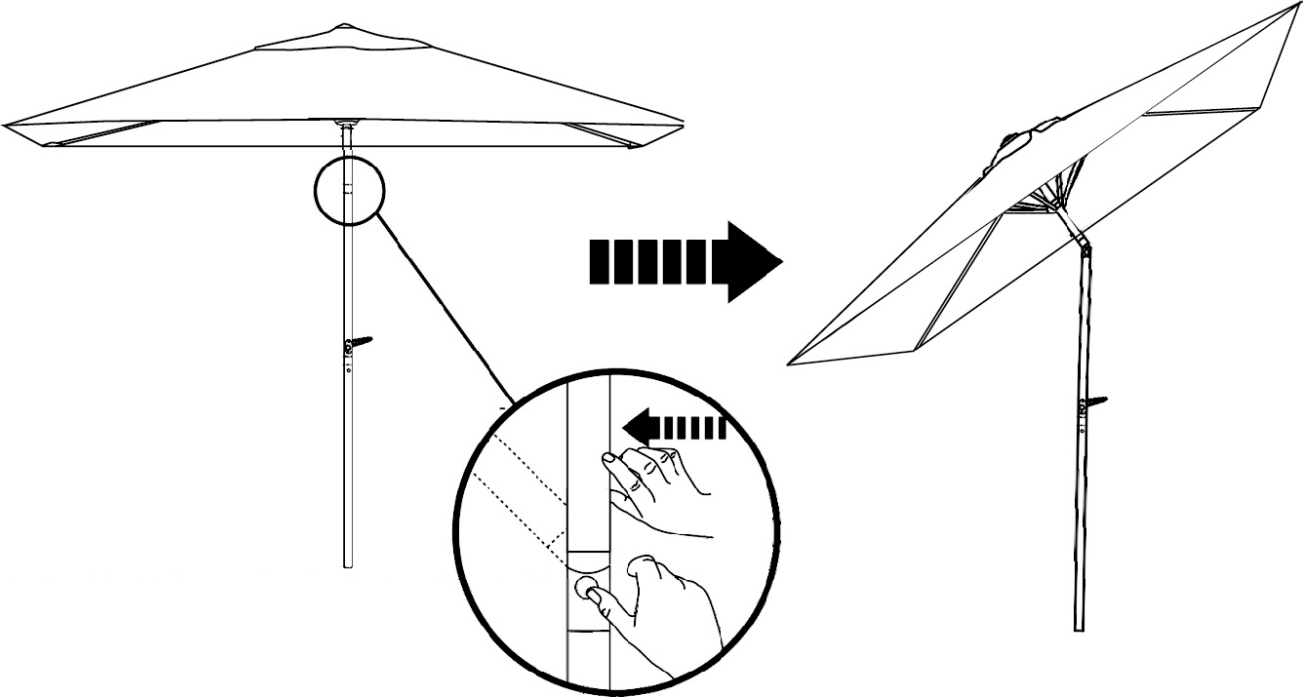

If you have any questions, please contact our customer care center, Our contact details are below:

**US**

 001-877-644-9366

 customerservice@aosom.com

Imported by Aosom LLC  
27150 SW Kinsman Rd Wilsonville, OR 97070 USA  
MADE IN CHINA

If you have any questions, please contact our customer care center, Our contact details are below:

**CA**

 416-792-6088

 customerservice@aosom.ca

Imported by Aosom Canada Inc.  
7270 Woodbine Avenue, Unit 307, Markham,  
Ontario Canada L3R 4B9  
MADE IN CHINA

Si vous avez la moindre question, veuillez contacter notre centre d'assistance à la clientèle, Nos coordonnées sont les suivantes:

 416-792-6088

 customerservice@aosom.ca

Importé par Aosom Canada Inc.  
7270 Woodbine Avenue, unité 307,  
Markham, Ontario Canada L3R 4B9  
FABRIQUÉ EN CHINE

If you have any questions, please contact our customer care center, Our contact details are below:

**UK**

 0044-800-240-4004

 enquiries@mhstar.co.uk

IMPORTER ADDRESS:  
MH STAR UK LTD  
Unit 27, Perivale Park,  
Horsenden lane South  
Perivale, UB6 7RH  
MADE IN CHINA

Si vous avez la moindre question, veuillez contacter notre centre d'assistance à la clientèle, Nos coordonnées sont les suivantes:

**FR**

 0033-1-84166106

 aosom@mhfrance.fr

Importé par/Fabricant/REP:  
MH FRANCE  
2 Rue Maurice Hartmann  
92130 Issy Les Moulineaux  
France  
FABRIQUÉ EN CHINE

Wenn Sie Fragen haben, wenden Sie sich bitte an unser Kundendienstzentrum, Unsere Kontaktdaten stehen unten:

**DE**

 0049-0(40)-88307530

 service@aosom.de

ADRESSE DES IMPORTEUR/Hersteller/REP:  
MH Handel GmbH  
Wendenstraße 309  
D-20537 Hamburg  
Germany  
IN CHINA HERGESTELLT

In caso di dubbio, si prega di contattare il nostro centro assistenza clienti, I nostri dettagli di contatto sono di seguito:

**IT**

 0039-0249471447

 clienti@aosom.it

IMPORTATO DA/Produttore/REP:  
AOSOM Italy srl  
Centro Direzionale Milanofiori  
Strada 1 Palazzo F1  
20057 Assago (MI)  
P.I.: 08567220960  
FATTO IN CINA

Si tiene alguna pregunta, comuníquese con nuestro Centro de Atención al Cliente, Nuestros datos de contacto son los siguientes:

**ES**

 0034-931294512

 atencioncliente@aosom.es

IMPORTADOR/Fabricante/REP:  
SPANISH AOSOM, S.L.  
C/ROC GROS, N°15.08550, ELS HOSTALETS DE  
BALENYÀ, SPAIN.  
B66295775  
HECHO EN CHINA

Se tiver alguma dúvida, por favor contacte o nosso Centro de Atendimento ao Cliente, Os nossos dados de contacto são os seguintes:

**PT**

 0034-931294512

 info@aosom.pt.

IMPORTADOR/Fabricante/REP:  
SPANISH AOSOM, S.L.  
C.ROC GROS N.15, 08550. ELS HOSTALETS DE  
BALENYÀ  
FEITO NA CHINA



**FR**

**DONNEZ  
OU  
RECYCLEZ**



ASSOCIATION

OU



LIVRAISON

OU



DÉCHÈTERIE

Adresses sur [quefairedemesdechets.fr](http://quefairedemesdechets.fr)