

USER'S MANUAL

TV STAND

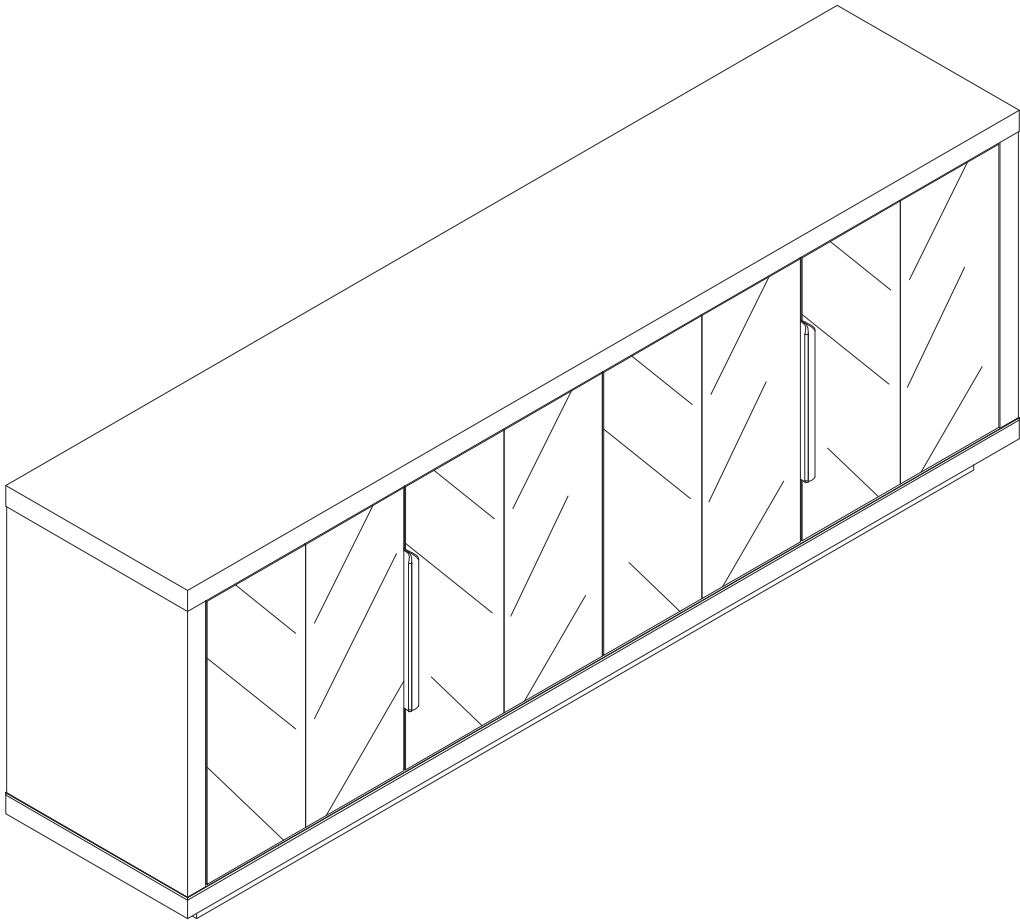

Guide of Manual

- Thanks for your choice. **We will do our best to provide customer service for everyone.**
- Please check to make sure all parts are included as stated when you unpack. If there are parts missing or wrong, please contact us, **we will expeditiously provide reissue accessories, compensation or other services.**
- Instruction should be read carefully. But the manual may not cover every detail of all possible situations and steps. **Please contact us if further information and help are needed. We will respond in a timely manner.**
- **Please be patient that the other items are on the way if you buy more than one product.**

Warning

- It's kindly advised to assemble this product on a carpeted floor to protect it from being scratched.
- Small parts are included. Please keep the product away from children while assembling. Do not let children play or jump on the product. Do not stand on the item or use as a step ladder.
- Please pay attention to the sharp corners during assembly. We recommend the use of gloves to prevent the undesired injury.
- Prior to use, please check to see if there's any loosening screw or part. Make sure that each screw and part is correctly installed and securely fastened.
- It's unnecessary to use electric drill. Please at a low gear if you need.

Care and Maintenance

- Use a soft, clean cloth that will not scratch the surface when dusting.
- There' s no need to use furniture polish. If you need, test it first in an inconspicuous area. Using solvents of any kind on your furniture may damage the finish. Never use water to clean your furniture as it may cause damage to the finish.
- Liquid spills should be removed immediately. Gently blot the spill with a soft clean cloth to avoid rubbing.

Further Advice about the Furniture Care

- It is best to keep your furniture in a climate-controlled environment.
- We recommend to keep furniture from sunlight exposure to avoid possible surface damage.
- Following these important and helpful tips will help retain your furniture's performance even when it ages.
- Periodically (every 90 days) make sure the screws are fully tightened.

Max Weight Capacity

- 250lbs [Do not stand on the item]

Parts List

Make sure parts are in the package

① x 1pc
Top panel

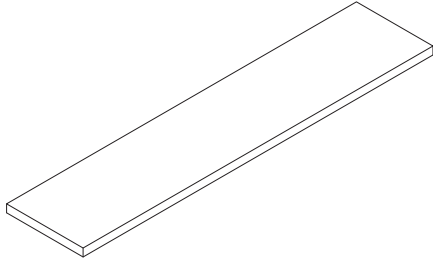

② x 1pc
Left side panel

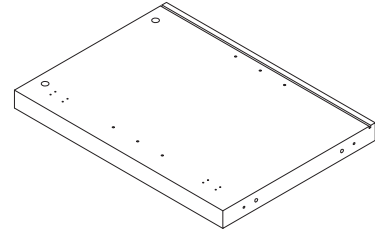

③ x 1pc
Right side panel

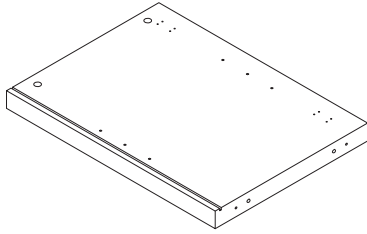

④ x 1pc
Bottom panel

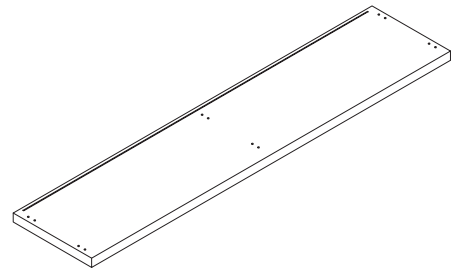

⑤ x 1pc
Partition panel

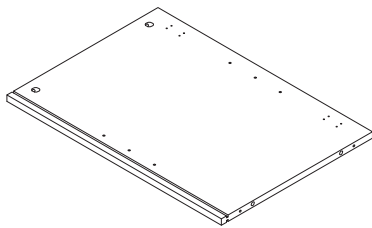

⑥ x 2pcs
Adjustable shelves

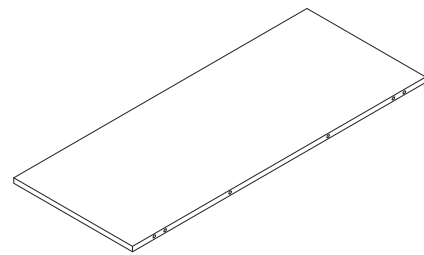

⑦ x 2pcs
Front crossbar of the activity shelves

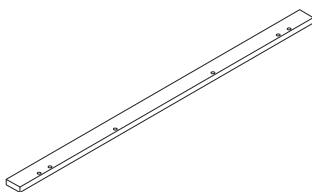

⑧ x 4pcs
Back panels

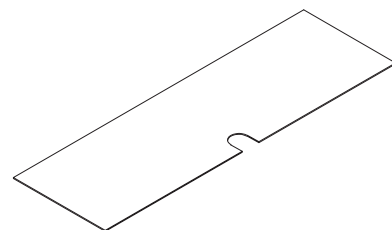

Parts List

Make sure parts are in the package

⑨ x 2pcs

H-shaped plastic strips

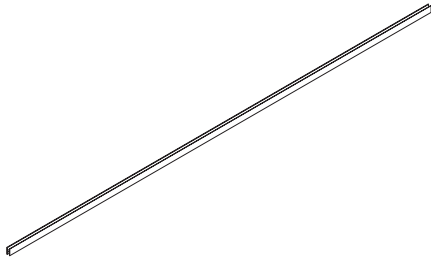

⑩ x 2pcs

Front and back aprons

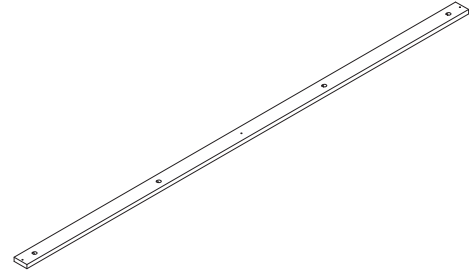

⑪ x 3pcs

Side aprons

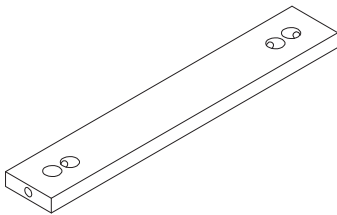

⑫ x 2pcs

Left doors

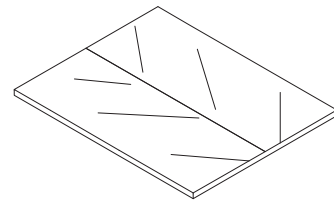

⑬ x 1pc

Middle left door

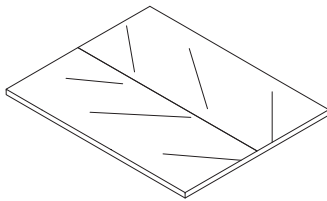





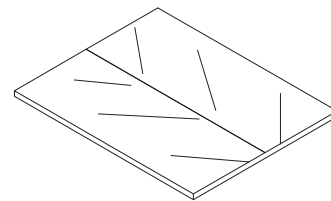

⑭ x 1pc

Middle Right door

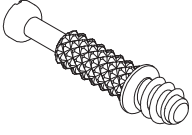

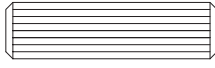

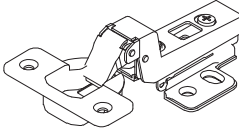
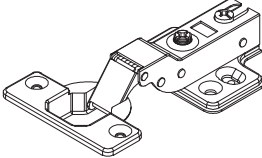

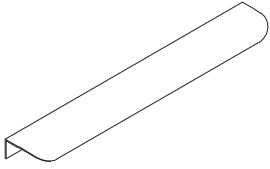
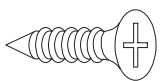
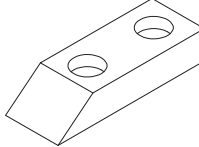
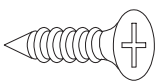

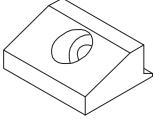
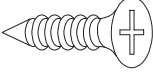

Hardware List

"+ in below list indicates that additional pieces are replacement parts"

<p>A x 34+2pcs</p>  <p>Cam bolts M6*35mm</p>	<p>B x 34+2pcs</p>  <p>Cam locks Ø15*11.5mm</p>	<p>C x 26+2pcs</p>  <p>Wood dowels Ø8*30mm</p>
<p>D x 6+1pcs</p>  <p>Screws Ø6*50mm</p>	<p>E x 8+2pcs</p>  <p>Shelf support pins</p>	<p>F x 4pcs</p>  <p>Large radian curved doors hinge (Inbuilt) Ø35mm</p>
<p>G x 4pcs</p>  <p>Moderate curved door hinges (Half cover) Ø35mm</p>	<p>H x 48+2pcs</p>  <p>Flat head screws Ø3.5*15mm</p>	<p>I x 4pcs</p>  <p>Handles 300*40*17mm</p>
<p>J x 8+2pcs</p>  <p>Flat head screws Ø3.5*12mm</p>	<p>K x 2pcs</p>  <p>Door stoppers 40*15*8mm</p>	<p>L x 4+1pcs</p>  <p>Flat head screws Ø3*15mm</p>

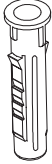

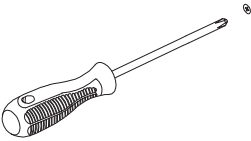
Hardware List

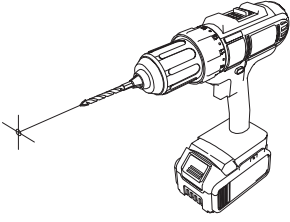
"+ in below list indicates that additional pieces are replacement parts"

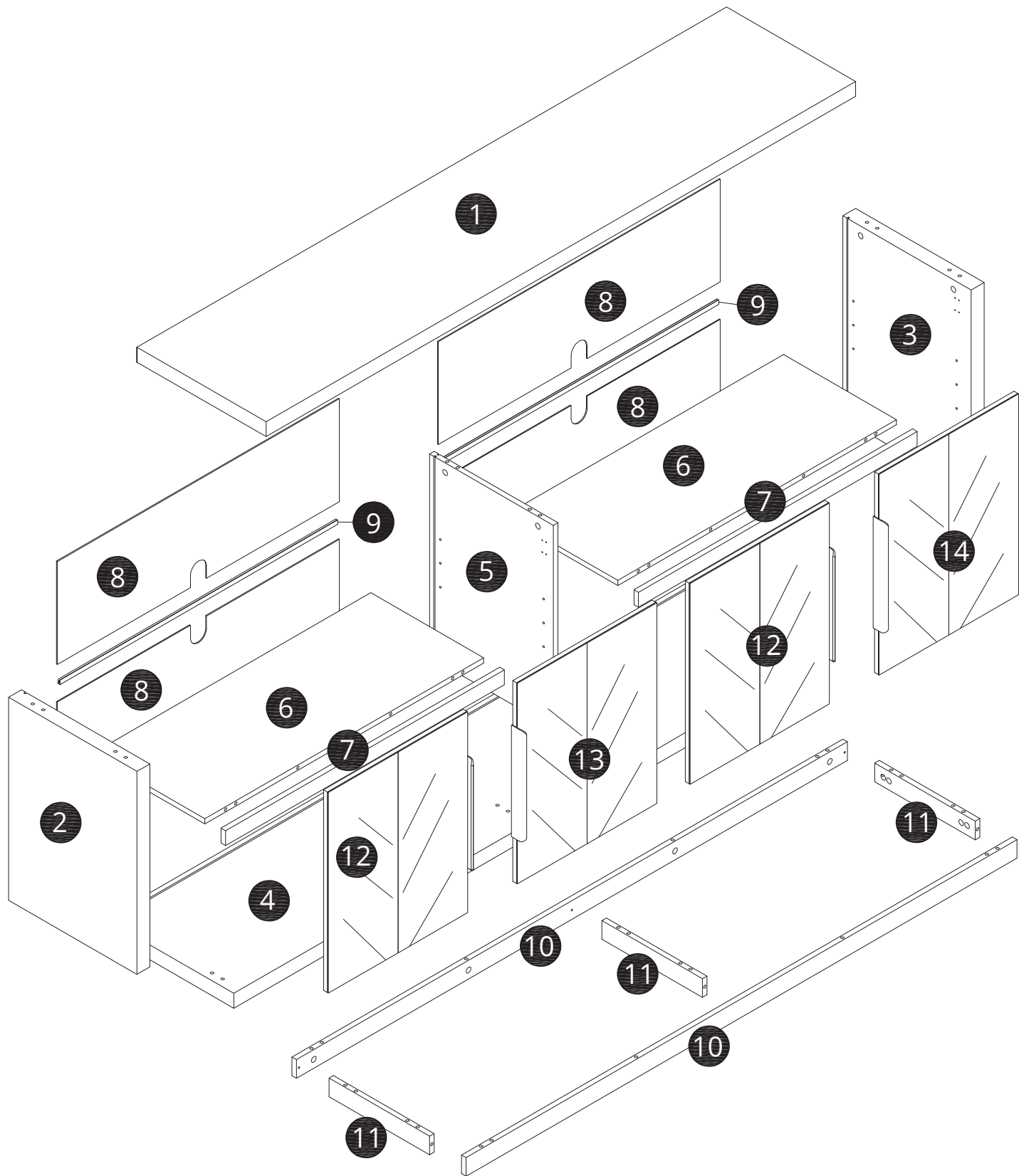
<p>M x 20+2 pcs</p>  <p>Plastic wedges</p>	<p>N x 20+2 pcs</p>  <p>Flat head screws Ø3*17mm</p>	<p>O x 1 pc</p>  <p>Allen wrench M4</p>
<p>P 2 sets Anti-tipping kit</p>      <p>Wall straps 2pcs</p> <p>screws Ø4*35mm 2pcs</p> <p>screws Ø3.5*15mm 2pcs</p> <p>wall anchors Ø8*30mm 2pcs</p> <p>washers Ø14mm 4pcs</p>		
<p>Not included</p> 	<p>Not included</p> 	<p>Not included</p> 



1

- D  x6
- C  x6
- O  x1

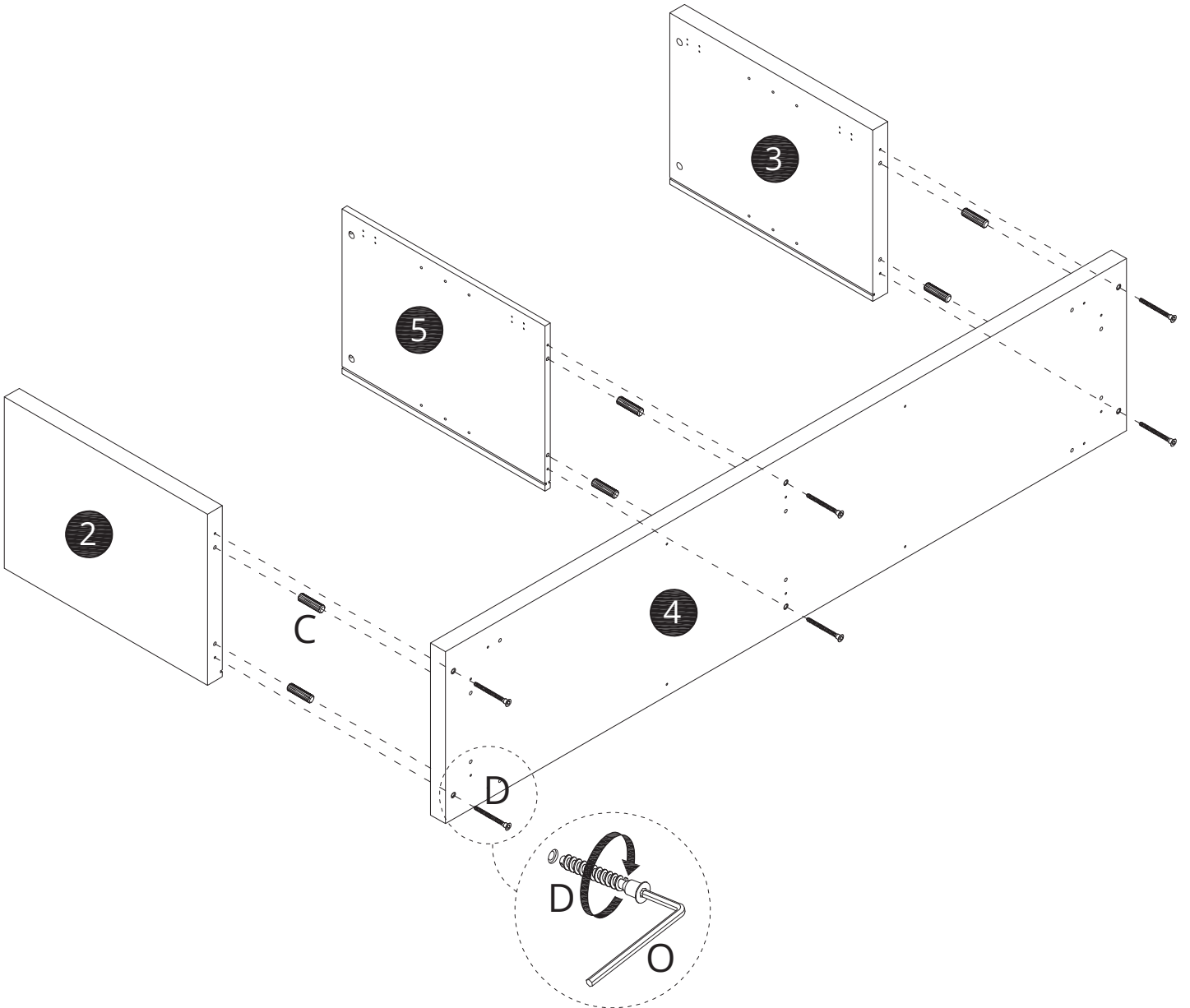
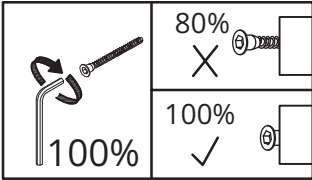

2

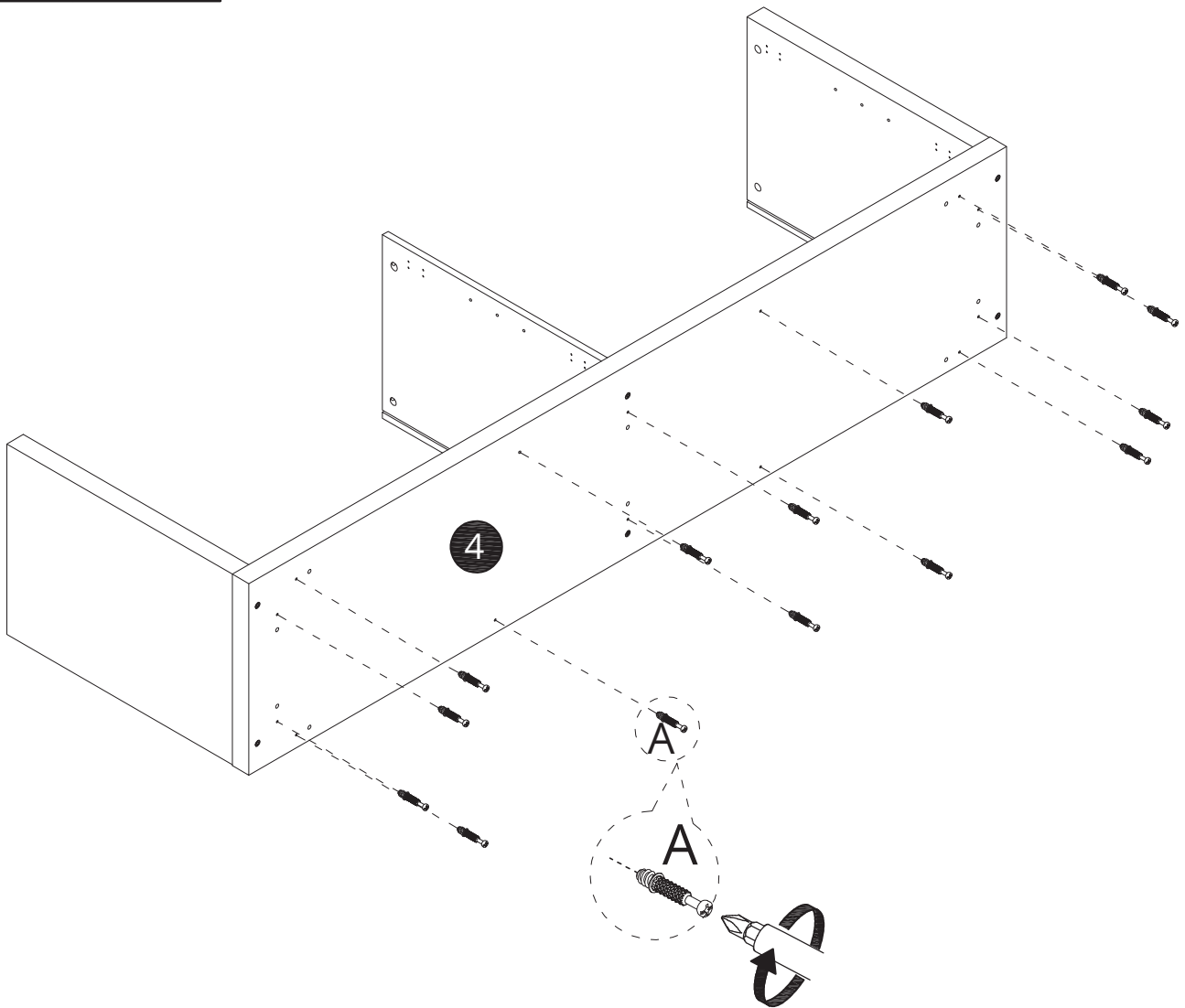
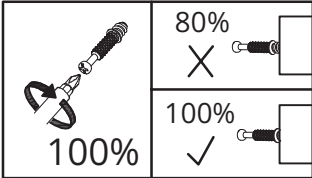
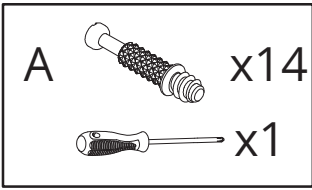

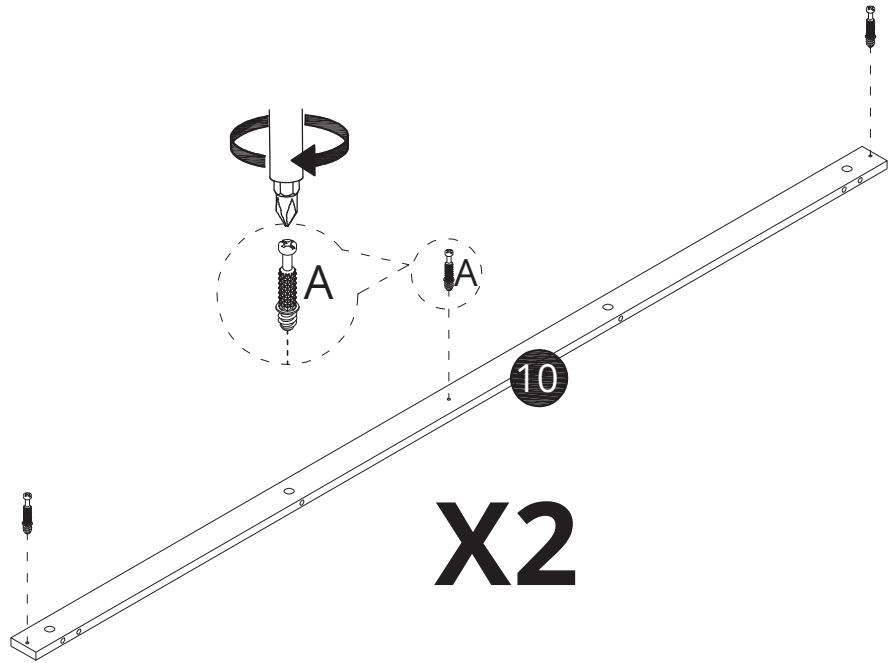
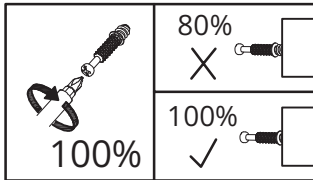
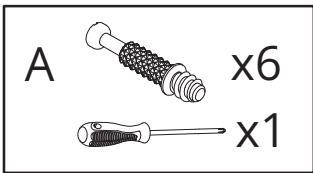

3

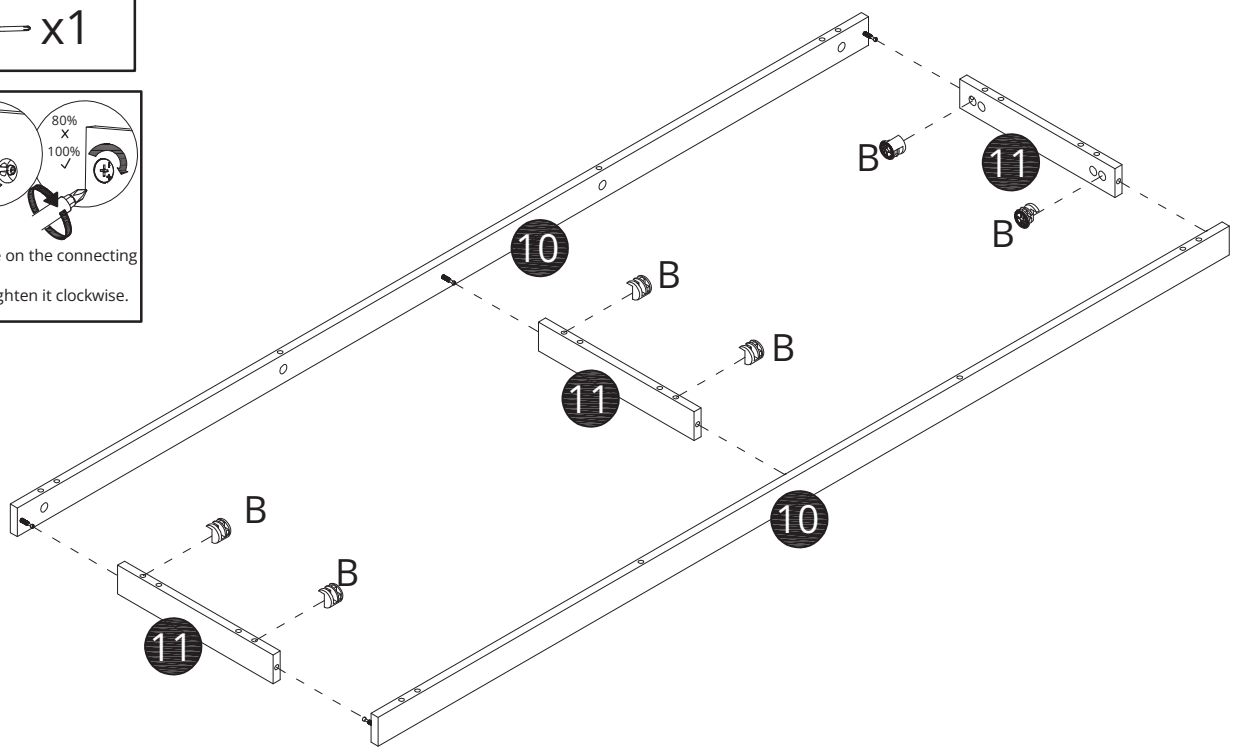
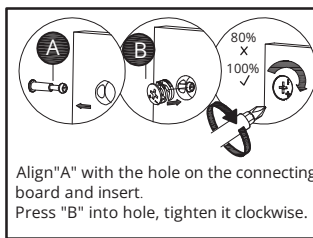
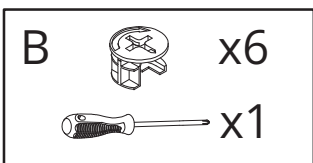

4



5

B		x14
C		x10
		x1

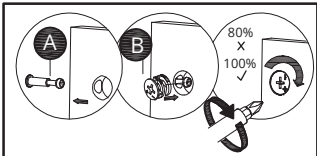

Align "A" with the hole on the connecting board and insert.
Press "B" into hole, tighten it clockwise.

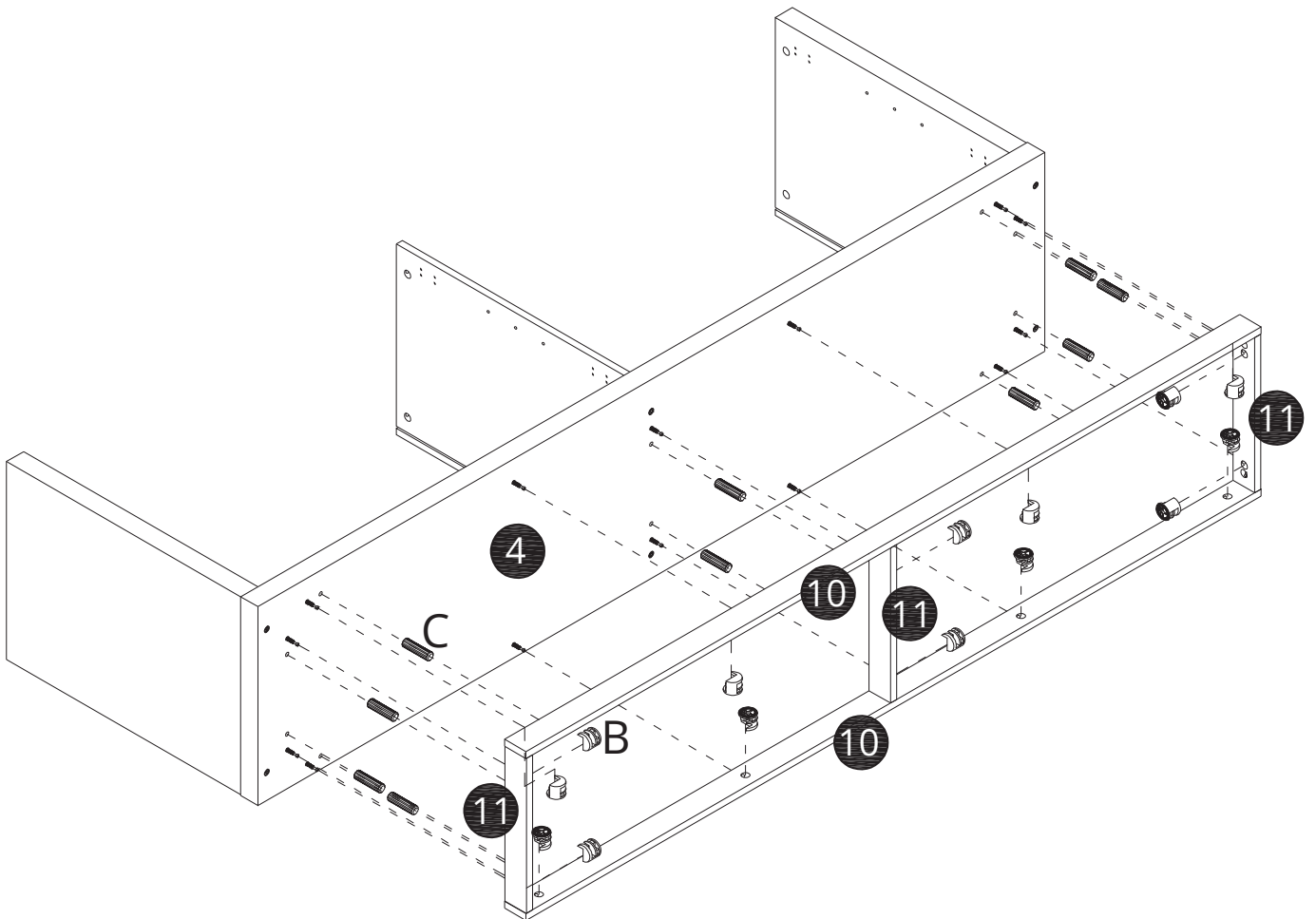



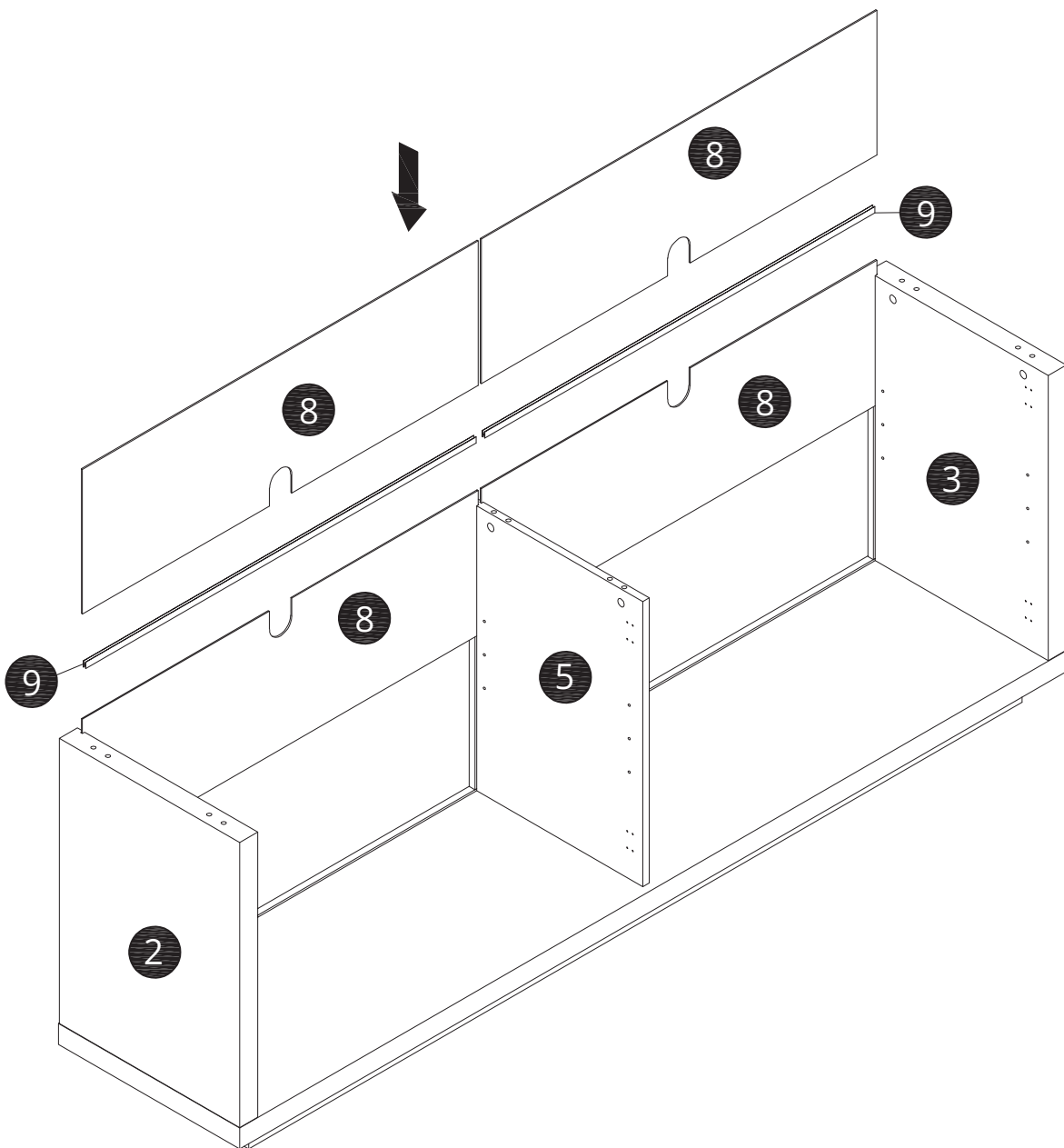

6

Firstly, slide down 2pcs back panel ⑧ into the groove, then put down part ⑨ into the edge of ⑧, finally, slide down the rest 2pcs part ⑧ into the groove.



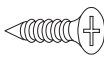

7

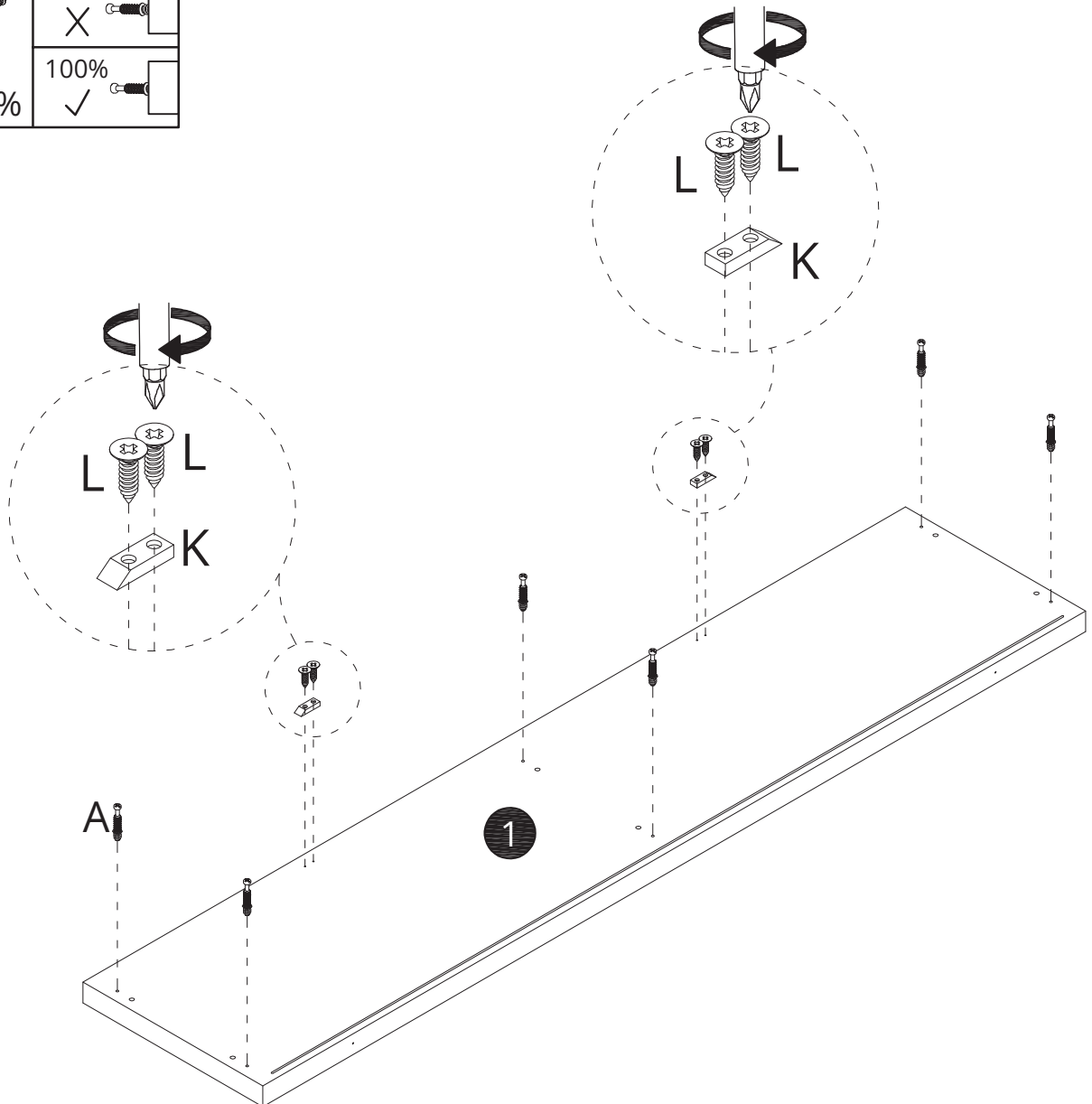
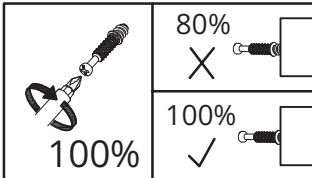
- A  x6
- K  x2
- L  x4
-  x1



8

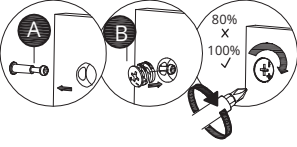

- B  x6
- C  x6
-  x1

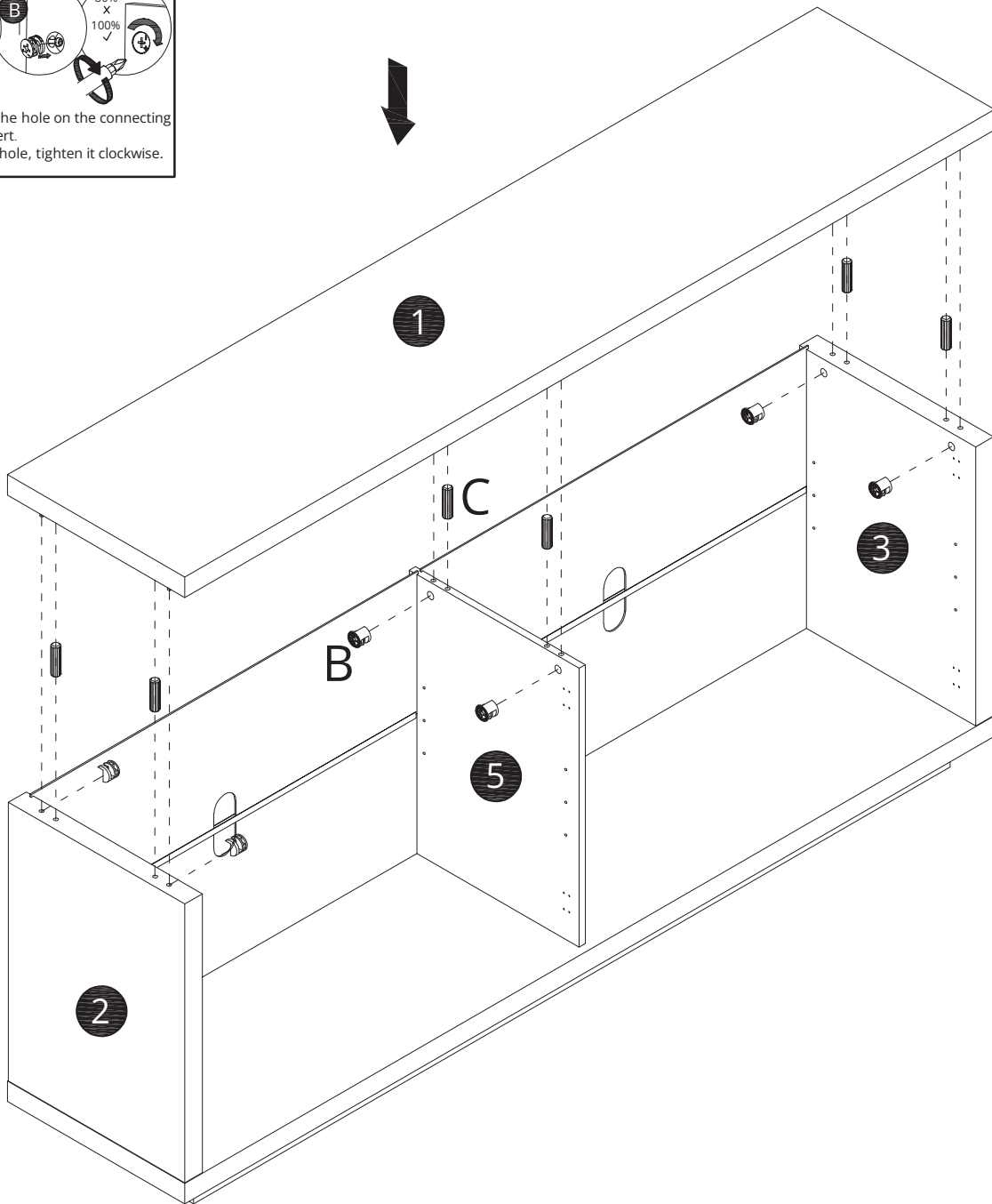

Align "A" with the hole on the connecting board and insert.
Press "B" into hole, tighten it clockwise.



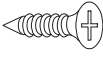



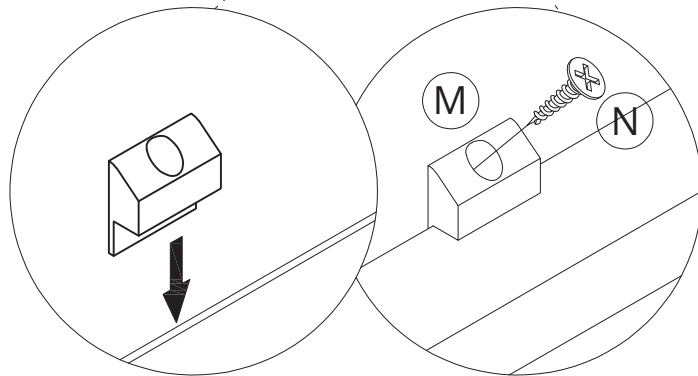
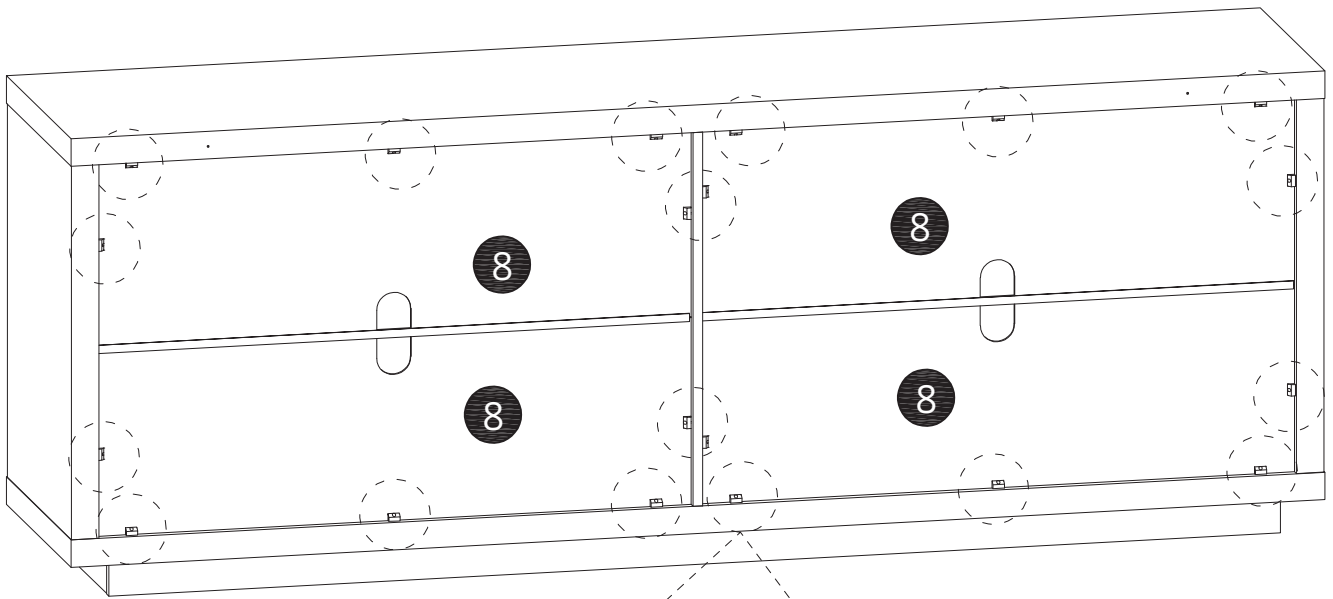
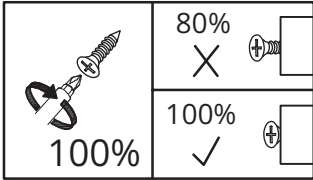

9

- M  x20
- N  x20
-  x1



10

- F  x4
- G  x4
- H  x16
-  x1

	80% X	
	100% ✓	

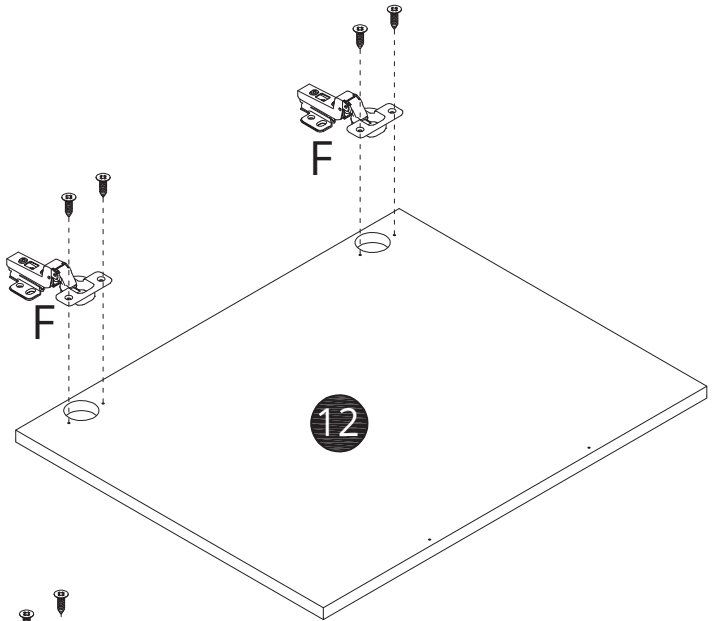



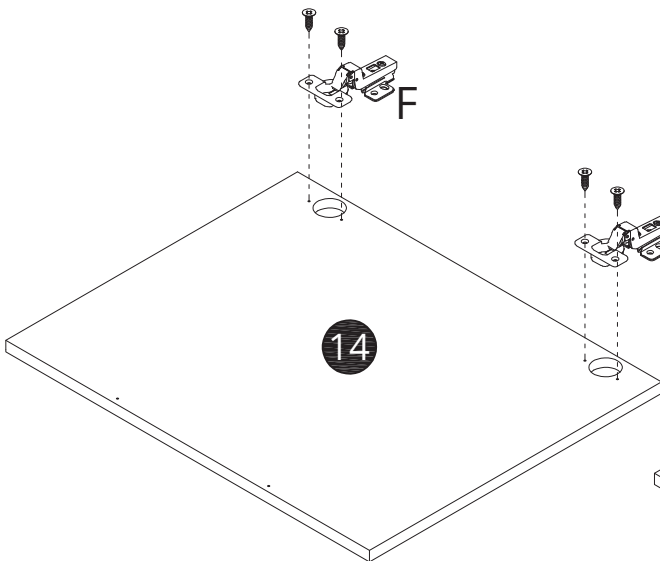
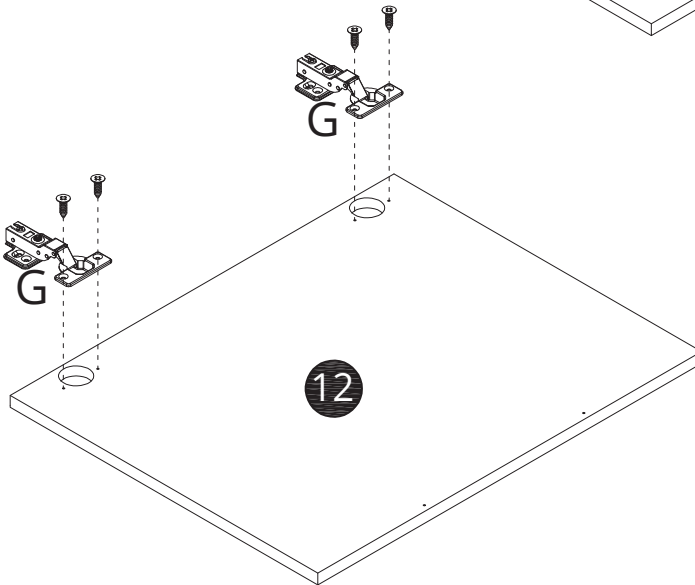

Moderate curved door hinge
(Half cover) Ø35mm

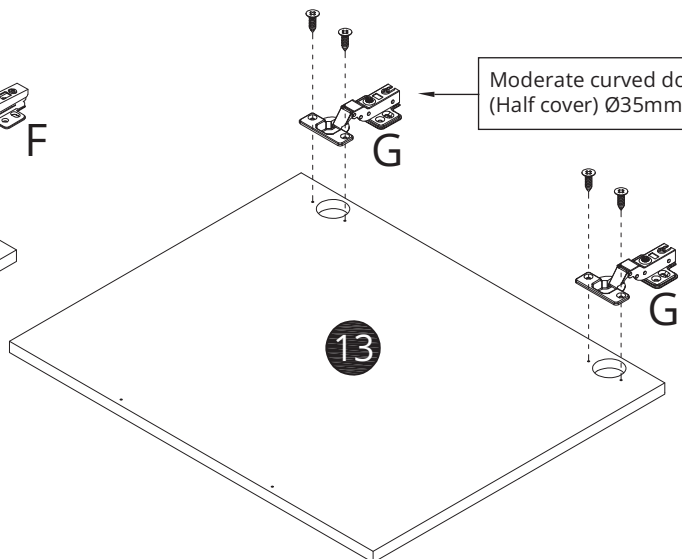



Moderate curved door hinge
(Half cover) Ø35mm



11

- I  x2
- J  x4
- H  x16
-  x1

	80% X 
	100% ✓ 

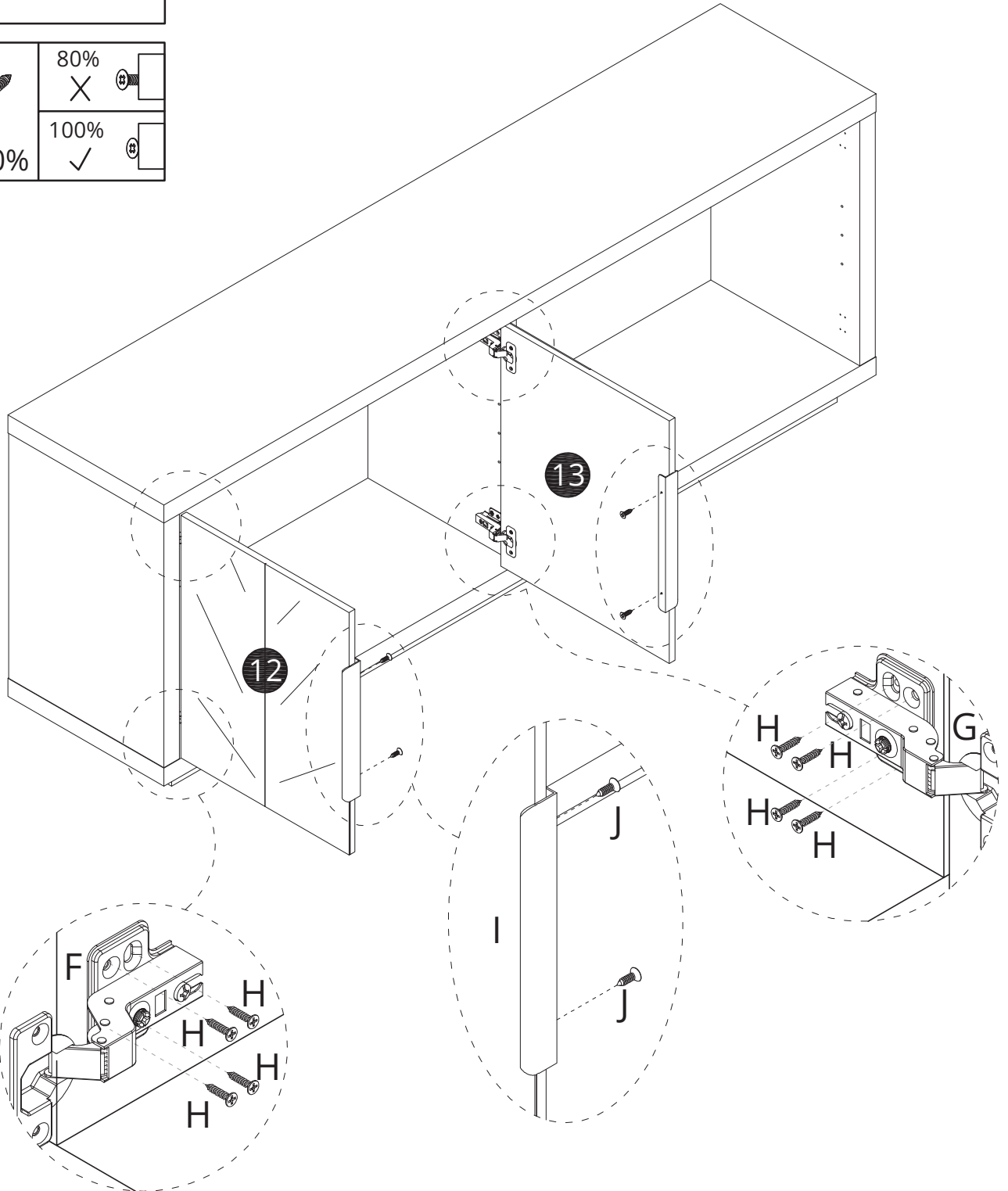

12

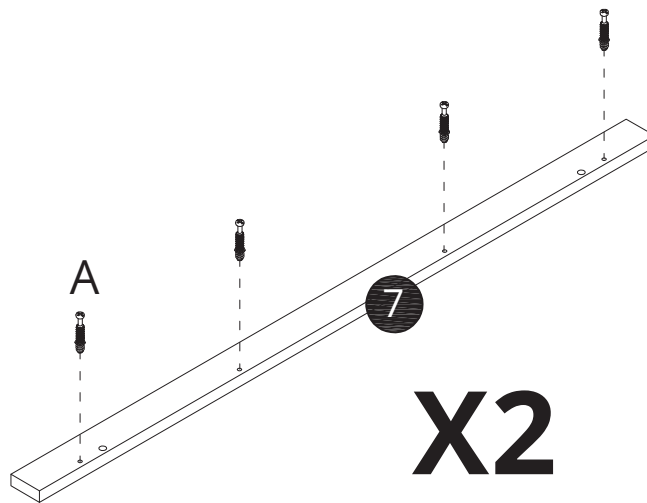
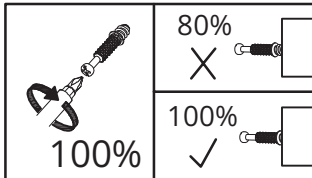
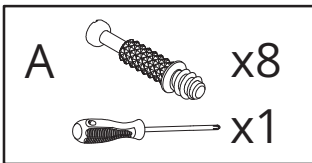

13

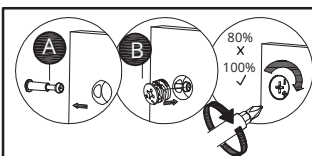
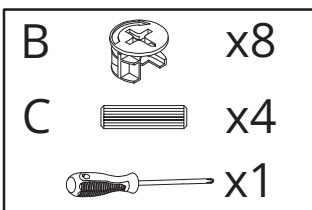

Align "A" with the hole on the connecting board and insert.
Press "B" into hole, tighten it clockwise.

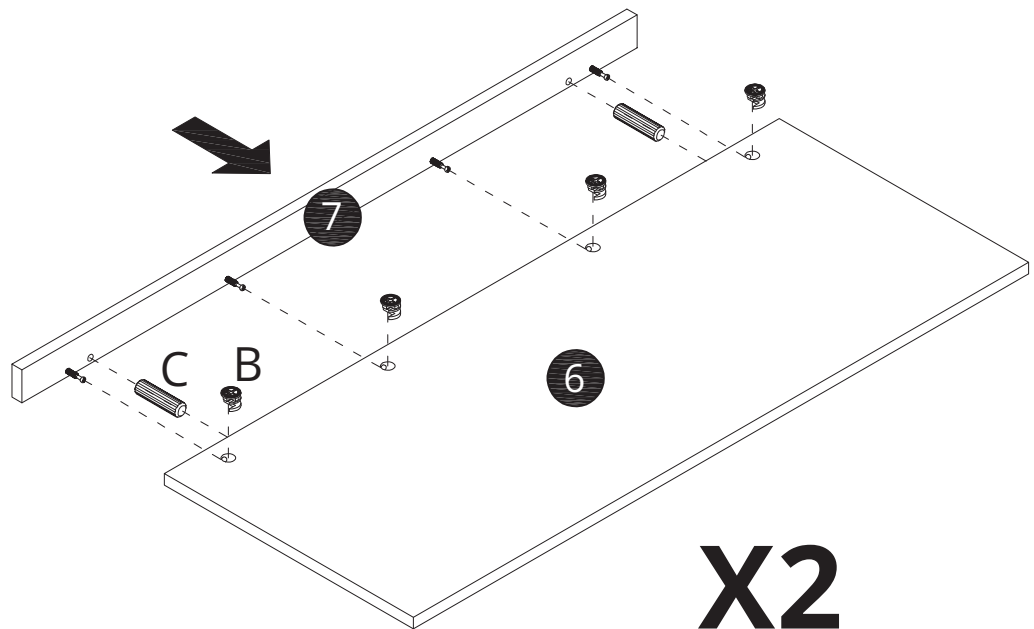



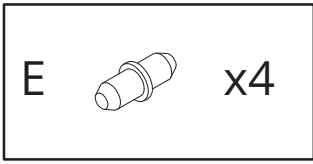

14

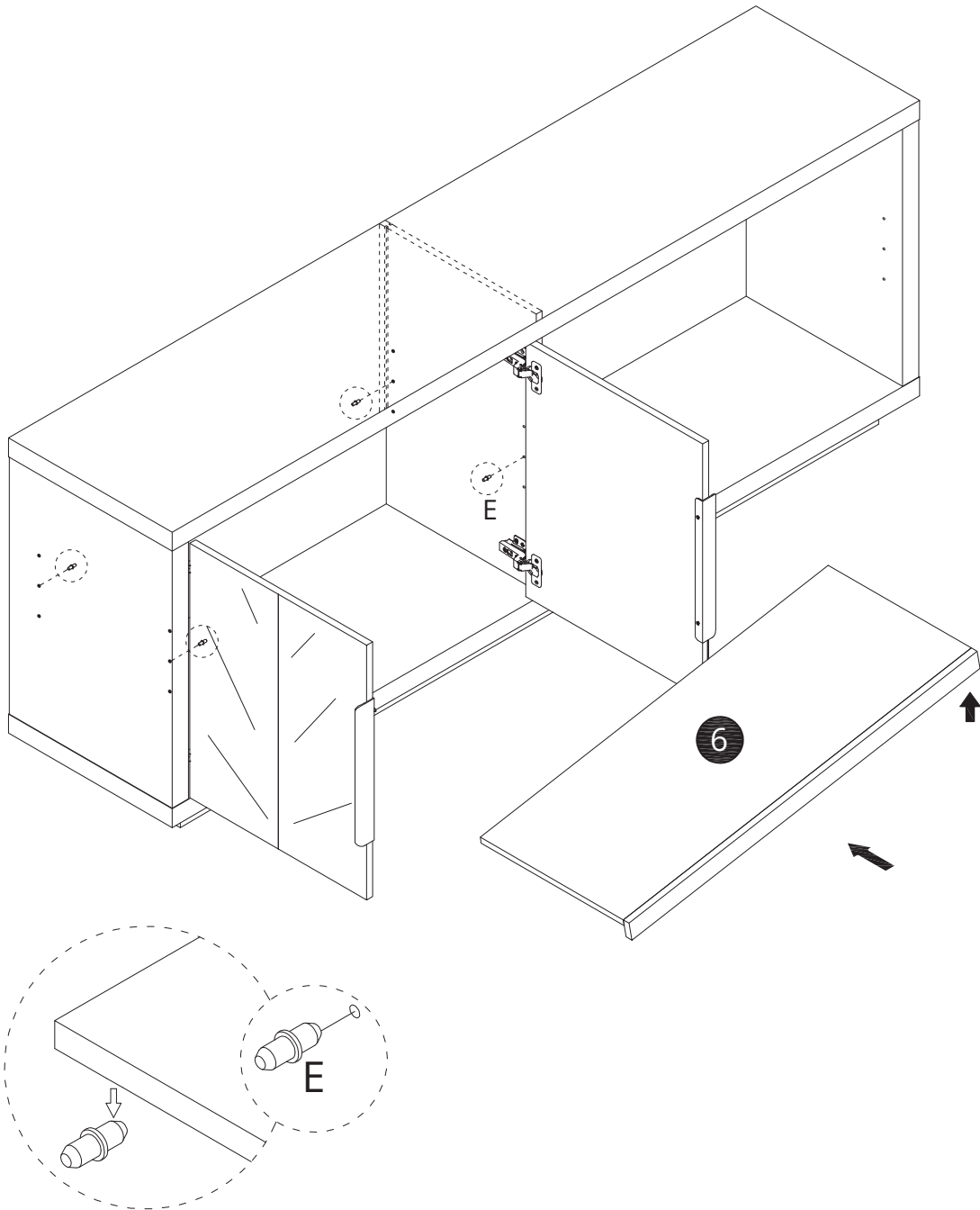



Insert the shelf pin E into the holes at your desired height, then place shelf panel onto the pins, aligning them with the supports.



15

I		x2
J		x4
H		x16
		x1

	80%	
	X	
100%	✓	

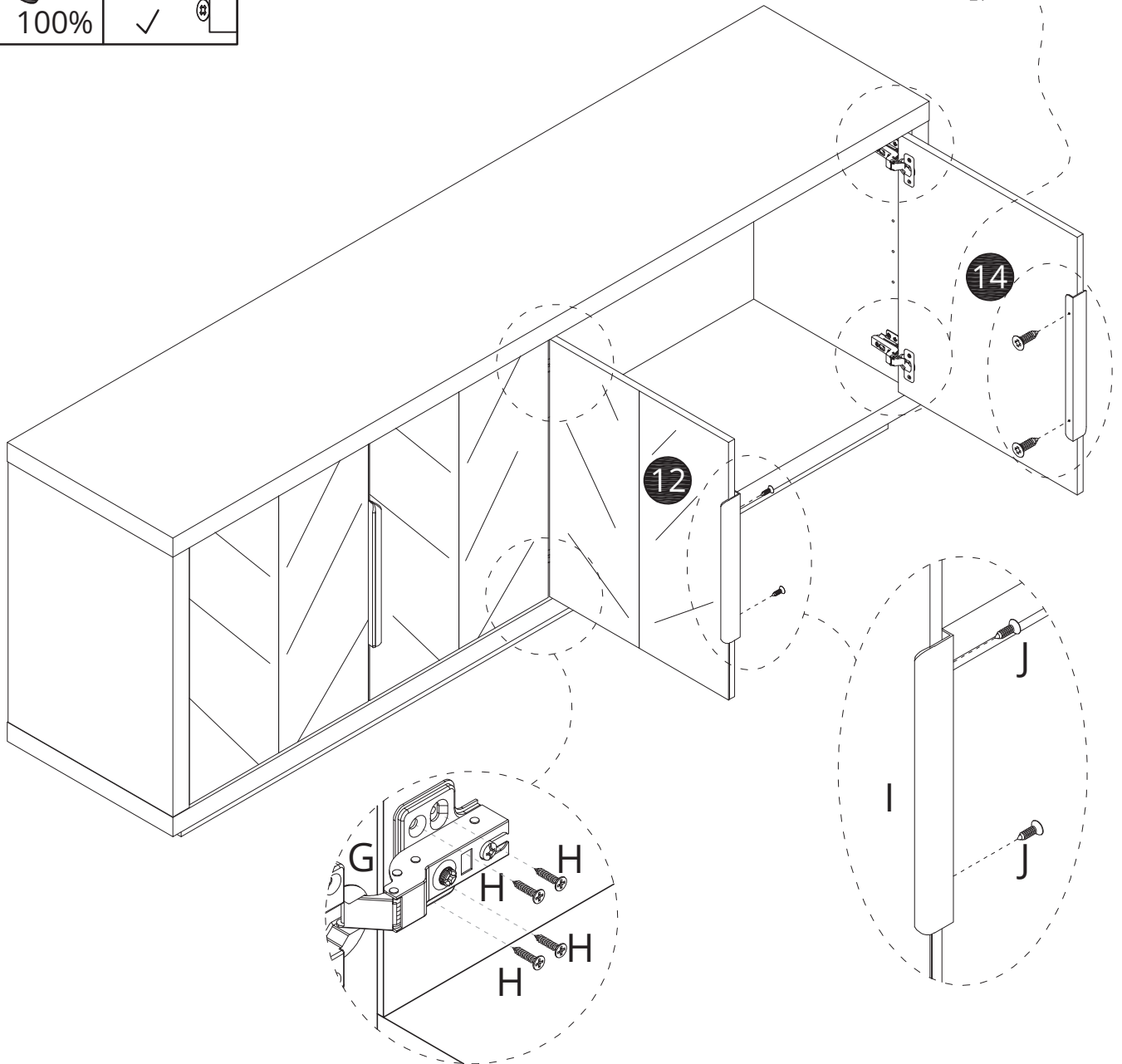
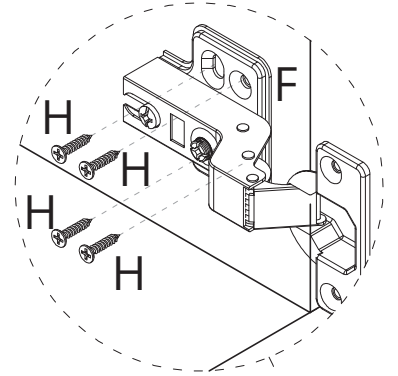

16

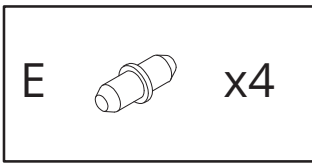



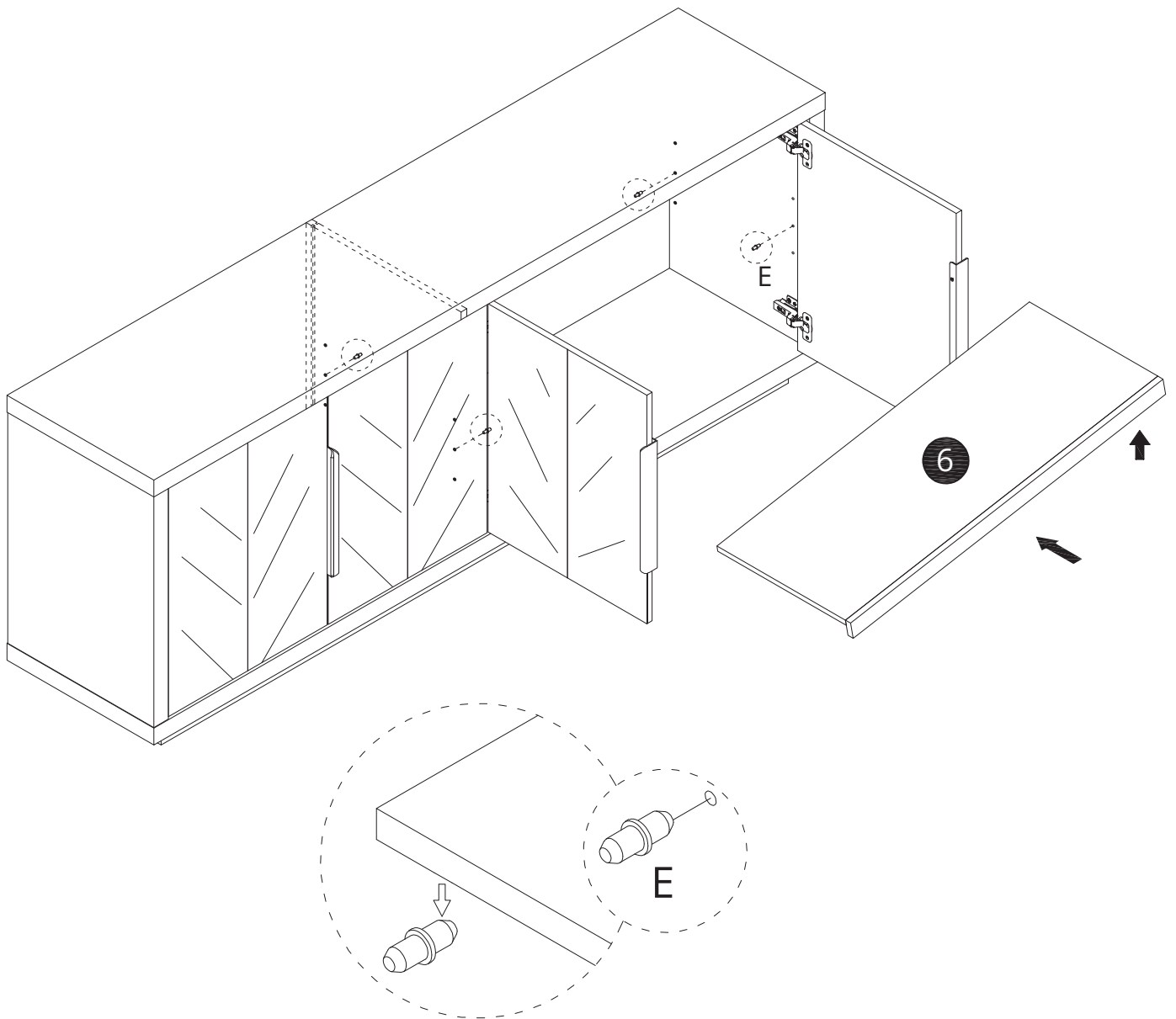

Insert the shelf pin E into the holes at your desired height, then place shelf panel onto the pins, aligning them with the supports.

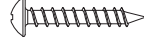

17

Anti-tipping-kit

P		x2		x2		x2
		x4		x2		

For safety reasons, please be sure to attach the product to the wall to avoid accidents!
Please follow below:

1. Drill two holes with a diameter of 1/4 inch using an electric drill.
2. Hammer the wall anchor into the wall
3. Fasten anti-tip strap with round-head screw provided

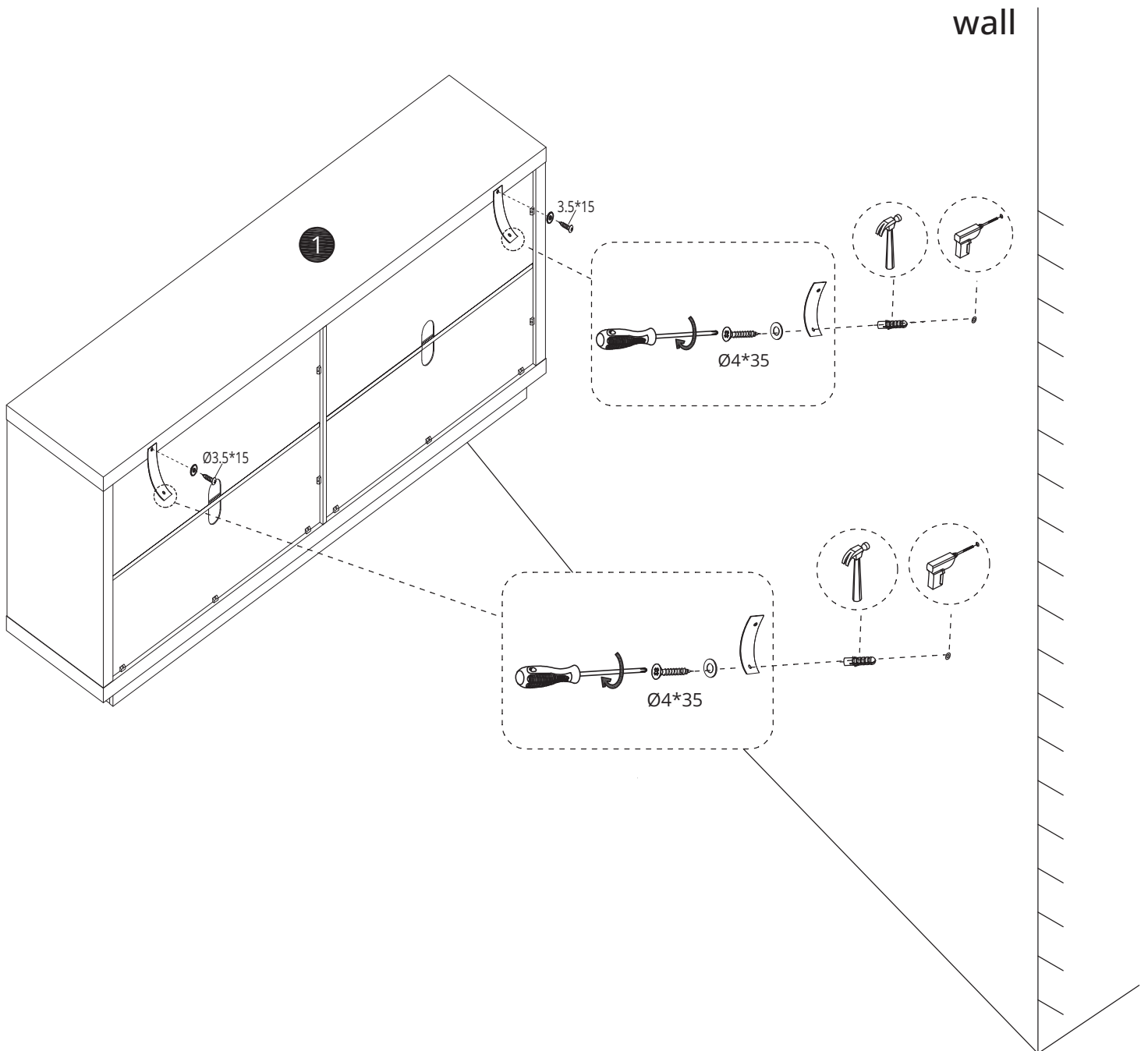

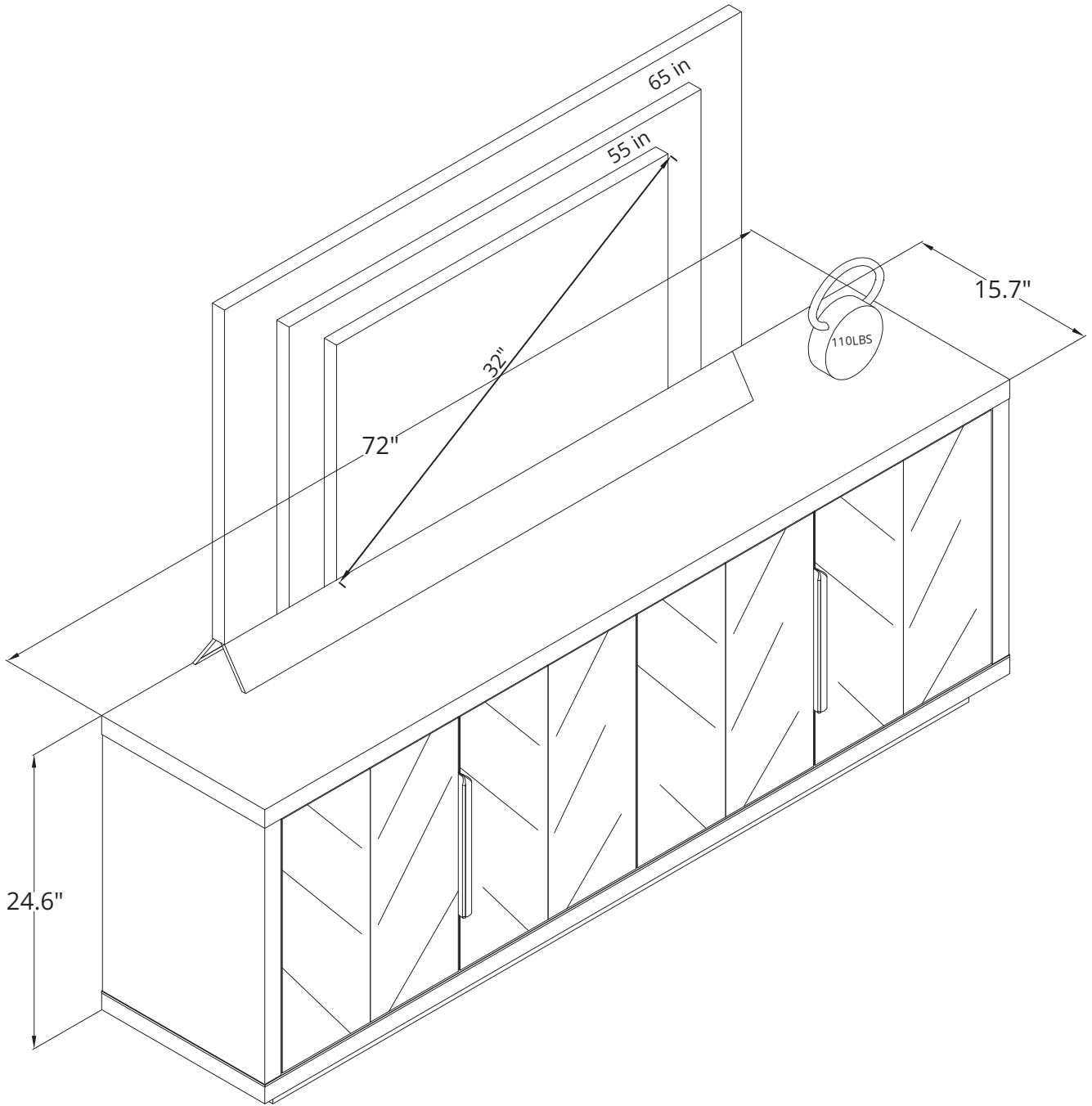

FINISHED

