

ASSEMBLY INSTRUCTIONS

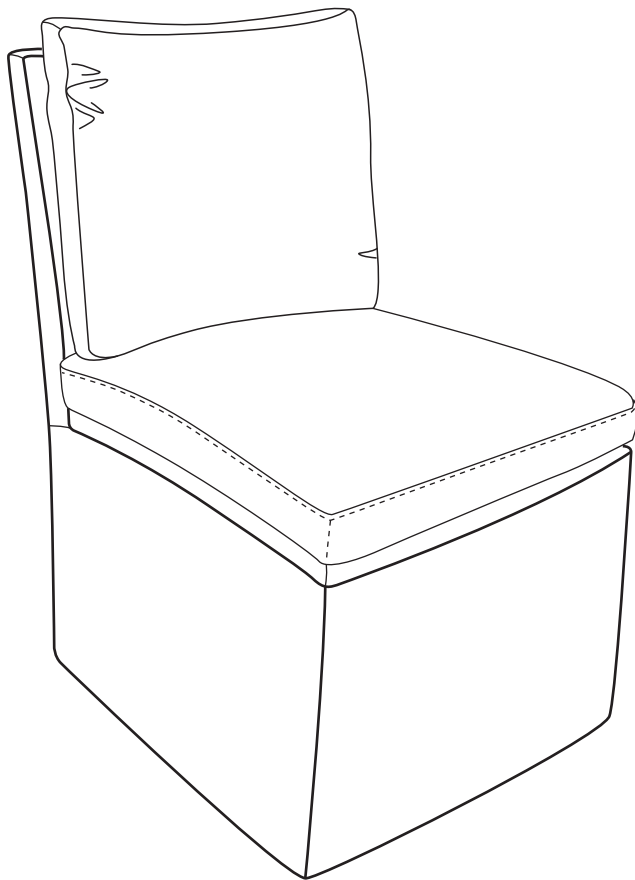

THIS INSTRUCTION BOOKLET CONTAINS IMPORTANT INFORMATION.
PLEASE READ AND KEEP IT FOR FUTURE REFERENCE.

THANK YOU FOR PURCHASING OUR PRODUCTS!

This furniture is designed for indoor application. Please read this booklet carefully and use all the items correctly as described. And please kindly note that the warranty does not apply to any product that has been improperly used.

After unboxing and before assembly, please check whether there are any parts damaged. If yes, please contact our customer service team by calling the numbers below. Meanwhile, please check whether you have all the parts and hardware listed. If there is any missing item, also please contact us immediately.

Before Assembly

- Remove all wrapping materials, staples and packing straps.
- Read the Parts List and Hardware List carefully, make sure all parts and hardware are intact.
- Place all parts on a clean and smooth surface, such as a rug or carpet, to prevent the parts from being scratched.
- Do not cross-thread screws.
- Do not use electric tools.



Make sure all bolts and screws are fully tightened before using chair.

Components



A: 1 PC

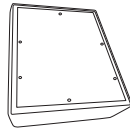

B: 1 PC



C: 4 PCS



M6×40 mm

1: 6 PCS



8×22×1.5 mm

2: 10 PCS



M6

3: 1 PC



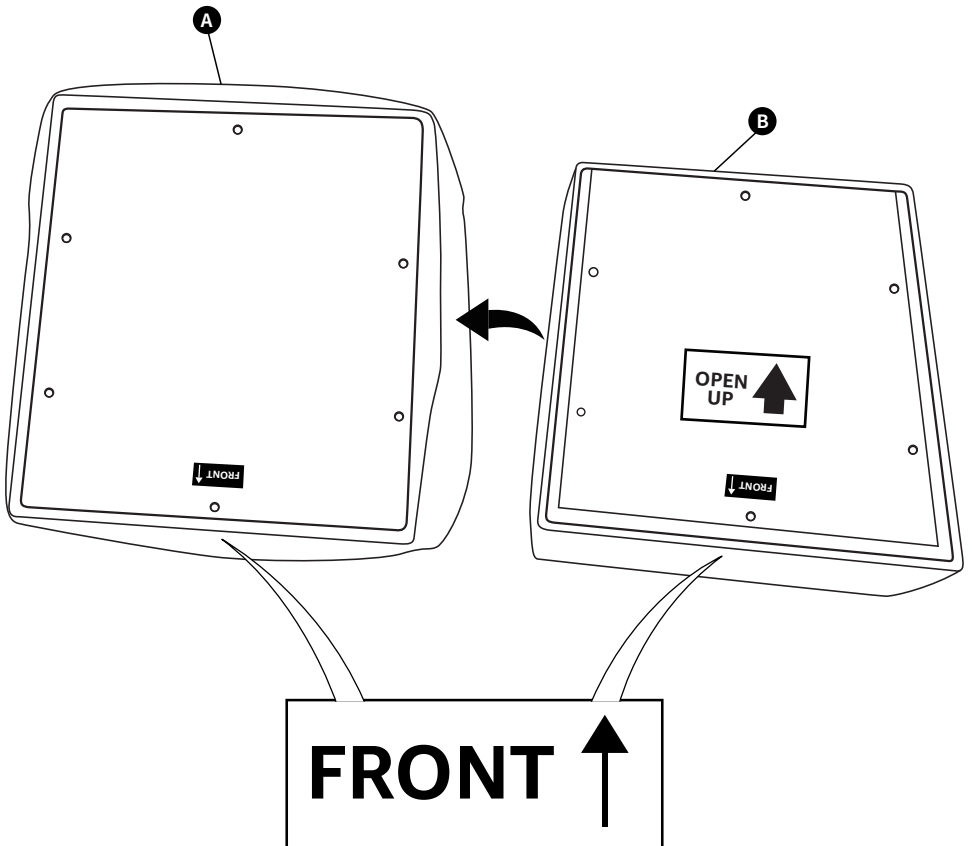

4: 1 PC

1

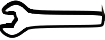

2

- 1**  M6×40 mm (**6 PCS**)
- 2**  8×22×1.5 mm (**10 PCS**)
- 3**  M6 (**1 PC**)
- 4**  (**1 PC**)

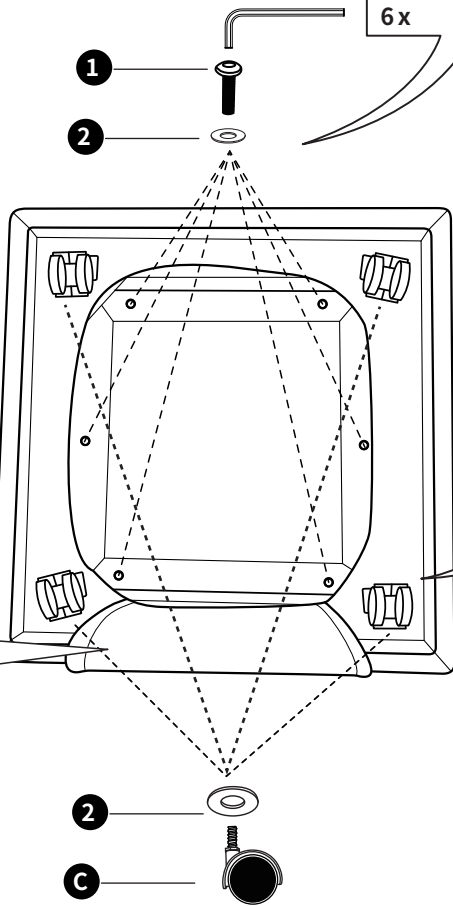
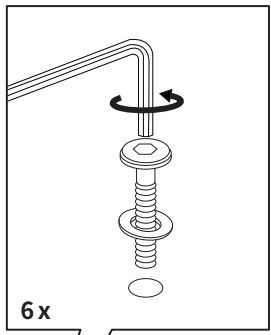

Unzip and align the upper front label with the lower front label for installation.

Insert the casters into the designated holes and tighten them securely clockwise using a wrench until they can't be turned anymore.

3

After assembly, zip up the lower part of chair.

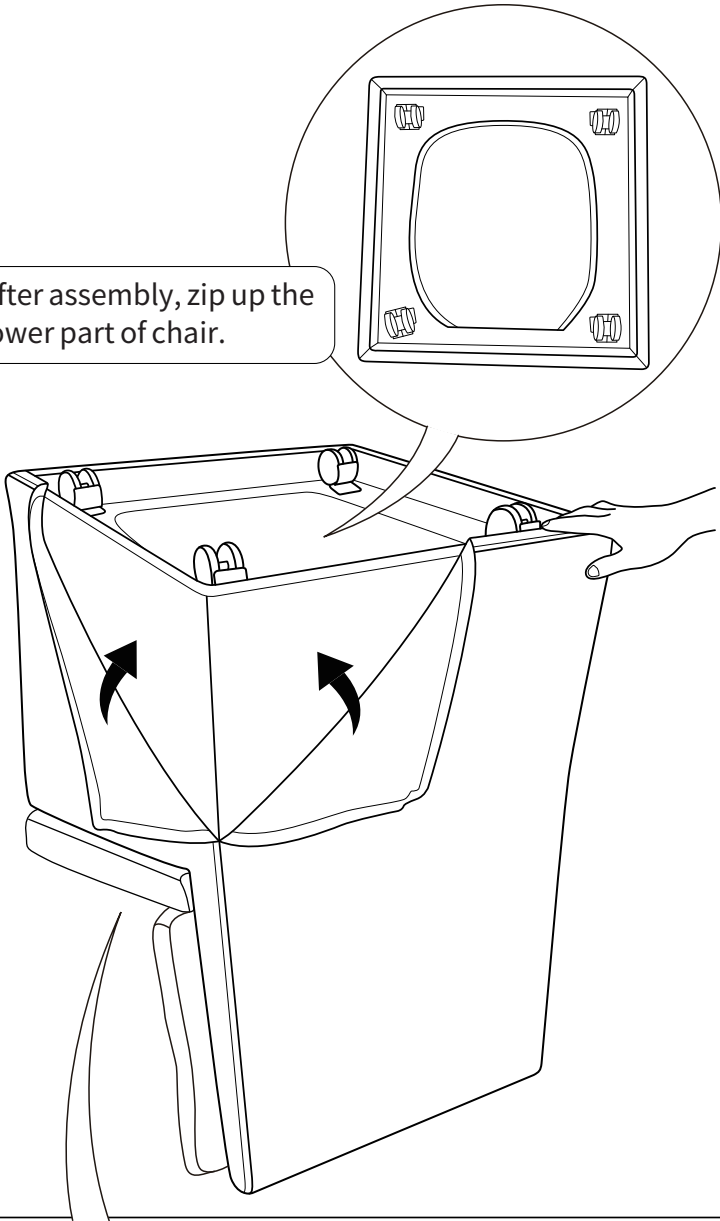

Pull the fabric on the upper part of chair straight and keep its edges flat before sticking it to the bottom of the lower part.



Safety and Care Advice

Warnings

- Use on level surface only.
- Do not stand on the chair or use it as a ladder.
- Only one person sitting on the chair at a time is permitted.
- Do not use the chair if parts are damaged or screws are loose or missing.
- Do not sit on the edge of the seat. Please always sit properly.
- Do not allow kids to play with the chair.
- Never leave children alone with the chair.
- Severe injuries will occur, if these warnings are ignored.

Cleaning & Maintenance

Cleaning:

- Wipe with a soft, slightly moist cloth.
- Never use corrosive detergents, wire brushes, abrasive scourers, metal or sharp tools to clean this chair.

Maintenance:

- Check and tighten all parts regularly.
- If this chair is damaged or seem unsafe, immediately contact us for after sales services.

Limited Warranty

We promises to repair or replace any product or component that is found to be defective in material or workmanship within one (1) year, from the date of original purchase as the original purchaser owns and uses the products. This warranty is subject to the provisions below.

Exclusions

This warranty does not apply and no other warranty applies to:

- Modifications or attachments to the product that are not approved by Duhome Inc.
- Products that were not installed, used, or maintained in accordance with product instructions and warnings.
- Warranty does not cover color, grain, or texture variations associated with natural wood and grain seen in any finish color.
- Damages caused by exceeding the prescribed weight limit.
- Material fading over time or through sunlight.
- Damages through spills or leaks.
- Collision damage (like rubbing against walls etc.).
- Accidental tears and damage.
- Cigarette or other burns.

To obtain service under this warranty

Please follow the steps below:

- Please kindly provide the order number and all the information of the product.
- If Duhome Inc. affirms that the product complies with the condition of warranty as stated, the customer representative will determine whether to provide replacement parts, replacement product, or repairs.