

CARNEGIE SINGLE / 2-LIGHT / 3-LIGHT WALL SCNCE / VANITY LIGHT

Model: LM030189 / LM030190 / LM030191

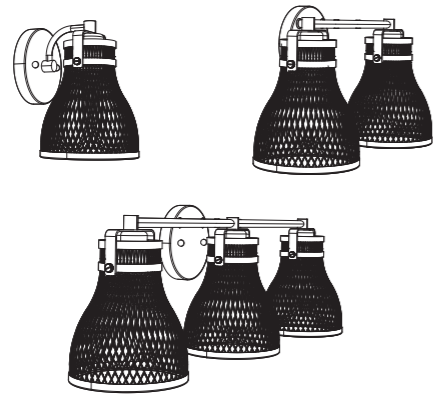

IMPORTANT INFORMATION.

PLEASE READ CAREFULLY AND RETAIN FOR FUTURE REFERENCE

THIS PRODUCT MUST BE INSTALLED IN ACCORDANCE WITH THE APPLICABLE INSTALLATION CODE BY A PERSON FAMILIAR WITH THE CONSTRUCTION AND OPERATION OF THE PRODUCT AND THE HAZARDS INVOLVED

INSTALLATION:

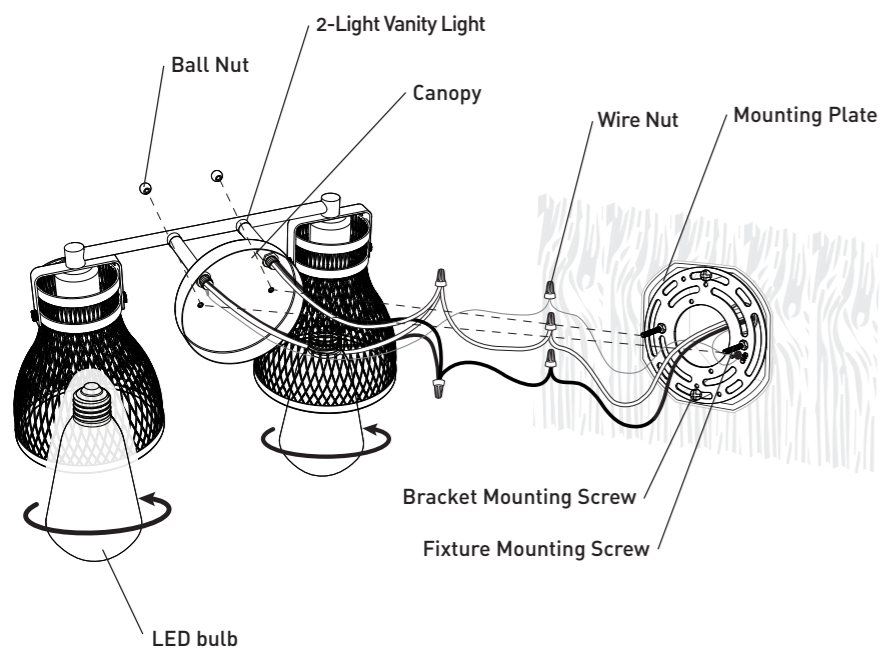

Important Safety Instructions:

Please read the following safety information before attempting to assemble, operate or install the product. To reduce risk of fire, electric shock, or injury to persons:

- CAUTION: Turn OFF the main power at the fuse or circuit breaker before installing the lighting fixture or making any electrical connection. You may use a non-contact voltage tester to ensure no power is running to the wires.
- CAUTION: Risk of fire. Min. 90°C supply conductors. Consult a qualified electrician to ensure correct branch circuit conductor.
- WARNING: If any special control devices are used with this fixture, follow instructions carefully to assure full compliance with N.E.C. requirements. If there are any questions, contact a qualified electrical contractor.
- Make sure this lighting fixture is adequately grounded. To ensure proper grounding, there must be a separate ground wire (bare copper) contact between this lighting fixture and the ground connection of your main power supply panel. Do not connect the bare or green insulation fixture ground wire to the black (hot) current-carrying wire or the white (neutral) wire. Connection of the bare or green fixture ground wire to the black or white wires may cause metal parts of the fixture to carry electrical currents, and may cause electrical shock, which could cause serious injury or death.
- Do not connect this fixture to an electrical system that does not provide a means for equipment grounding. Never use a fixture in a two-wire system that is not grounded. Installing a fixture into an electrical system not having a proper grounding could cause metal parts of the fixture to carry electrical currents if any of the fixture wires, wire connections, or splices were to become broken, cut, or loose during the mounting or normal operation of the fixture. Under this condition, anyone coming in contact with the fixture would be subject to electrical shock, which could cause serious injury or death.
- CAUTION: A loose wire increases the risk of fire; tighten all connections securely.
- Do not suspend any fixture by the house wires. Suspending a fixture by the house wires and wire connectors may result in the fixture falling, possibly causing personal injury and the danger of electrical shock or fire.
- The fixture must be installed by qualified electrician. All electrical connections must be in accordance with all national and local electrical codes
- CAUTION: All glass is fragile. Use care when handling glass shades and bulbs.

INSTALLATION PROCEDURE:

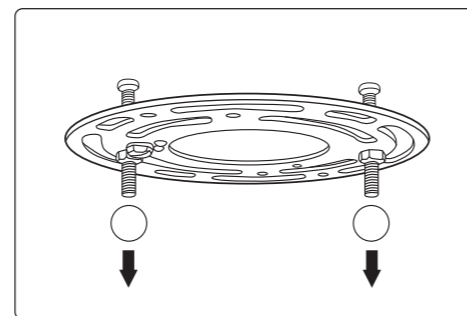

1. Loosen and remove the Ball Nuts from the Round Mounting Plate, set them aside.

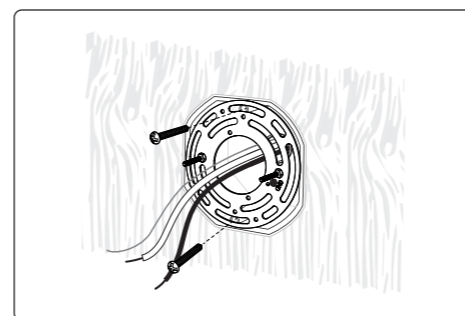

2. Pull the power supply wires out from the outlet box and install the Round Mounting Plate to the outlet box using the Bracket Mounting Screws included.

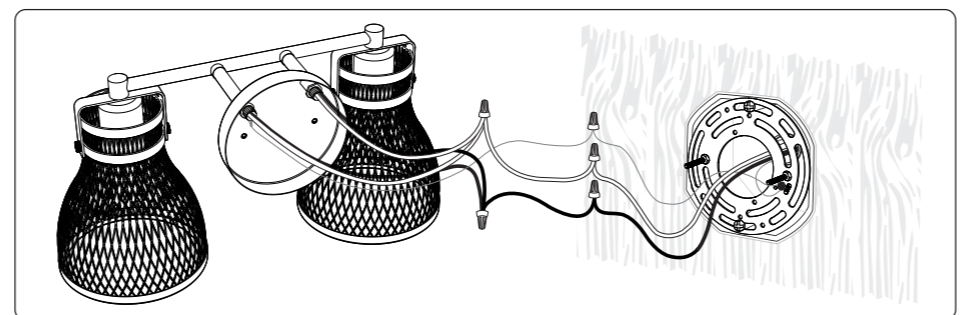

3. Make the following spliced wire connections using wire nuts: Black (hot) wire to the hot supply wire (most likely black or colored). White (neutral) wire to the neutral supply wire (most likely white). Bare copper (ground) wire to the supply ground wire (most likely bare copper, green wire, or green and yellow wire), or wrap around the ground screw if ground wire does not exist. Screw the wire nuts in a clockwise direction until tight. Make sure no bare wire or wire strands are visible after making the connections. Check for tightness by pulling wires.

PREPARATION

Carefully remove the lighting fixture, LED bulb and mounting accessories from the box, and check that all parts are included using the contents diagrams below. Do not attempt to assemble the product if any part(s) is missing or damaged. Please contact Koda customer support if this is the case.

PACKAGE CONTAINS:

Please lay out all parts and read the instructions prior to installation.

<p>Carnegie Single Wall Sconce Light (LM030189):</p> <p>1 x Wall Sconce Light</p>	<p>Carnegie 2-Light Vanity Light (LM030190):</p> <p>1 x 2-Light Vanity Light</p>	<p>Installation Kit:</p> <p>1 x Round Mounting Plate, 2 x Fixture Mounting Screws, 2 x Hex Nuts with 2 x Ball Nuts</p> <p>2 x Bracket Mounting Screws</p> <p>3 x Wire Nuts</p>	<p>LED Bulb:</p> <p>1 x LED Bulb (LM030189)</p> <p>2 x LED Bulbs (LM030190)</p> <p>3 x LED Bulbs (LM030191)</p>
--	---	---	--

Tools Needed (not included):

Philips and Flat Head Screwdrivers Wire Stripper Safety Glasses

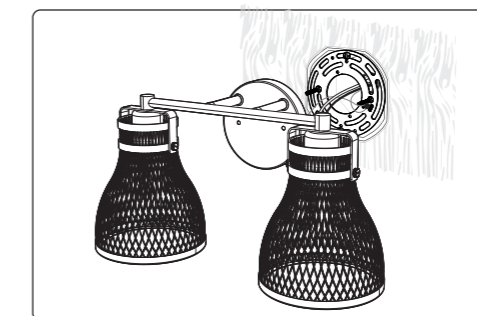

4. Attach the Canopy towards the outlet box and feed the Fixture Mounting Screws through the canopy openings. Adjust the Fixture Mounting Screws through the nuts until there is enough protrusion out from the Canopy.

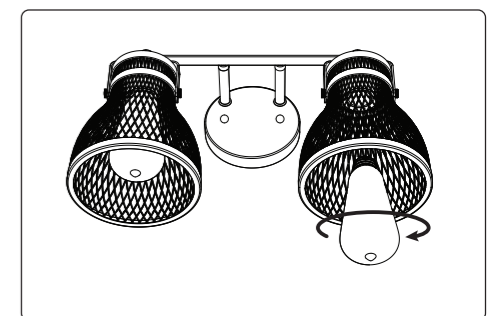

6. Insert the LED Bulb.

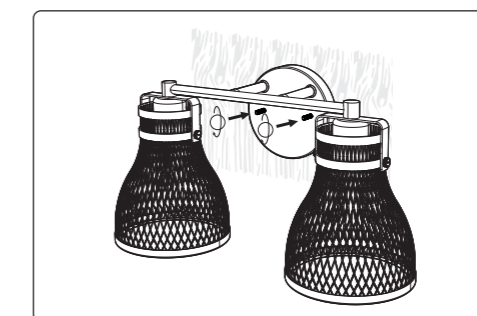

5. Insert the Ball Nuts towards thread of the Fixture Mounting Screws and tighten.

CARE AND MAINTENANCE:

Shut off main power supply before cleaning product or changing light bulbs. To clean, wipe with damp cloth. Do not use abrasive cleaners or cleaners that contain alcohol.

DIMMER SWITCH:

Most standard dimmers are compatible with this light. For a complete list of compatible dimmers, please visit www.kodabuilt.com.

PRODUCT SPECIFICATIONS:

Operating Voltage: 120 Vac, 60Hz
 Compatible with incandescent light bulb of 120V, 60W MAX, E26 base
 LED Bulb(s) (included): 600 lumen each, 2200K, 7W

DIMENSIONS:

LM030189

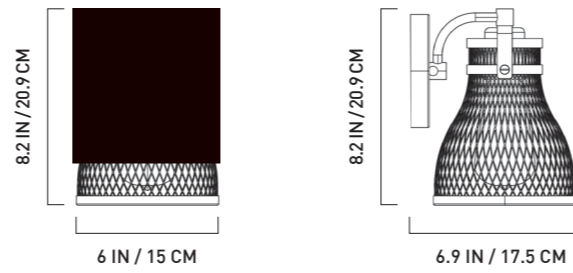

LM030190

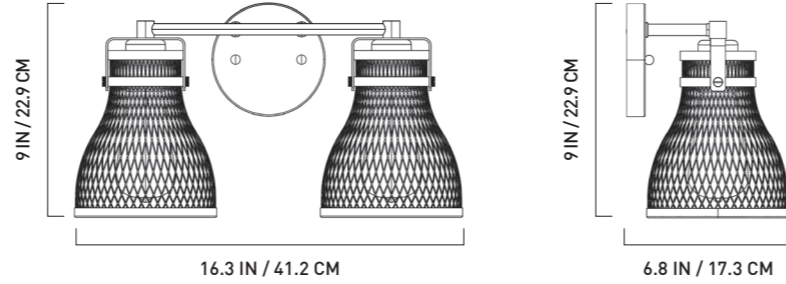

LM030191

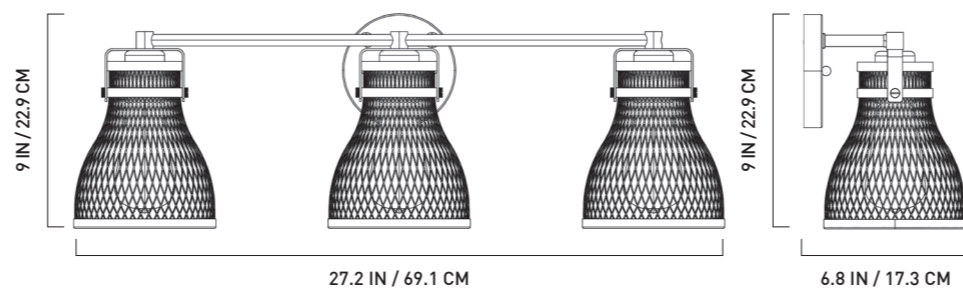

7

8

TROUBLESHOOTING:

Problem	Possible Cause	Solution
The light does not come on.	The light wall switch is turned off.	Turn the light wall switch on.
	The fuse is blown or the circuit breaker is turned off.	Replace the fuse or ensure the circuit breaker is turned on.
	Faulty wire connection.	Check all wiring to ensure they are correctly and securely wired.

9

Warranty:

This product carries a 5-year warranty against defects in workmanship and materials subject to the conditions and additional warranty information available.

DISCLAIMER OF WARRANTIES, INCLUDING WARRANTY OF MERCHANTABILITY AND WARRANTY OF FITNESS FOR PARTICULAR PURPOSE: EXCEPT AS SPECIFICALLY SET FORTH HEREIN, NO WARRANTY OR REPRESENTATION, EXPRESS OR IMPLIED, IS MADE AS TO THE KODA CARNEGIE VANITY LIGHT. KODA AND/OR ITS AFFILIATES EXPRESSLY DISCLAIMS, WITHOUT LIMITATION, ANY STATUTORY WARRANTIES AND ALL IMPLIED WARRANTIES, INCLUDING ANY IMPLIED WARRANTY OF MERCHANTABILITY OR FITNESS FOR A PARTICULAR PURPOSE.