

ASSEMBLY INSTRUCTIONS

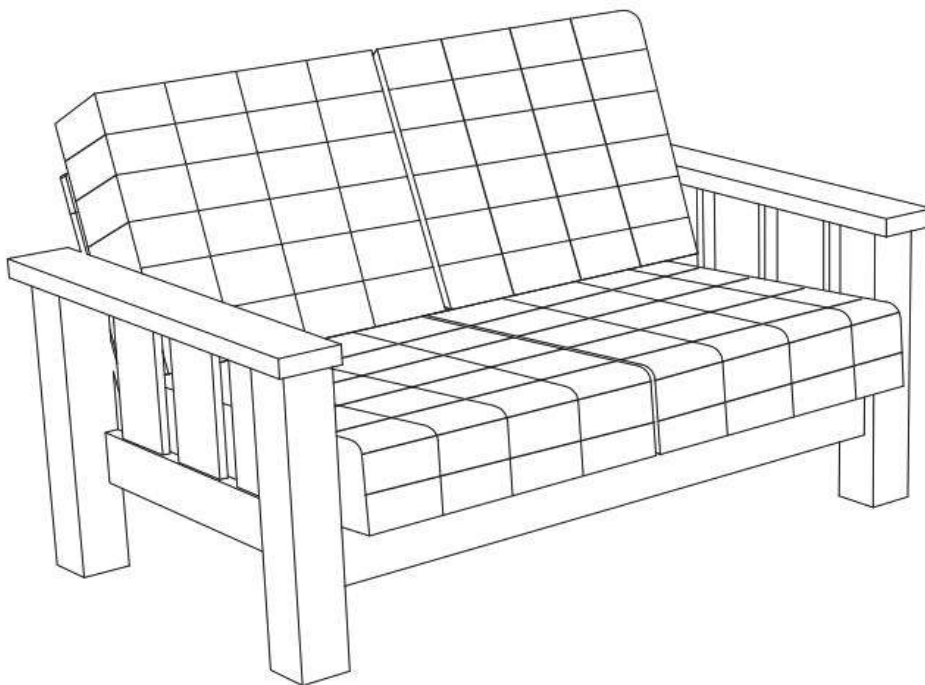

TOOLS REQUIRED



Screwdriver
(Not included)

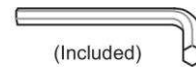

(Included)
Allen Wrench



2 - People

ASSEMBLY RATING



EASY —————> DIFFICULT

The Assembly Rating is a 5-point system showing the level of effort needed to assemble a specific product.



CHECK BEFORE STARTING

Are you missing anything?

Double-check all parts, hardware and accessories listed are all accounted for.

Check out our Quick Tips!

We recommend reviewing the pre-assembly handouts. Even experts need a refresher now and then!

Should we send any replacements?

Are there any irregularities or flaws in the parts? We can send replacements!

Prep Time!

Please review the assembly instructions and all diagrams prior to assembling.

PRE ASSEMBLY INTRODUCTION

We understand building ready-to-assemble furniture can be a challenging experience for some. To help avoid confusion, we have provided some helpful tips that may speed up the process.

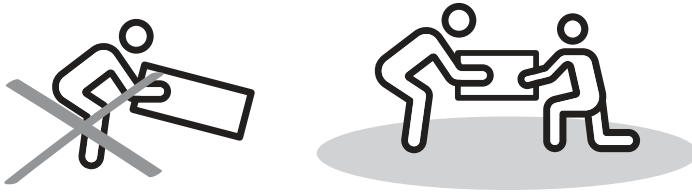

Teamwork

ALWAYS have at least two people to help with transporting and assembling the product to avoid potential injury and/or damage.

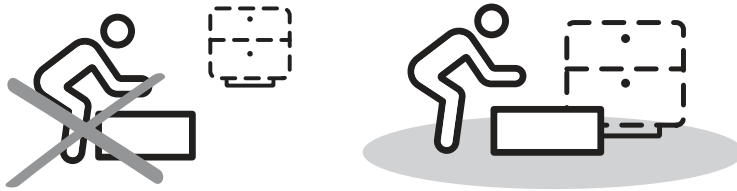

Suitable Location

Assembling near the area of the intended location is highly recommended.



Sufficient Space

Make sure you have enough space to move around during the assembly.

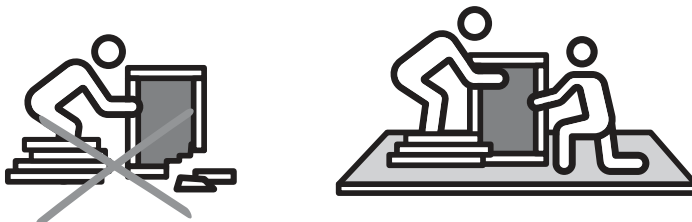

Avoid Scratches

Use cardboard, blankets or a carpeted area while assembling furniture to prevent scratches and damages.

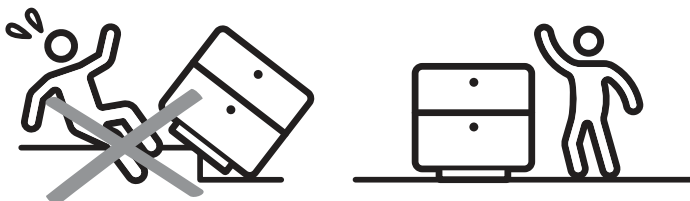

Flat Surface

Make sure the furniture rests on a flat and level surface with each leg evenly touching the floor.

ASSEMBLY AND CARE ADVICE



FAILURE TO FOLLOW THE GUIDELINES BELOW MAY RESULT IN INJURY AND/OR PROPERTY DAMAGE.



Position each part correctly and insert screws or bolts into their respective holes.

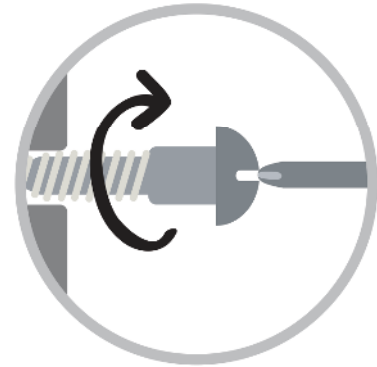

Turn clockwise to tighten and only tighten when step is completed or when instructed to do so.



Use the appropriate hand tools or power tools for assembly. Select steps, such as tightening screws and/or bolts, may require hand tools to avoid causing damage during assembly.



Save the instructions and store any supplied tools for later maintenance.

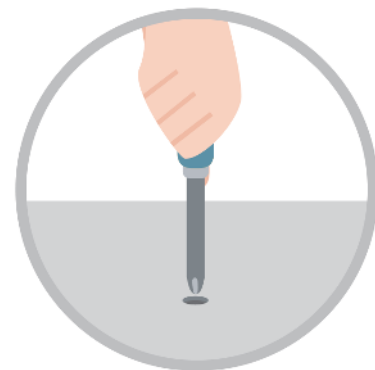

After two weeks, check and tighten any loose hardware and repeat again every six months thereafter.

IT IS THE USER'S RESPONSIBILITY TO MAINTAIN THE FURNITURE. THE HARDWARE MAY LOOSEN OVER TIME AND MAY CAUSE THE FURNITURE TO BE WOBBLY AND UNABLE TO SUPPORT ITS INTENDED WEIGHT CAPACITY. THIS MAY LEAD TO COLLAPSE AND MAY CAUSE SERIOUS INJURY.

LOVESEAT



- Please keep instructions for future reference.
- Check the quantity and irregularity of parts and hardware before you start.

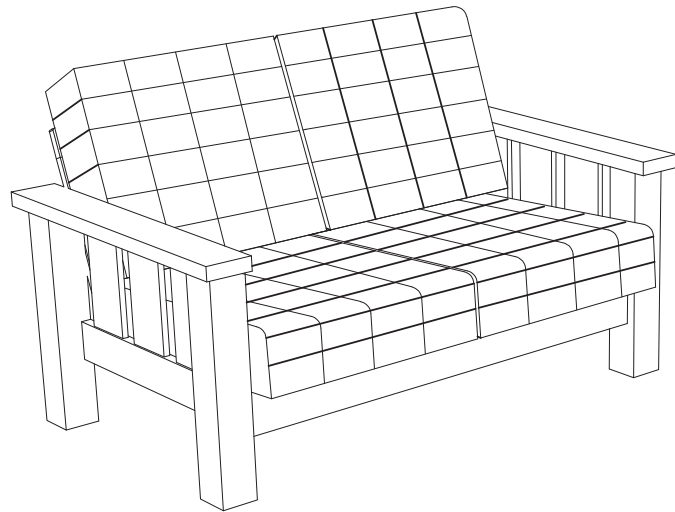

PARTS

#1 1pc

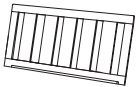

Back Rest

#2 1pc

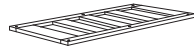

Seat Panel

#3 1pc

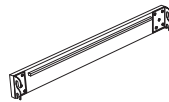

Front Rail Support

#4L 1pc

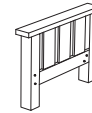

Arm Rest (Left)

#4R 1pc

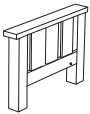

Arm Rest (Right)

#5 2pc

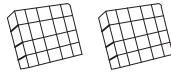

Back Cushion

#6 2pc

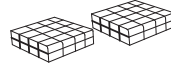

Seat Cushion

HARDWARE

#A 2pcs

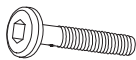

Bolt 1/4" x 2-3/8"

#B 2pcs

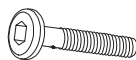

Bolt 1/4" x 3-9/16"

#C 4pcs



Lock Washer 1/4"

#D 4pcs



Flat Washer 1/4"xØ16

#E 2pcs



Barrel Nut 1/4"

#F 6pcs



Csk Screw M4x32mm

#G 4pcs



Wood Dowel 10x30mm

#H 1pc



Allen Wrench 4mm

#I 4pcs

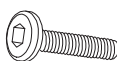

Bolt 5/16" x 1-3/8"

#J 4pcs

















Lock Washer 5/16"

#K 4pcs

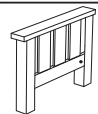
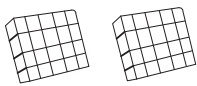

Flat Washer 5/16"xØ19

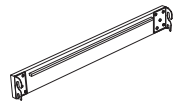
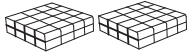
Carton	Disignton	Part	Hardware
	Arm Rest (Left)	#4L 	#A x 2pcs  #B x 2pcs  #C x 4pcs  #D x 4pcs  #E x 2pcs  #F x 6pcs  #G x 4pcs  #H x 1pc  #I x 4pcs  #J x 4pcs  #K x 4pcs 
	Arm Rest (Right)	#4R 	
	Back Cushion	#5 	
	Back Rest	#1 	
	Seat Panel	#2 	
	Front Rail Support	#3 	
	Seat Cushion	#6 	

ASSEMBLY INSTRUCTIONS

1

Insert dowels (#G) into the holes of the backrest (#1).

Part #1 x1pc
Hardware #G x4pcs

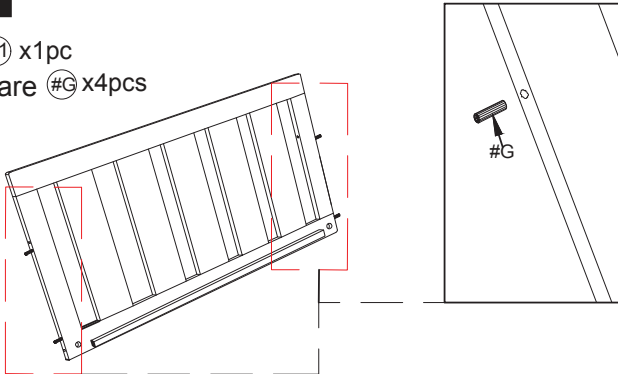

Align backrest (#1) to armrest (#4L, 4R). Insert bolts (#A) through washers (#C, D), through lowest armrest (#4L,4R) holes and lock with barrel nut (#E). Repeat with bolts (#B), insert through washers (#C, D) before inserting into highest armrest holes.

Note: Do not tighten until all bolts are locked.

2

Part #1 x1pc
Part #4L x1pc
Part #4R x1pc
Hardware #A x2pcs
Hardware #B x2pcs
Hardware #C x4pcs
Hardware #D x4pcs
Hardware #E x2pcs

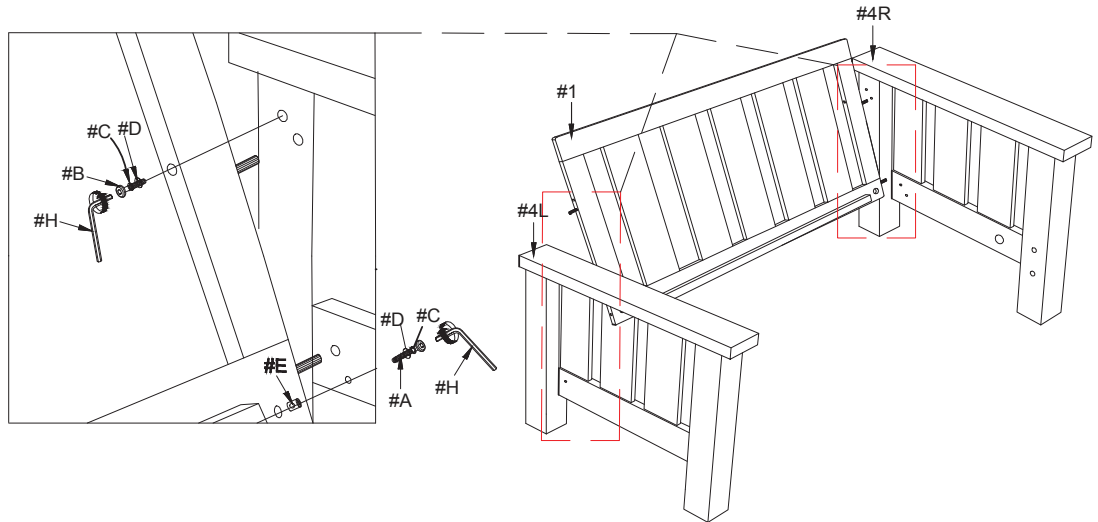

3

Part #3 x1pc
Hardware #I x4pcs
Hardware #J x4pcs
Hardware #K x4pcs

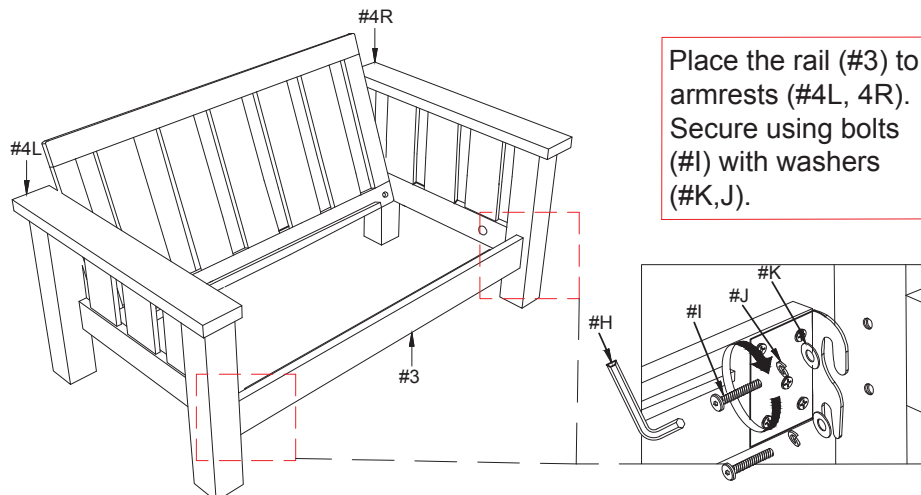

Place the rail (#3) to armrests (#4L, 4R). Secure using bolts (#I) with washers (#J) with washers (#K, J).

ASSEMBLY INSTRUCTIONS

4

Part #2 x1pc

Hardware #F x6pcs

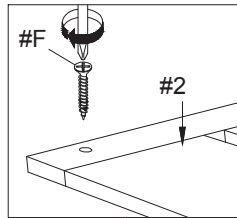

Align seat panel (#2) to frame and secure with screws (#F).

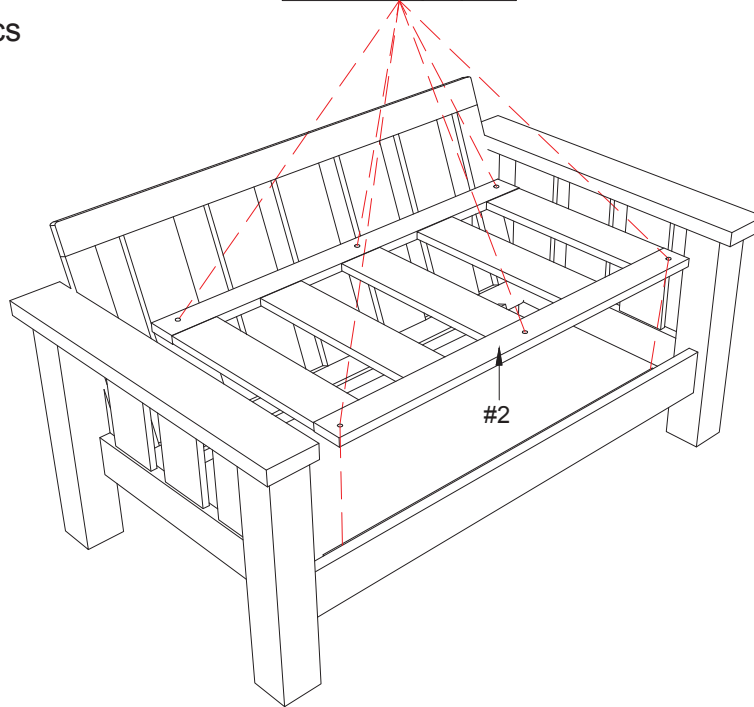

5

Part #5 x2pc

Part #6 x2pc

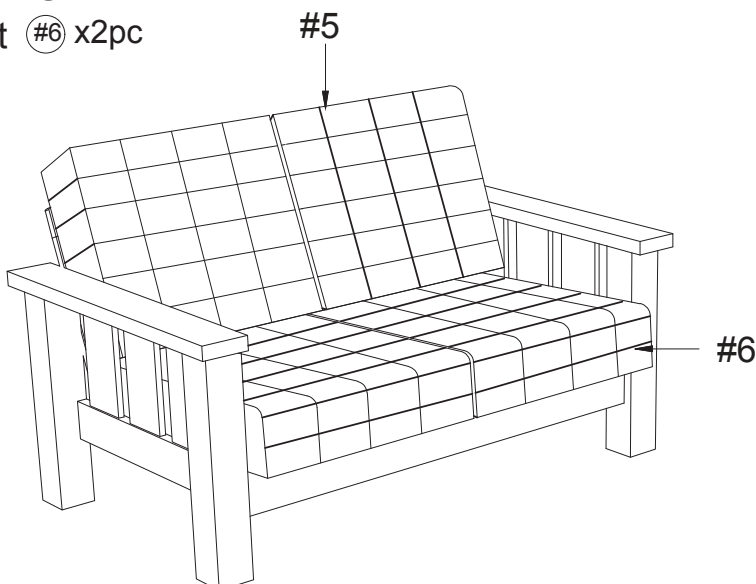

ASSEMBLY COMPLETED



Please ensure the furniture rests on an even and flat surface. If the product wobbles or feels loose, double-check all bolts and/or screws are properly tightened and secured.



Keep this handy!

Please retain this instruction manual and any order-related information for future reference.



Lift, don't drag!

To avoid damage to product please always LIFT the product when transporting or adjusting the placement.