

USER'S MANUAL

Product Name: **Outdoor Adirondack Chair Set**

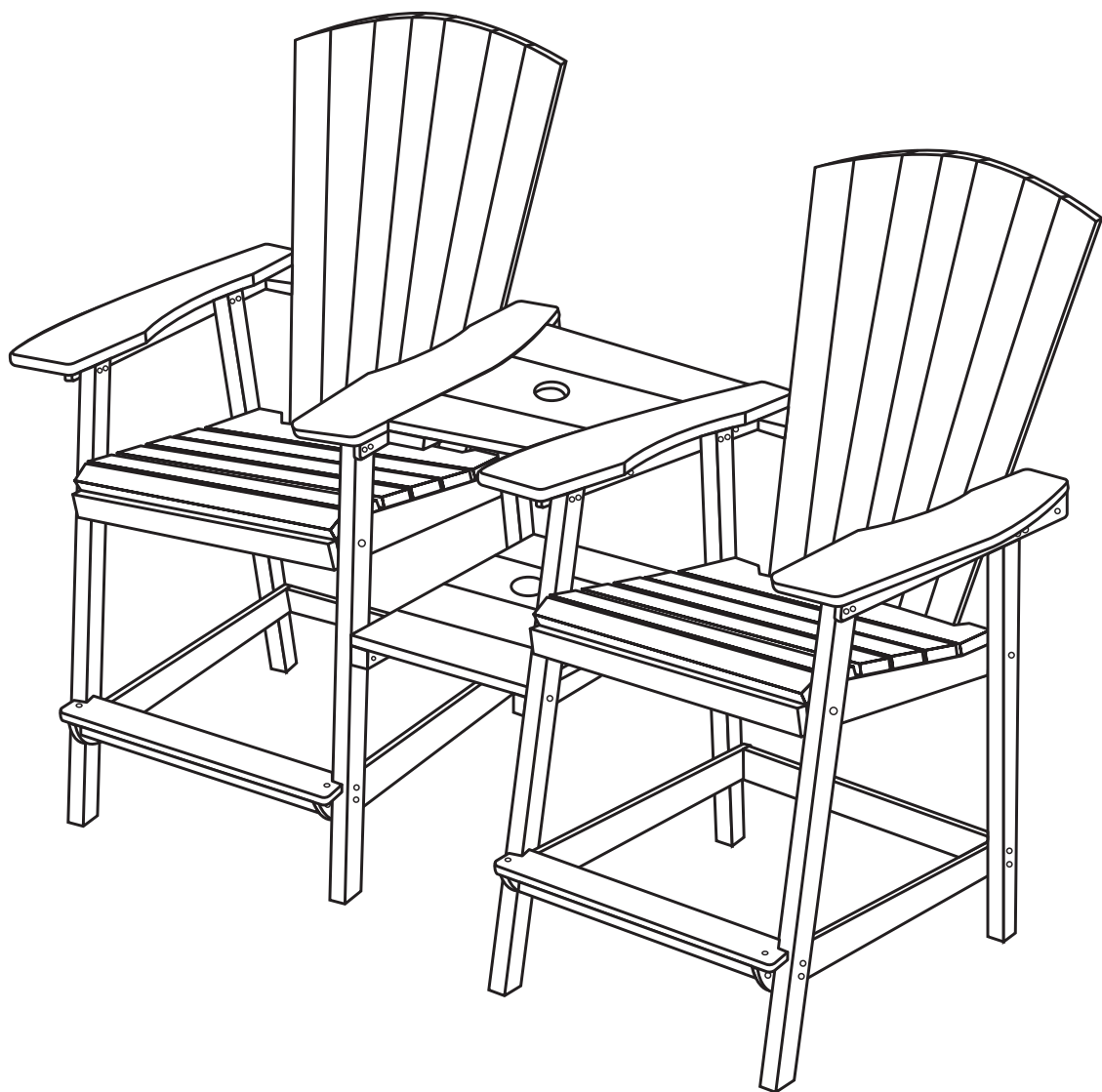

THIS INSTRUCTION BOOKLET CONTAINS
IMPORTANT SAFETY INFORMATION.
PLEASE READ AND KEEP FOR FUTURE REFERENCE.

Note: It is recommended that two people assemble this product together.



IMPORTANT NOTICE





Installation Precautions

- Check whether all the components in the package (panels,screws, hardware parts,etc.)are complete.Inventory them one by one according to the instruction manual list to avoid omissions.
- Carefully read the installation instruction manual of the furniture before installation to understand the structure and installation steps of the furniture. Pay attention to the warning information and special installation requirements in the instruction manual,and carry out the installation in the correct order.
- Wear gloves during the installation process to prevent your fingers from being scratched by burrs on the edges or screws and hardware parts.
- During the initial assembly,fix the screws loosely first.Do not fully tighten them until the item is completely assembled.
- After all the components are installed without any problems,be sure to fully tighten all the bolts,screws and knobs at last.
- It is recommended to reconfirm whethe rall the bolts,screws and knobs are firm every 90 days to ensure the stability of the product.
- After all the components are installed without any problems,be sure to fully tighten all the bolts,screws and knobs at last.
- There are many small metal parts in this product.There is a risk of suffocation if children accidentally swallow them.It is not suitable for children under 3 years old.
- Finally and most importantly,keep it away from fire sources and other heat sources.

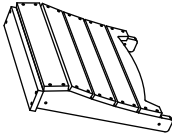
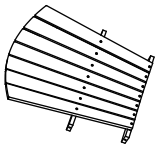
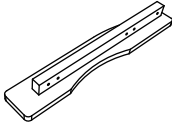
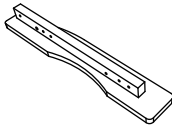
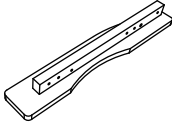
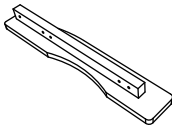

Adirondack Chair Cleaning Guide

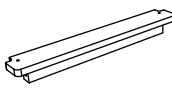
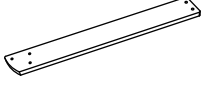
- 1.Use a dry vacuum cleaner to quickly remove loose dirt and debris.
- 2.Mix dishwashing liquid and warm water in a bucket.
- 3.To clean and disinfect,pour in a small amount of bleach.We recommend mixing 1 part of bleach with 2 parts of water.
- 4.Apply the soapy water to the wood with a towel and let it sit for a few minutes.
- 5.Scrub the surface with a soft-bristled brush to remove any dirt or debris.
- 6.Rinse with clean water and let the furniture air dry.

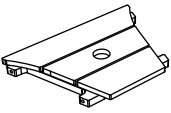
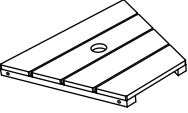

PARTS LIST

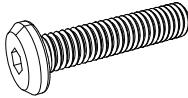
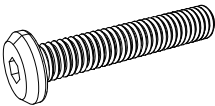
1 × 2pc	2 × 2pc	3 × 1pc	4 × 1pc	5 × 1pc
				
seat	Backrest	Left handrail	Right handrail	Left handrail
6 × 1pc	7 × 4pc	8 × 4pc	9 × 2pc	10 × 4pc
				
Right handrail	middle leg	outer leg	Front leg	Vertical Connector
11 × 2pc	12 × 1pc	13 × 1pc		
				
Horizontal Connector	Upper platform	Lower platform		

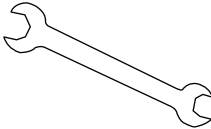
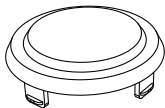
HARDWARE LIST



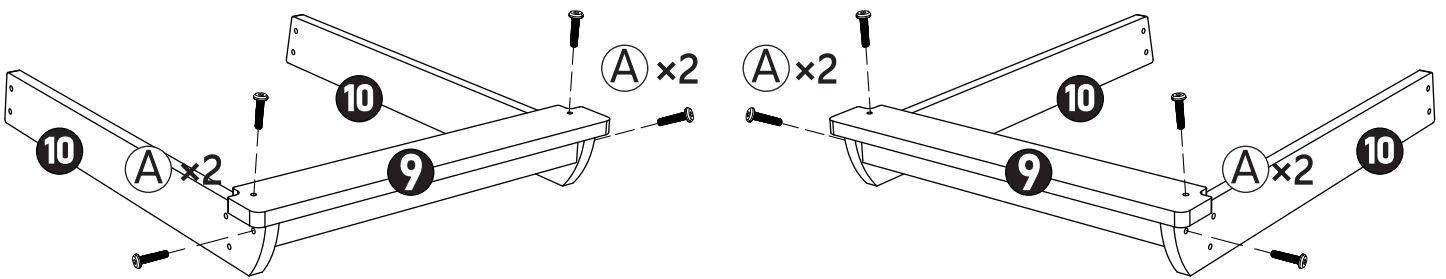
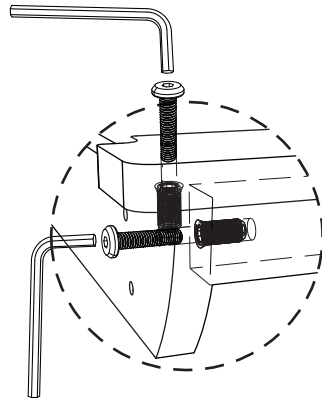

A × 20pc	B × 40pc	C × 28pc
		
Hexagon socket head cap screw M6x40	Hexagon socket head cap screw M6x60	Flange Nylon Lock Nut HN.
D × 1pc	E × 1pc	F × 2pc
		
Allen Wrench	Wrench	Umbrella Cover

STEP 1

- A  x8
- D  x1





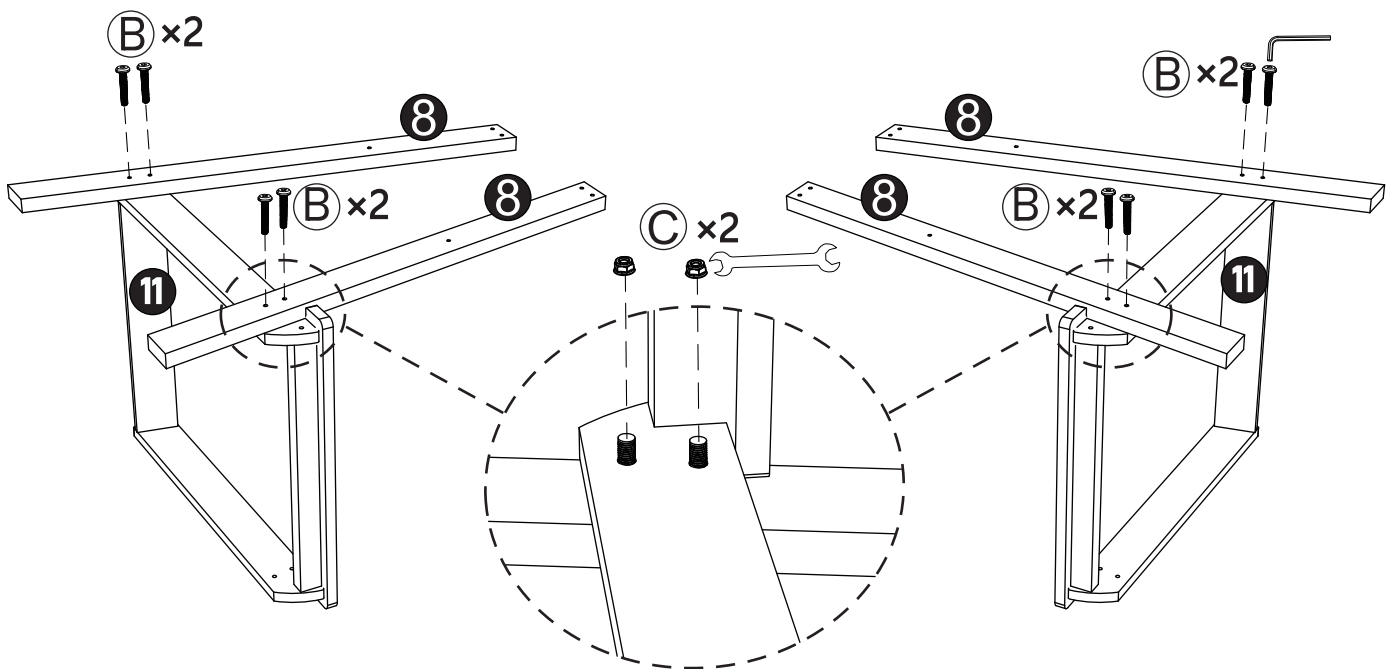

STEP 2

- B  x8
- C  x4
- D  x1
- E  x1





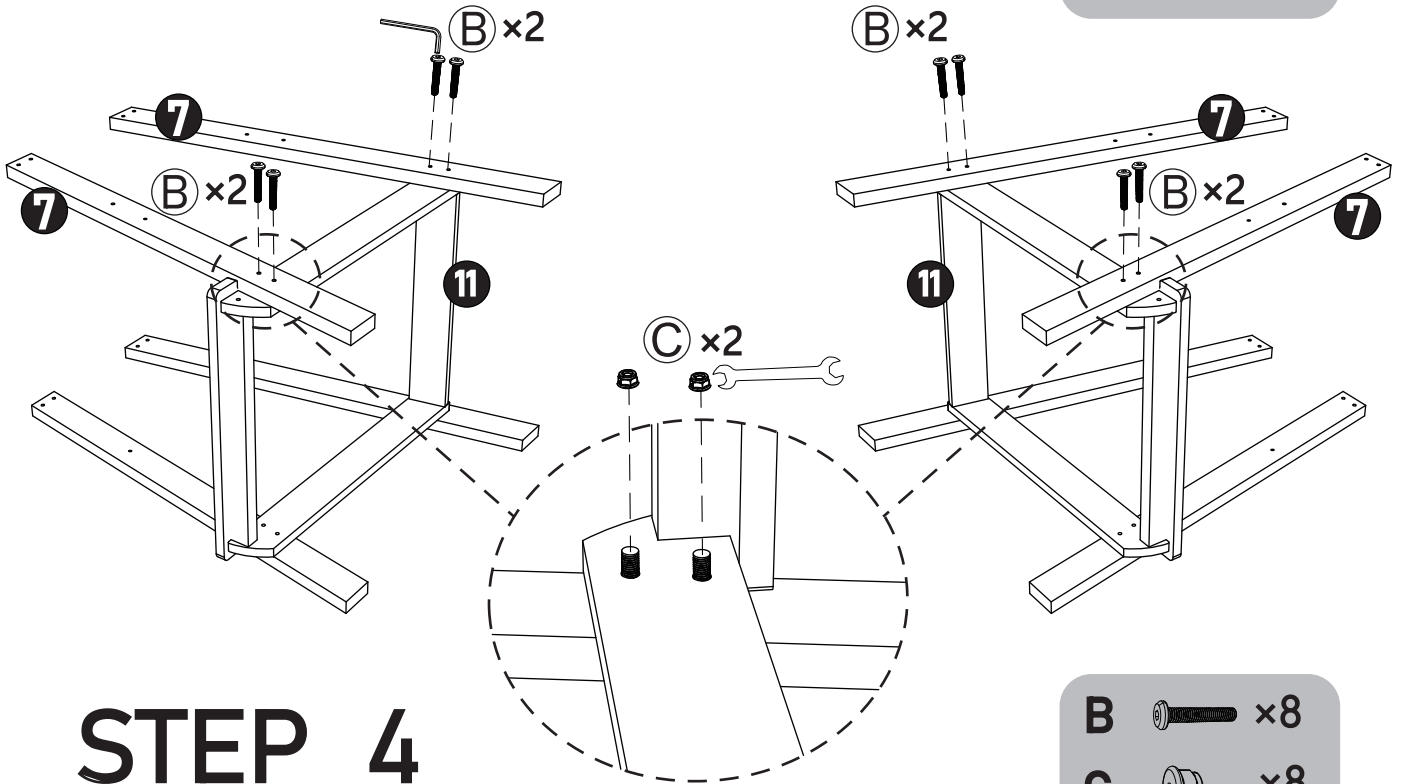

STEP 3

- B  x8
- C  x4
- D  x1
- E  x1





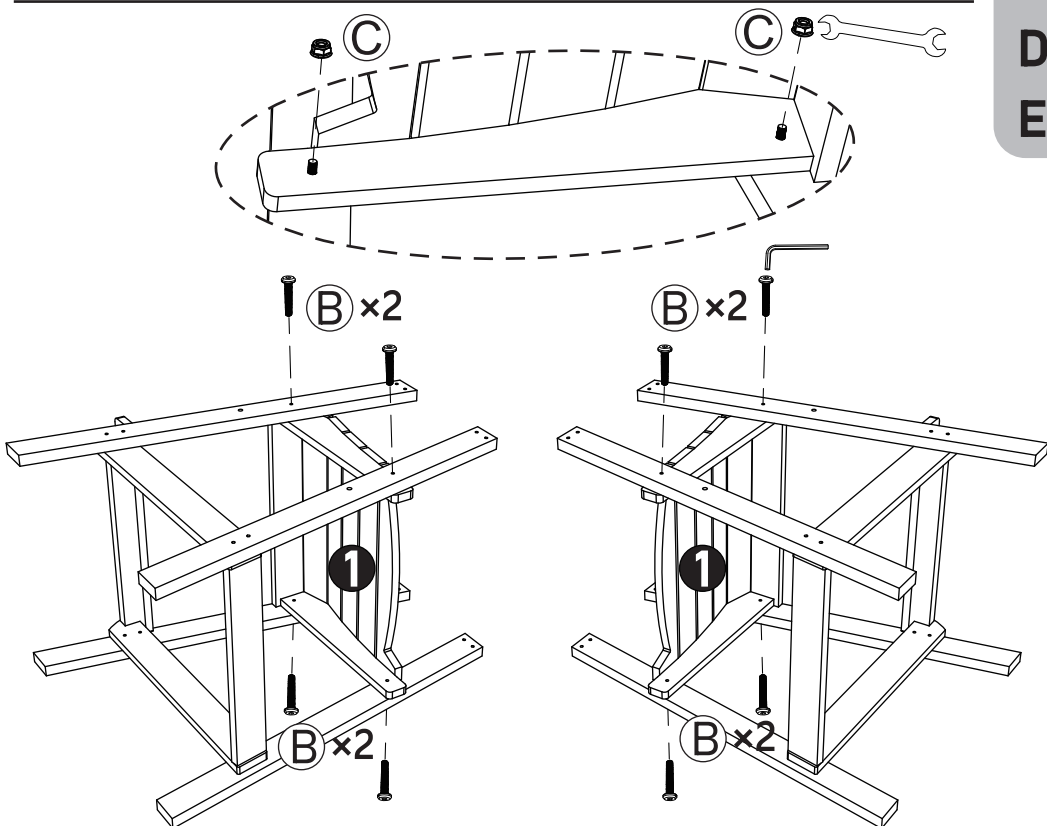

STEP 4

- B  x8
- C  x8
- D  x1
- E  x1



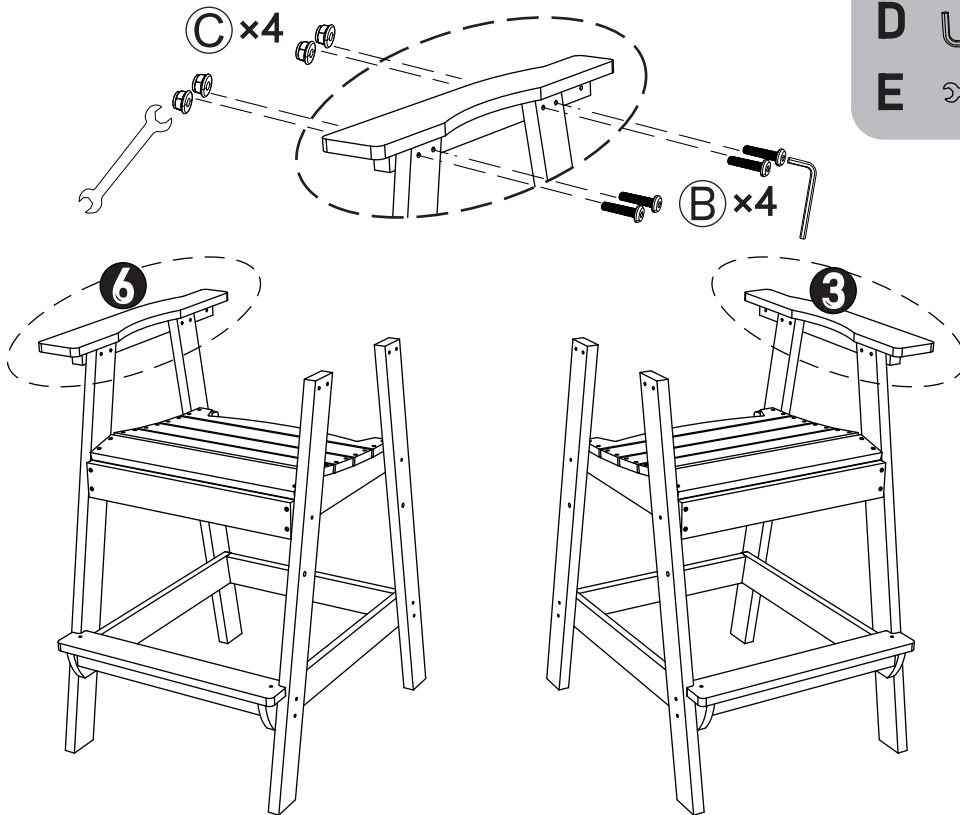

STEP 5

- B**  ×8
- C**  ×8
- D**  ×1
- E**  ×1





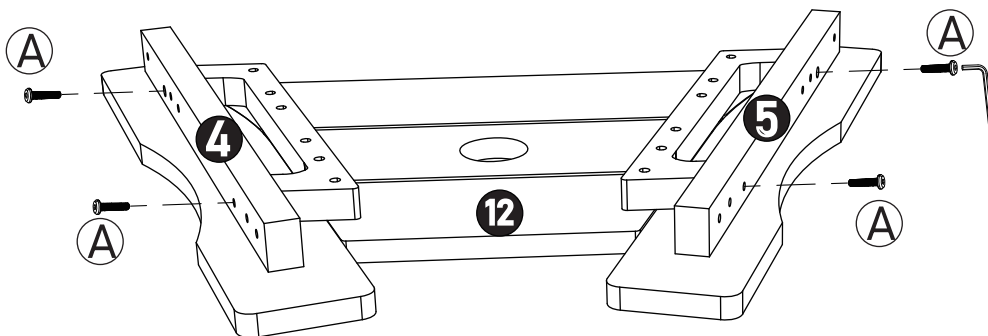

STEP 6

- A**  ×4
- D**  ×1

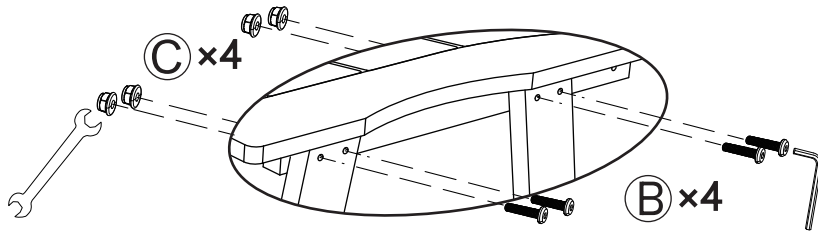

STEP 7



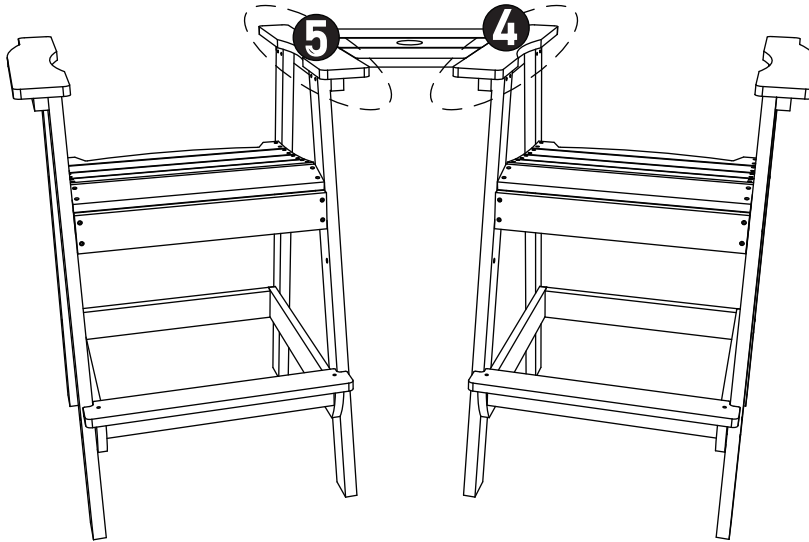

- B**  x8
- C**  x8
- D**  x1
- E**  x1



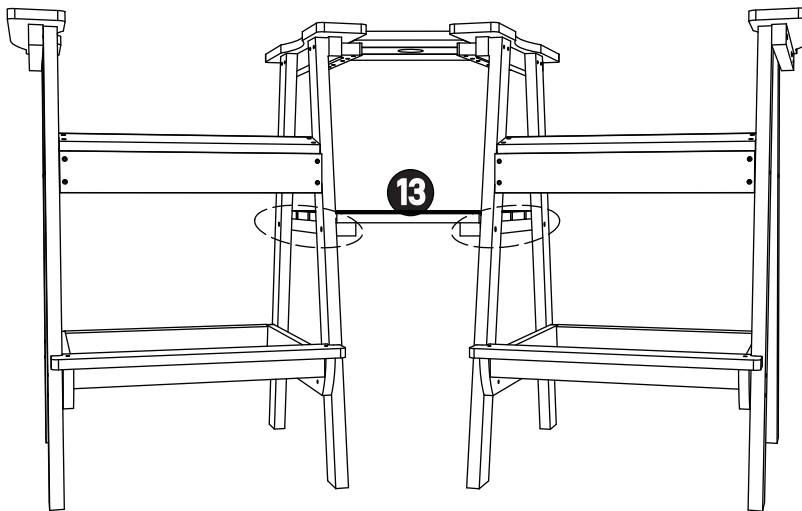



STEP 8

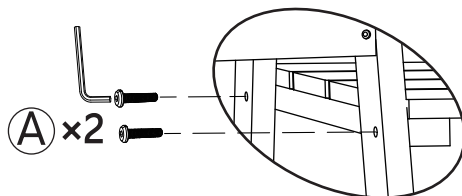

- A**  x4
- D**  x1



STEP 9

- A  x4
- B  x4
- D  x1
- F  x2

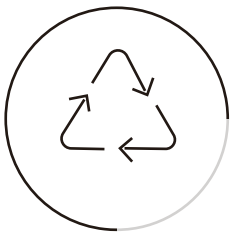
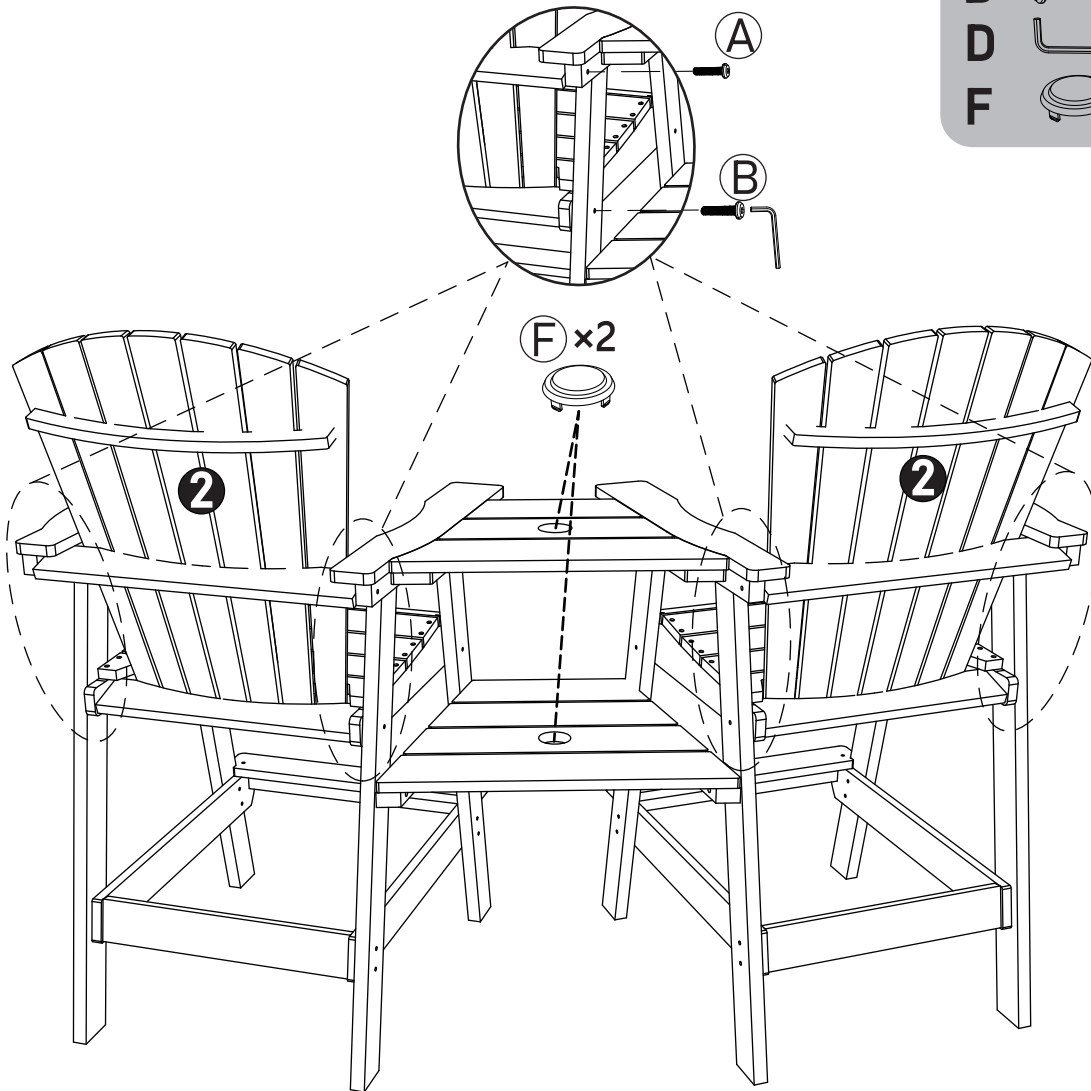

LONG LASTING

100% recyclable materials for a healthy planet

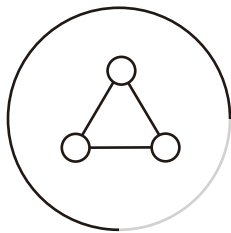

STURDY

Long lasting chair, won't crack splinter rot

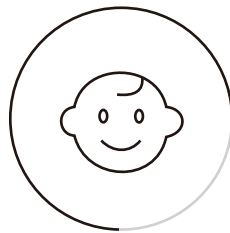

SAFETY

Free from harmful chemicals



LOW-MAINTENANCE

Easily clearing with soap and fresh water

THANK YOU FOR SHOPPING WITH US!

WARRANTY INFORMATION

- We offer a limited number of free extended 1-year warranties, including VIP customer service privileges.
- From the activation date, we offer a no-questions-asked warranty against defects in materials and workmanship. During this period, we will repair or replace any defective component at our discretion.
- This warranty is limited to manufacturing defects associated with the products and does not cover any damage caused by improperly installed handled or abused by user, nor to any unit which has been repaired or altered by unauthorized repair companies.
- Under no circumstances will the customer be entitled to warranty consequential or incidental damages. This limited 1-year warranty will only grant customers certain legal rights; Customers may have other rights according to different state laws.

CUSTOMER SERVICE

If you have any questions or need assistance, feel free to contact our brand's official customer service anytime

To help us locate your order, please include your Order Number#. Our 24-hour customer service team will be happy to assist you, and we typically respond within hours.

Customer Service Team