

# ASSEMBLY INSTRUCTIONS

SKU# 92530

## Before beginning

Unpack all parts and hardware to ensure you have all needed components for assembly.

Read this guide cover before beginning assembly.

Assemble this item on a soft surface such as carpet to protect finish.

Proper assembly of this item requires 2 people & 20 minutes to assemble.

## CARE INSTRUCTIONS

Wipe with a soft dry cloth. To protect finish, avoid the use of chemicals and household cleaners, Any liquid spilled on the table should be cleaned up immediately with a damp cloth.

TOP

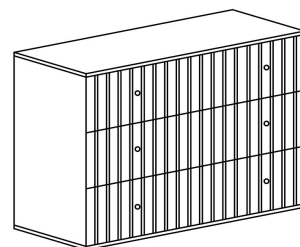

A

LEG

BX2

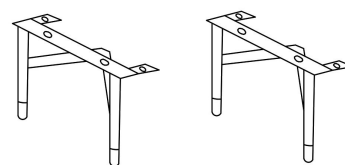

SUPPORT

C

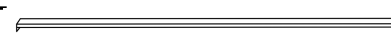

## HOW TO ASSEMBLY

**STEP-1** Place the dining top upside down on rug.

**STEP -2** Insert allen bolt ( D ) with flat washer ( E ) then tighten with allen key ( F ).

**STEP -3** Insert bolt ( G ) then tighten with spanner ( H ).

**STEP -4** Turn the Dining upside top. Dining is ready to use.

## Hardware & Tool Required:-

No.	Sketch	Description	Size	Qty.	Ext.
D		Allen bolt	(1"X0.23")	12	1
E		Washer	(1"X0.19")	12	1
F		Allen key	(0.19")	1	0
G		Allen bolt	(0.75"X0.19")	2	1
H		Washer	(0.75"/0.19")	2	1
I		Allen key	(0.15")	1	0

# STEP -1

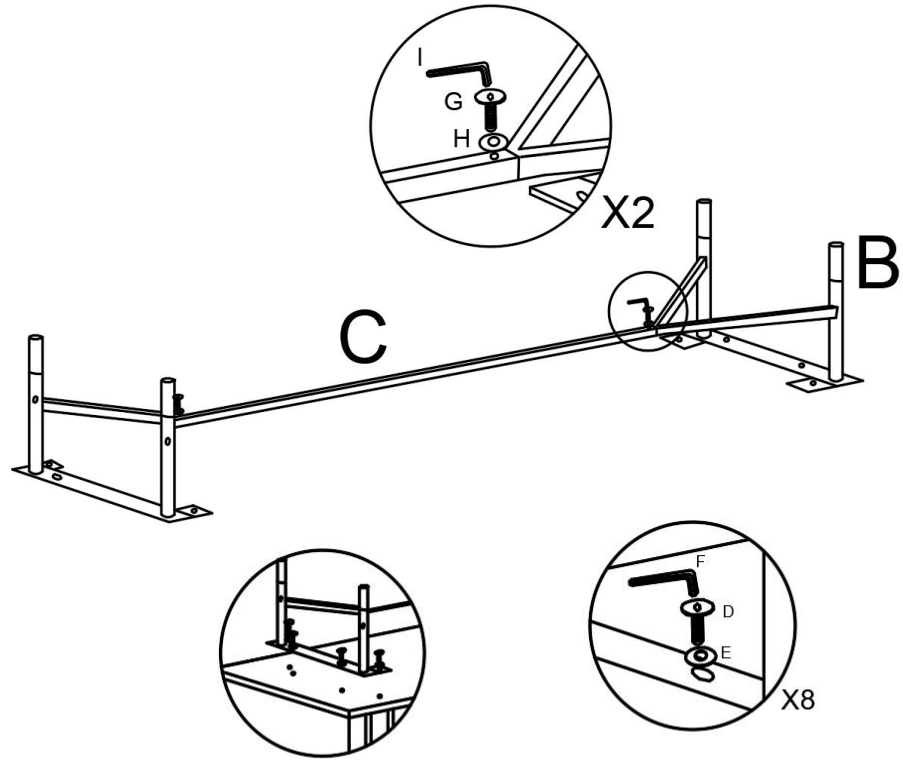

# STEP -2

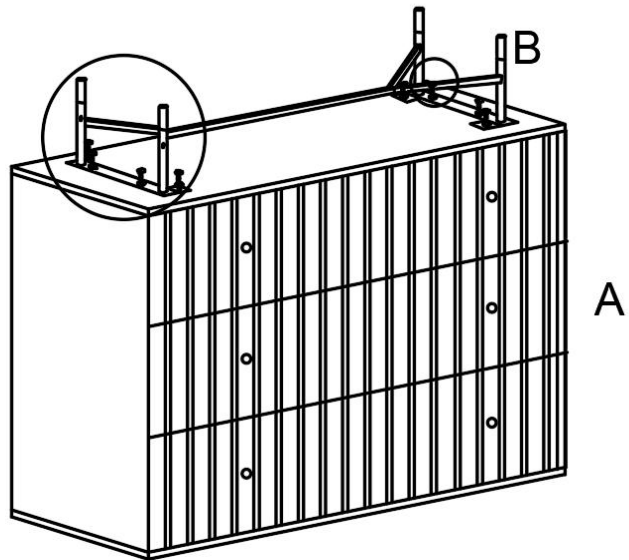

# STEP -3

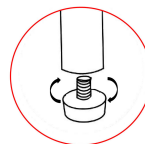
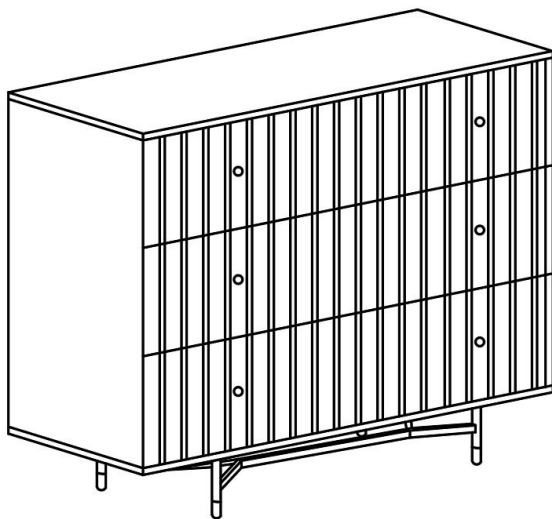

Tip for leveling of product:  
When the product rests on an uneven floor surface it will appear to be unbalanced to aid in levelling, try adjusting the levelers located on the bottom of each foot.

## FINAL PRODUCT