









Assembly Instructions

CAUTION: You must read this before you proceed.

Care & Maintenance

- ⊘  • Not for commercial use. For residential use only.
- ⊘  • Do not put hot items directly on furniture surface.
- ⊘  • Do not clean furniture with harsh cleansers or polish.
- ✓  • To obtain the longest lifespan of your outdoor products, minimizing exposure to direct sunlight is recommended.
- ⊘  • Children should not climb or jump on the furniture.
- ⊘  • Do not write on furniture without a padded barrier to protect the surface.
- ✓  • To obtain the longest lifespan of your outdoor products, avoid extended and lengthy exposure to rain, snow, and direct sunshine. Whenever possible cover the product and /or place under patio or awnings.
- ⊘  • Stains may be removed with mild soap solution and damp cloth.
- ✓  • Dust and pick-up spills using a clean, non-colored, lint- free cloth.

Please look in the Table Top for hardware packs

TABLE

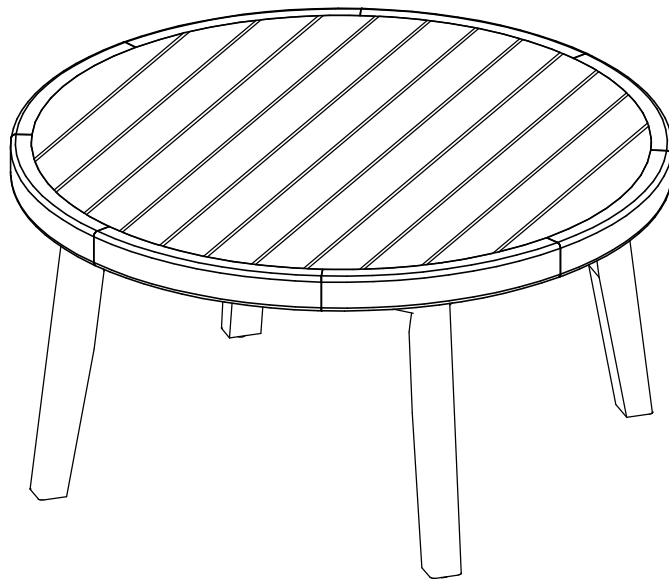



CAUTION: This Table is NOT a TOY.

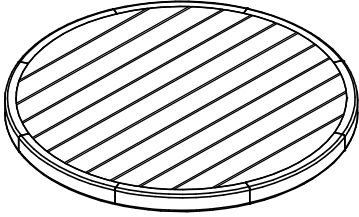

Keep your child / children at bay in the process of assembly.

For turning the Table and to prevent damage to the Table, 2 persons may be needed to execute this action.

Part list

Label	Picture	Description	Qty
H	 A line drawing of an oval table top with diagonal hatching across its surface and a raised rim.	Table Top	1
I	 A line drawing of a single, tapered leg with a small notch at the top.	Leg	4

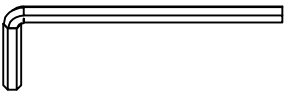
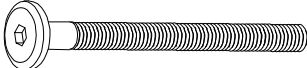



Hardware

Label	Picture	Description	Qty
①	 A line drawing of an L-shaped Allen wrench.	Allen Wrench	1
⑤	 A line drawing of a long bolt with a hexagonal head.	Bolt (M6*55)	9
⑥	 A line drawing of a circular washer with a central hole.	Washer (M6.5*2)	9

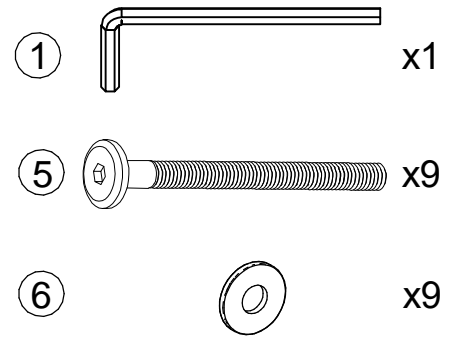
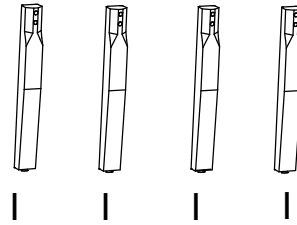
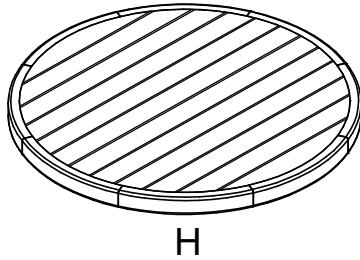
Assembly Preparation

Before Beginning Assembly:



-  • Read instruction, cover to cover-
-  • Have 2 adults on hand for assembly-
-  • Do not assemble on the flooring or carpet-
-  • Assemble on a clean non- marring surface (packing foam)-
-  • Save all packaging until finished-

Assembly Steps

OVERVIEW

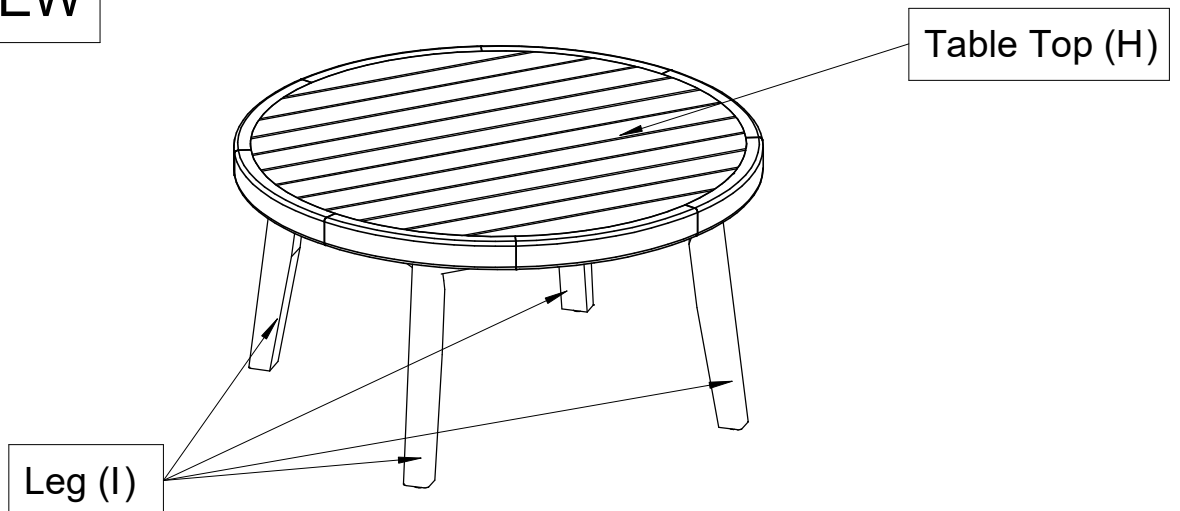

This Table has multiple parts and may require up to some 30 minutes to assemble. To give you an overview of the Table, the above picture is to help you put the various parts into perspective. Please read through the instructions here below to familiarise the parts and steps before assembly.

Step 1

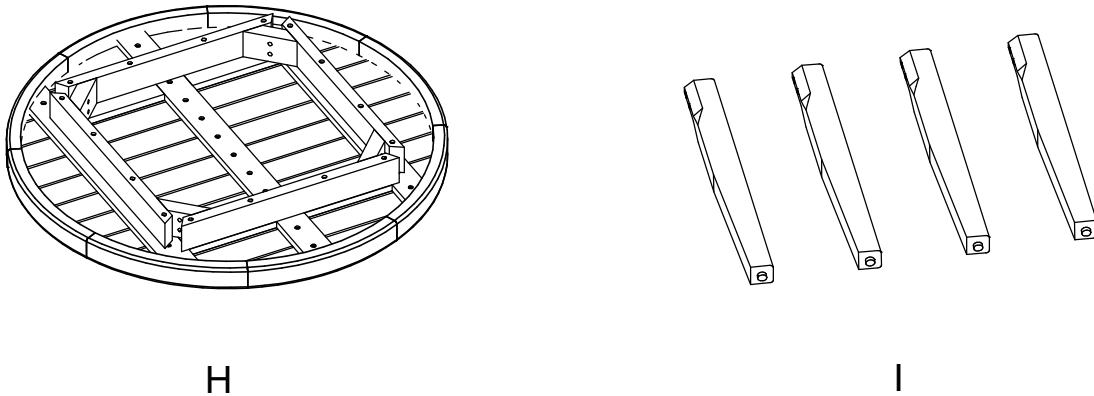

Unpack and place all parts on a clean, non-marring surface.

Step 2

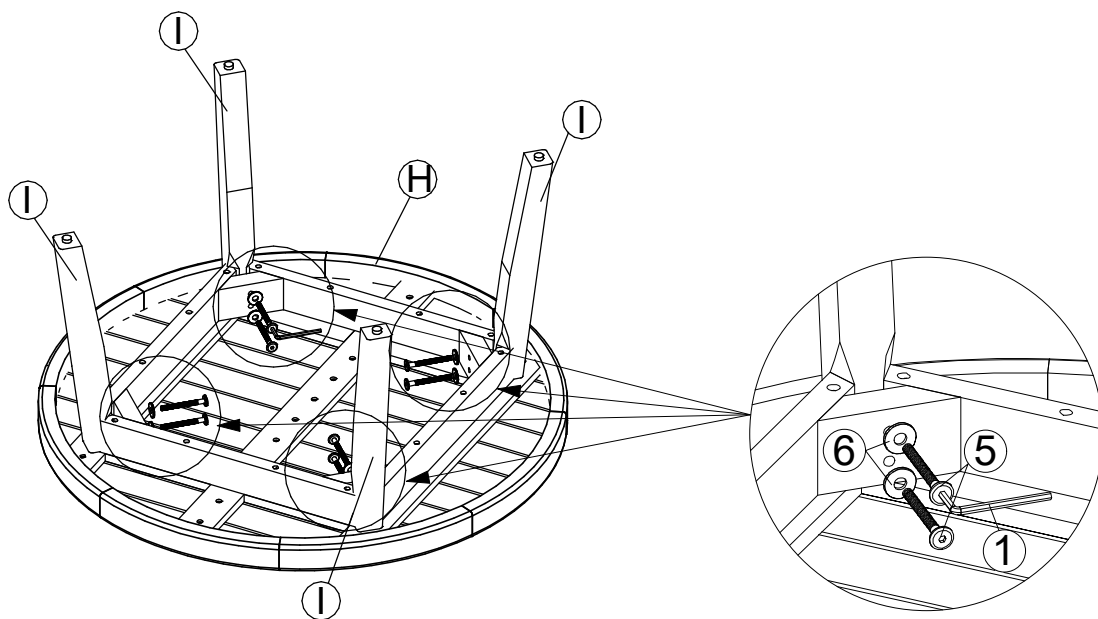

Attach Leg (I) to Table Top (H) by using 2 Bolts (1) and 2 Washers (5) with Allen Wrench () as shown above picture.

Repeat the same process to attach remain Legs.

DO NOT fully tighten the Bolts.

Step 3

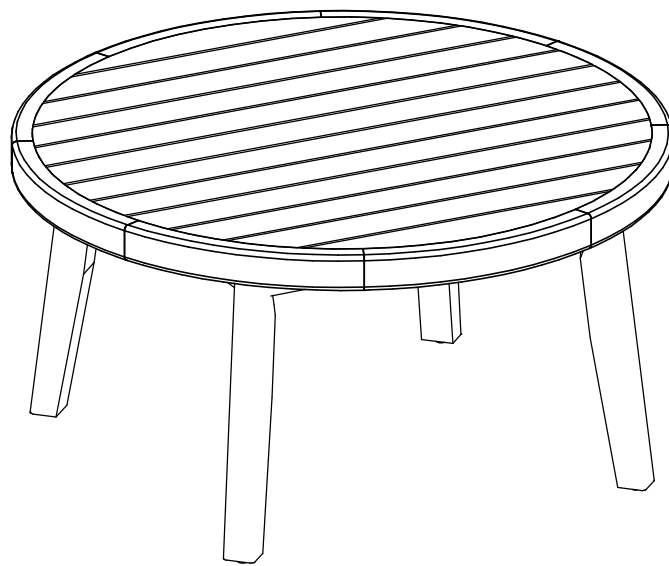

With the help of your adult partners, stand the Table up.
Exert pressure floorwards, onto the Table with both your hands.
This pressure will help the Legs and Table Top reach full alignment status.
Check for wobbles on a LEVEL surface.
If no wobbles are found proceed to tighten the Bolts, Screws in a sequential manner,
until evenly secured.
When tightening the Bolts, Screws tighten sequentially.
Do not tighten any Bolts, Screws fully and then move on towards the next one.
If there are still wobbles, loosen the Bolts, Screws and excute this same process.
Your Table is ready for use.
This Table can only be used on a flat, level surface.