

ATTENTION



- ADULT ASSEMBLY ONLY.
- KEEP SMALL ACCESSORIES OUT OF THE REACH OF CHILDREN UNTIL ASSEMBLY IS COMPLETE.
- TIGHTEN EVERY SCREW TO KEEP THE BOOKSHELF STABLE.
- ENSURE THAT THE BOOKSHELF IS PLACED STABLE BEFORE USE.
- DO NOT CLIMB OR HANG FROM THE BOOKSHELF.
- REGULARLY INSPECT AND TIGHTEN ANY LOOSE SCREWS.

PARTS LIST



PLEASE ENSURE THAT THE BOOKSHELF IS INTACT AND UNDA MAGED BEFORE ASSEMBLY. IF THERE ARE ANY ISSUES, PLEASE CONTACT US PROMPTLY

A ×1

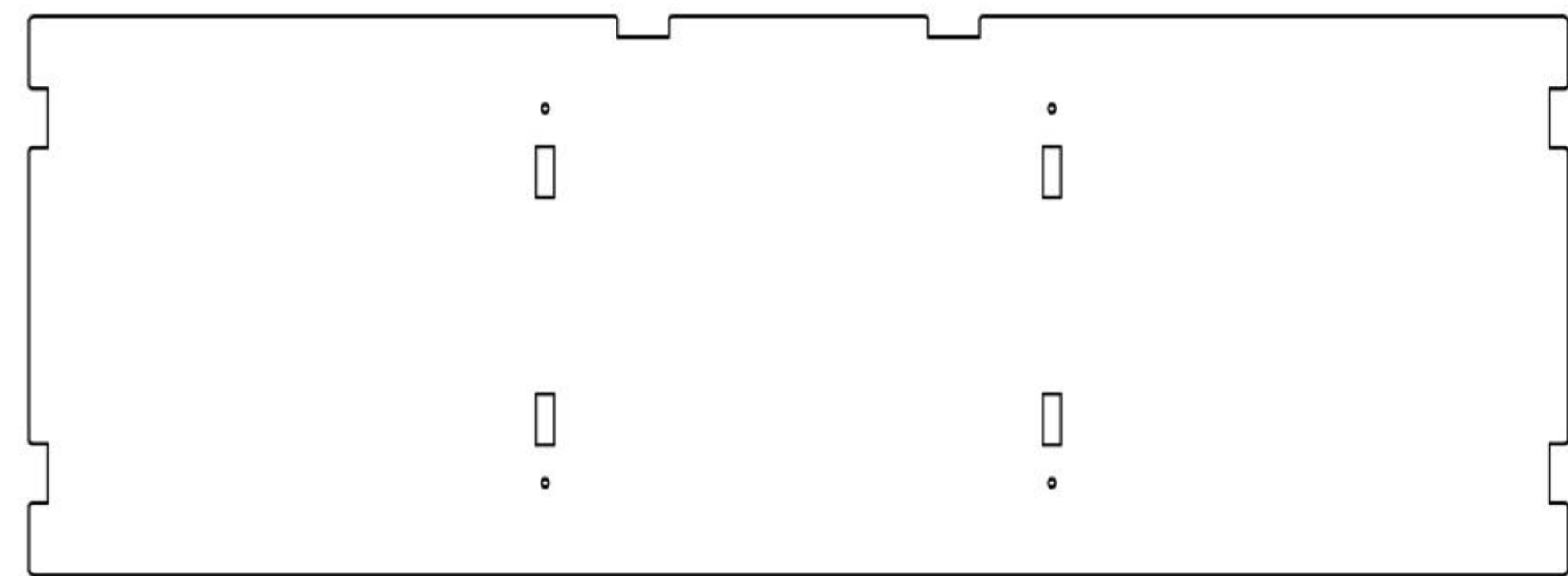

B ×1

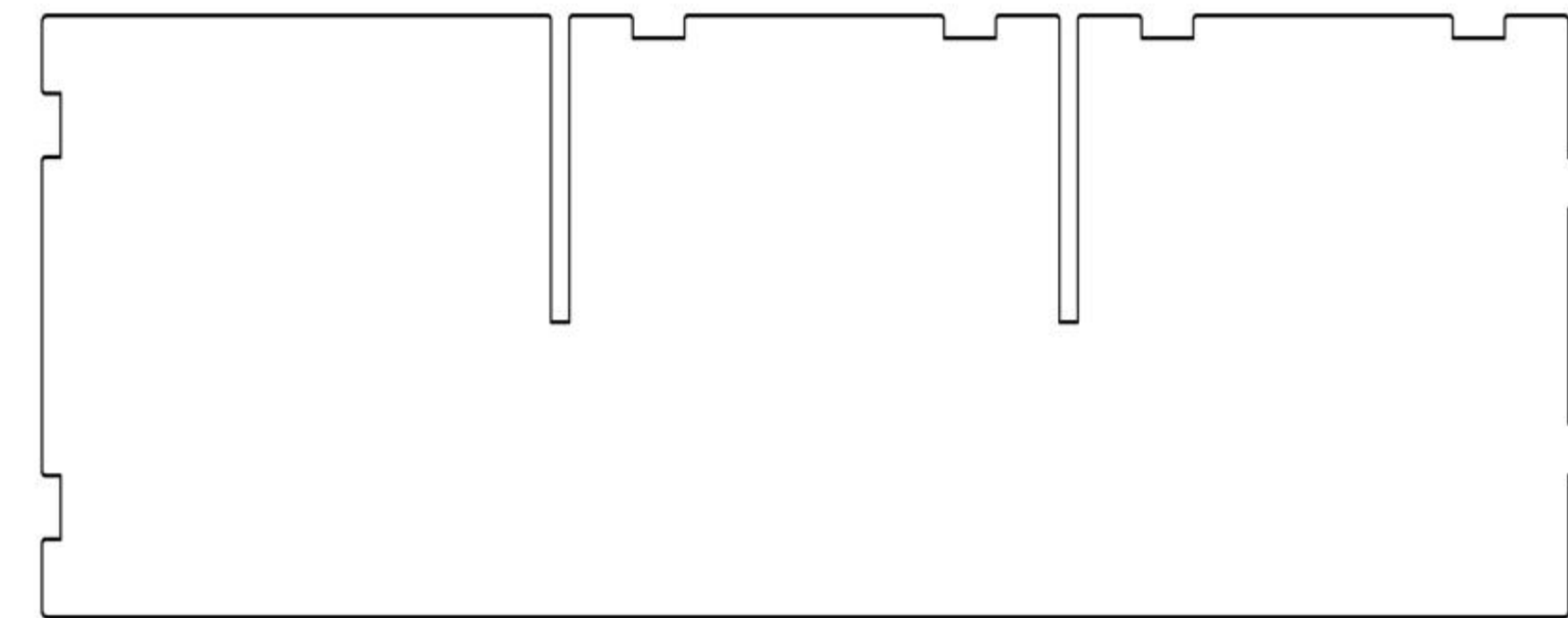

C ×1

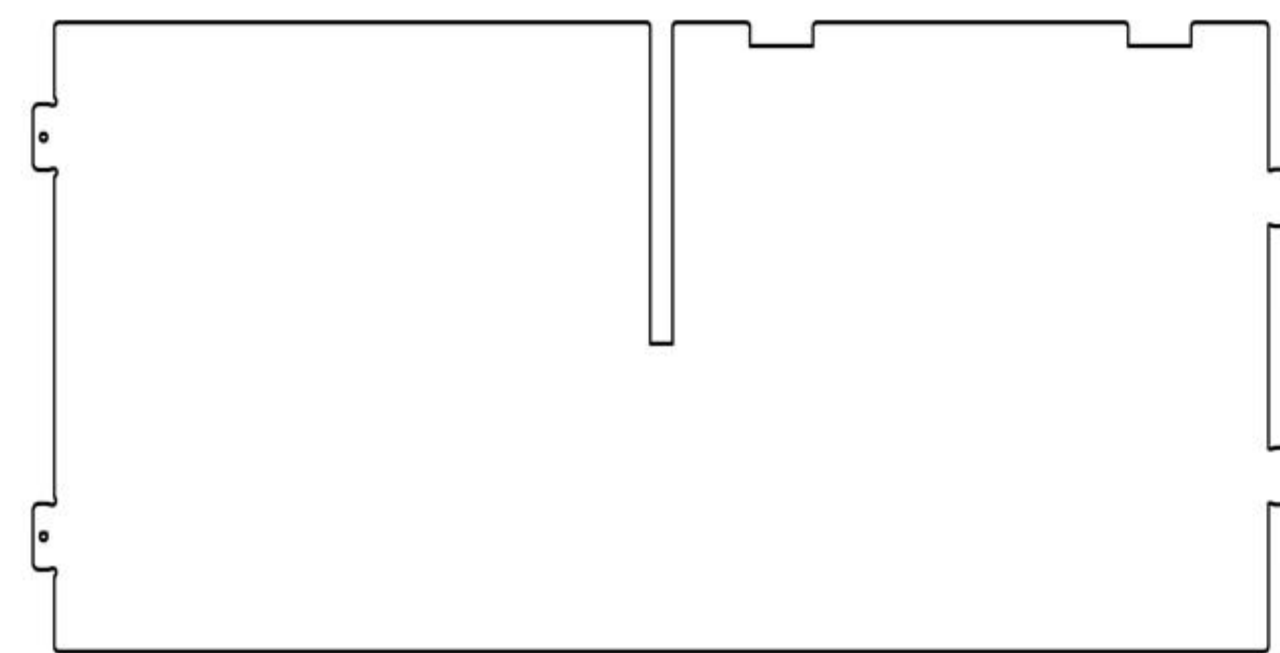

D ×1

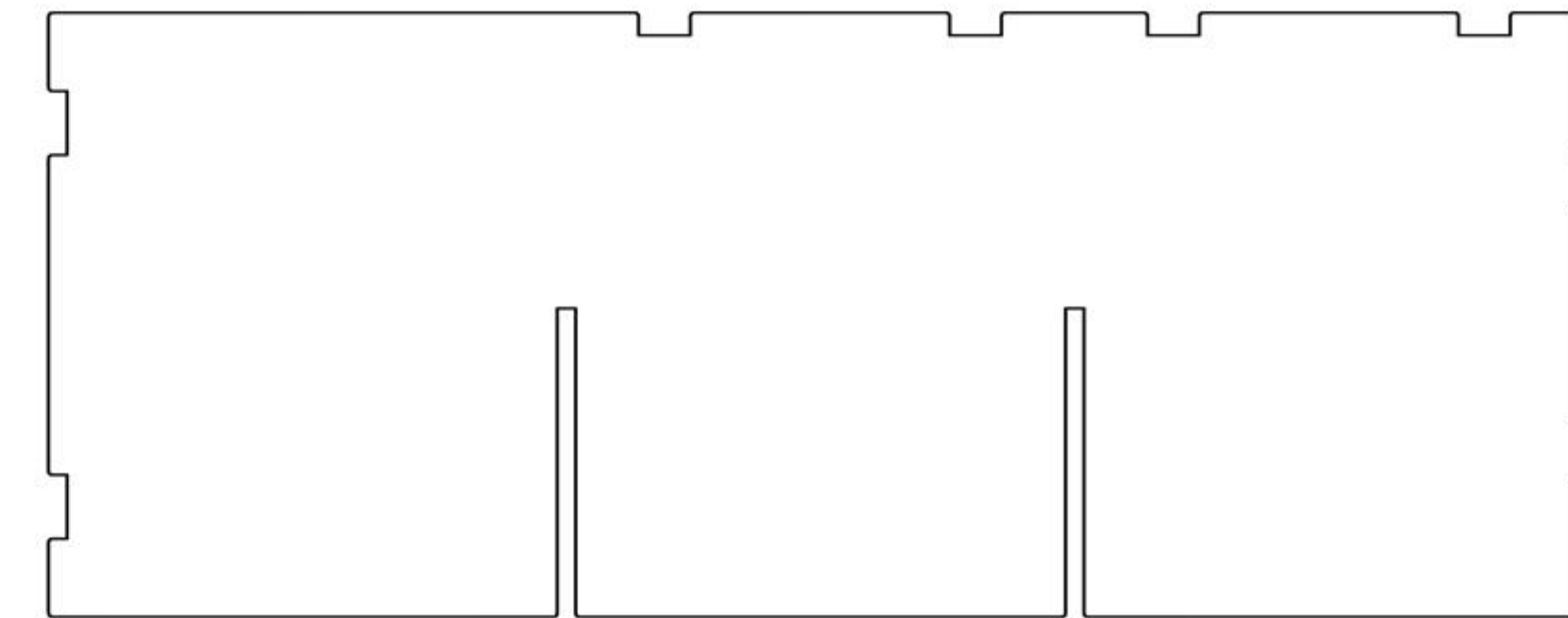

E ×1

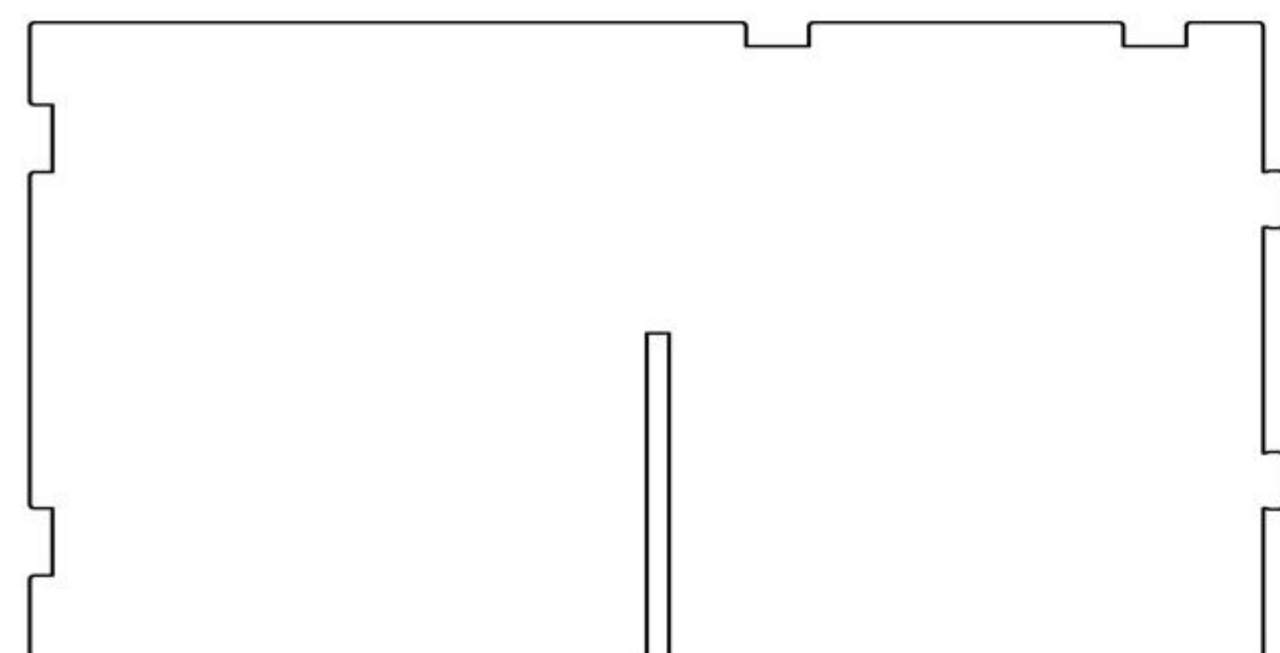

F ×1

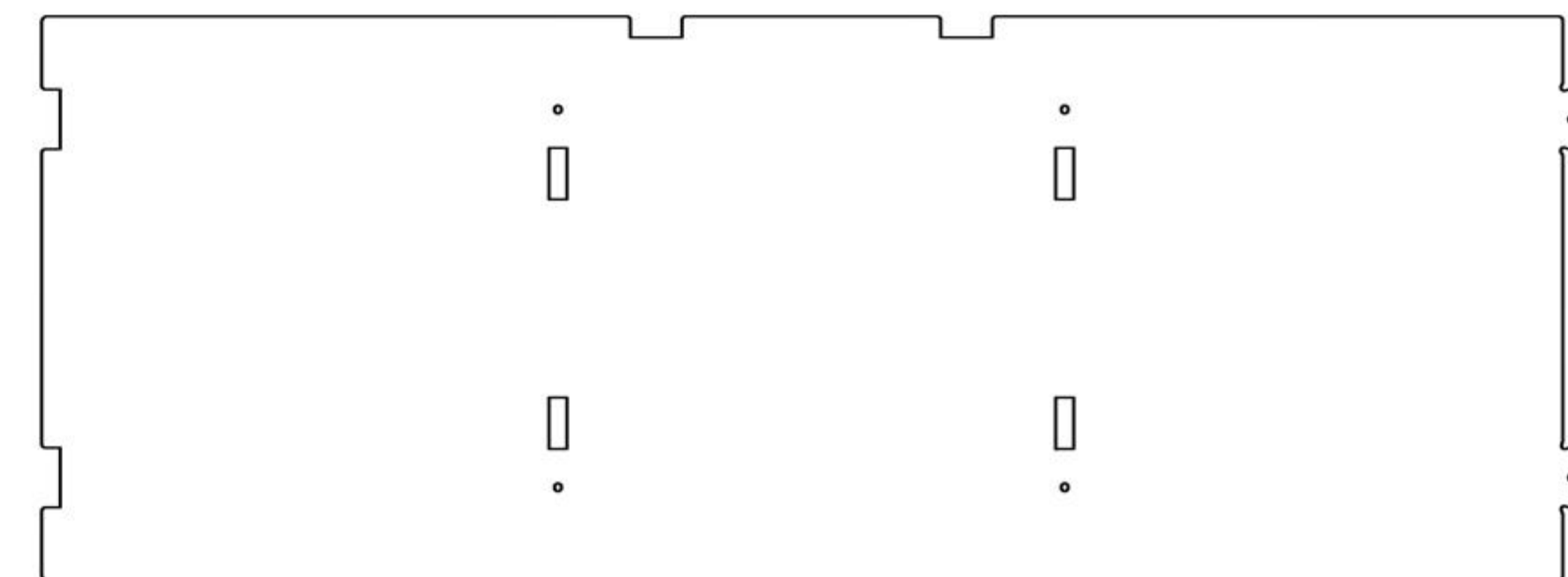

G ×2

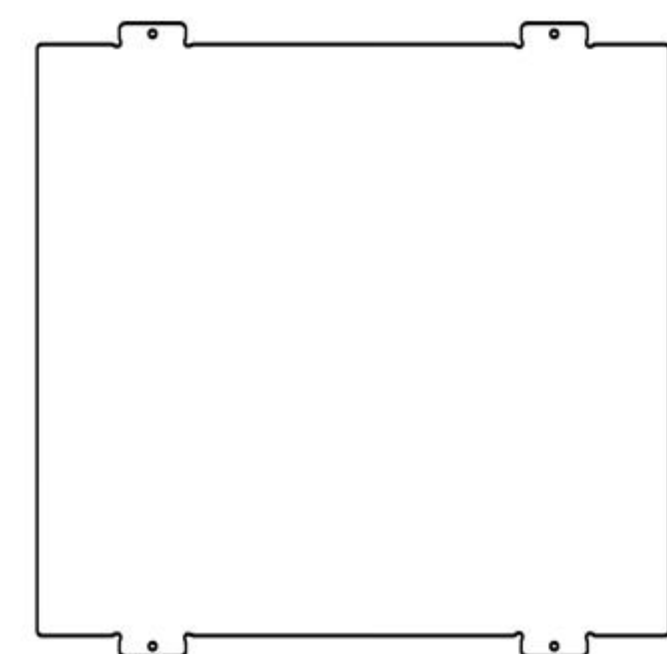

H ×2

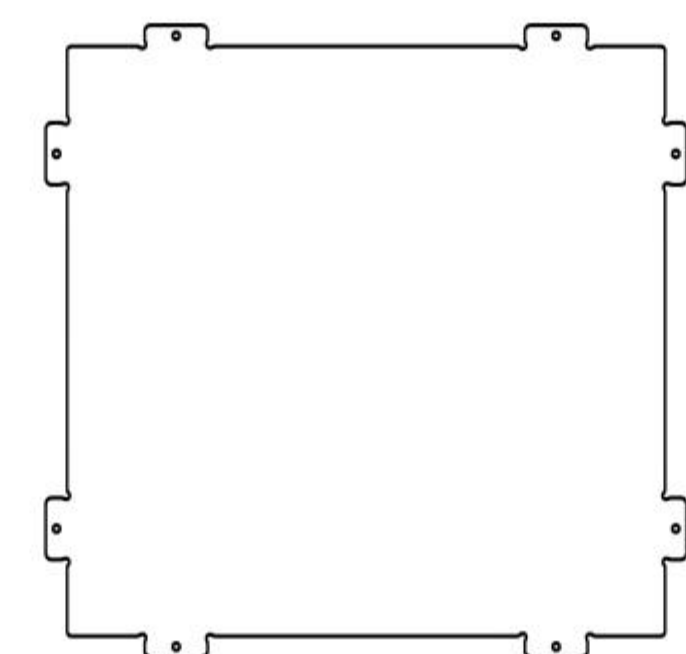

NON-SLIP MAT ×6



3.5 * 25 SCREWS ×36



SCREWDRIVER ×1

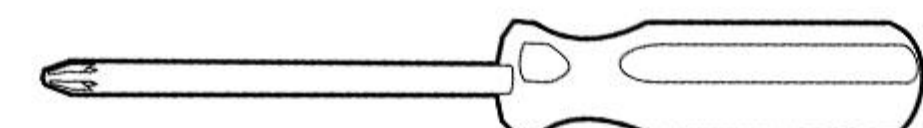

GLOVES ×1

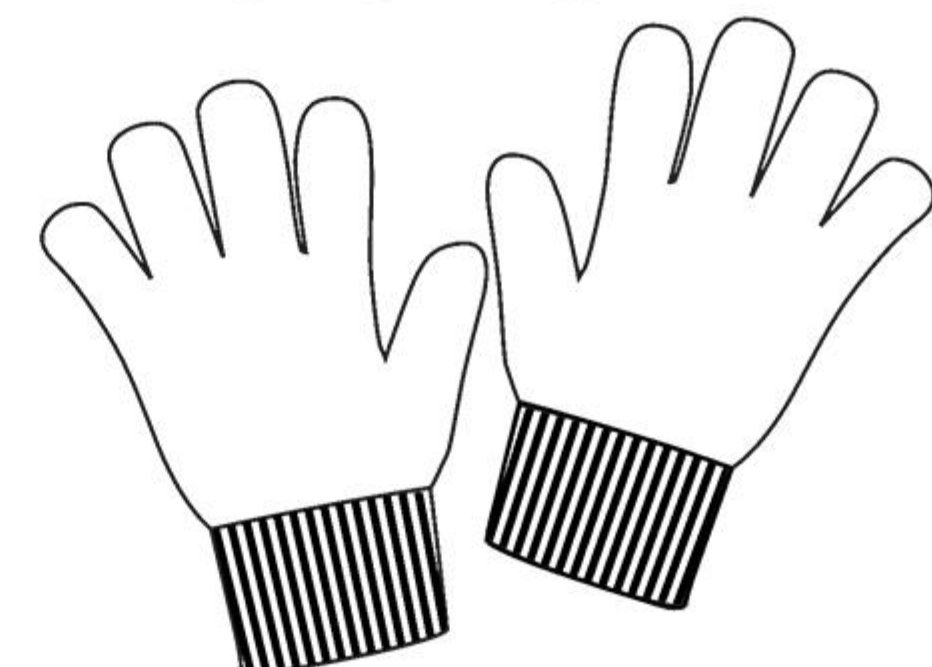

SANDPAPER ×1

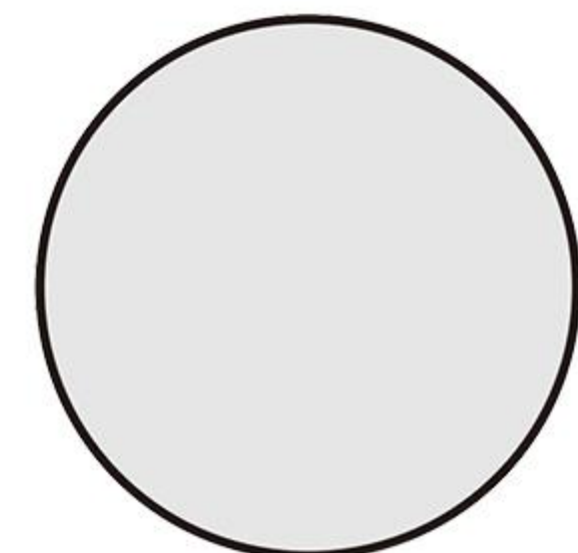

ASSEMBLY INSTRUCTIONS

01 A + B

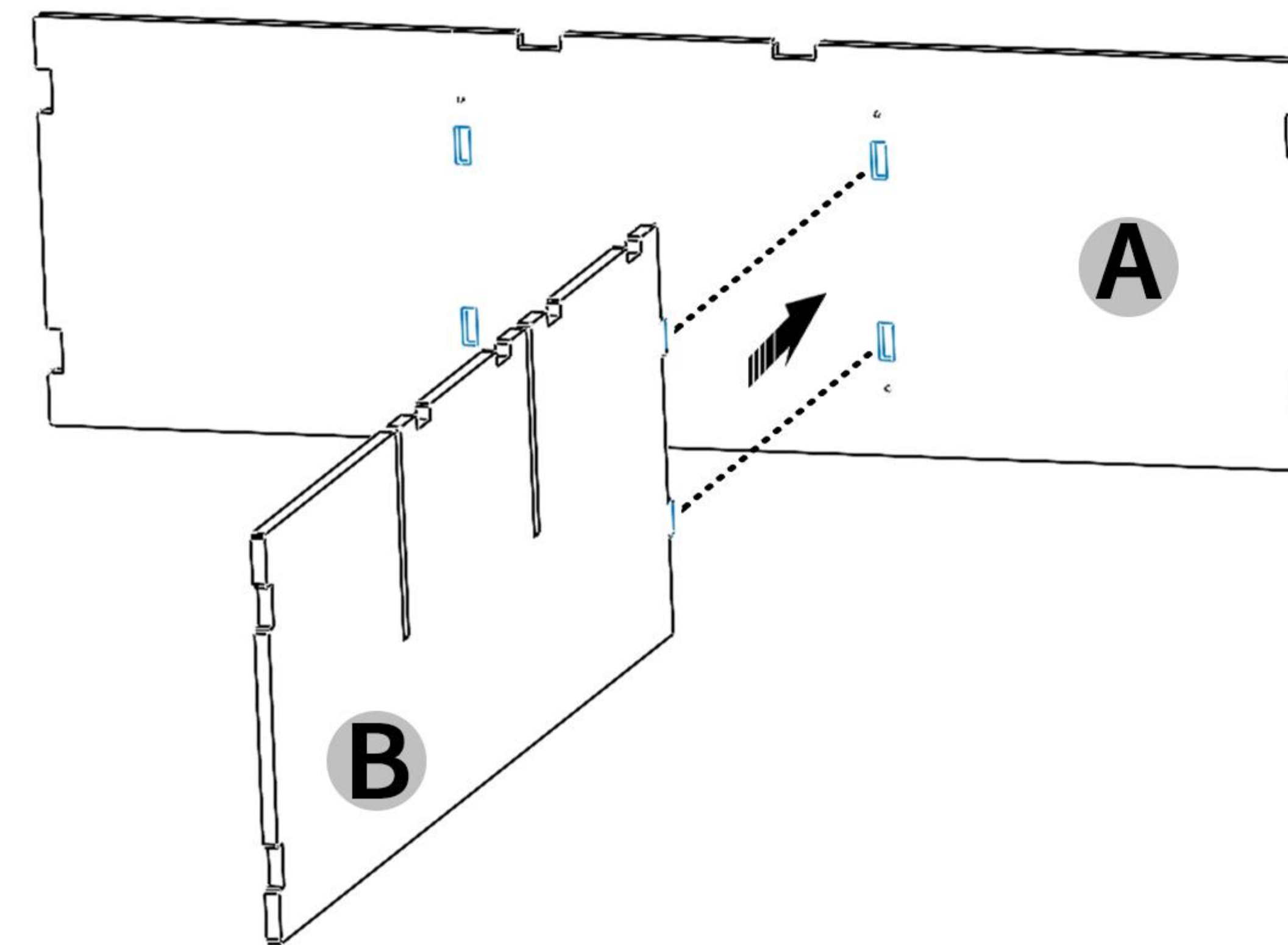

02 A + C

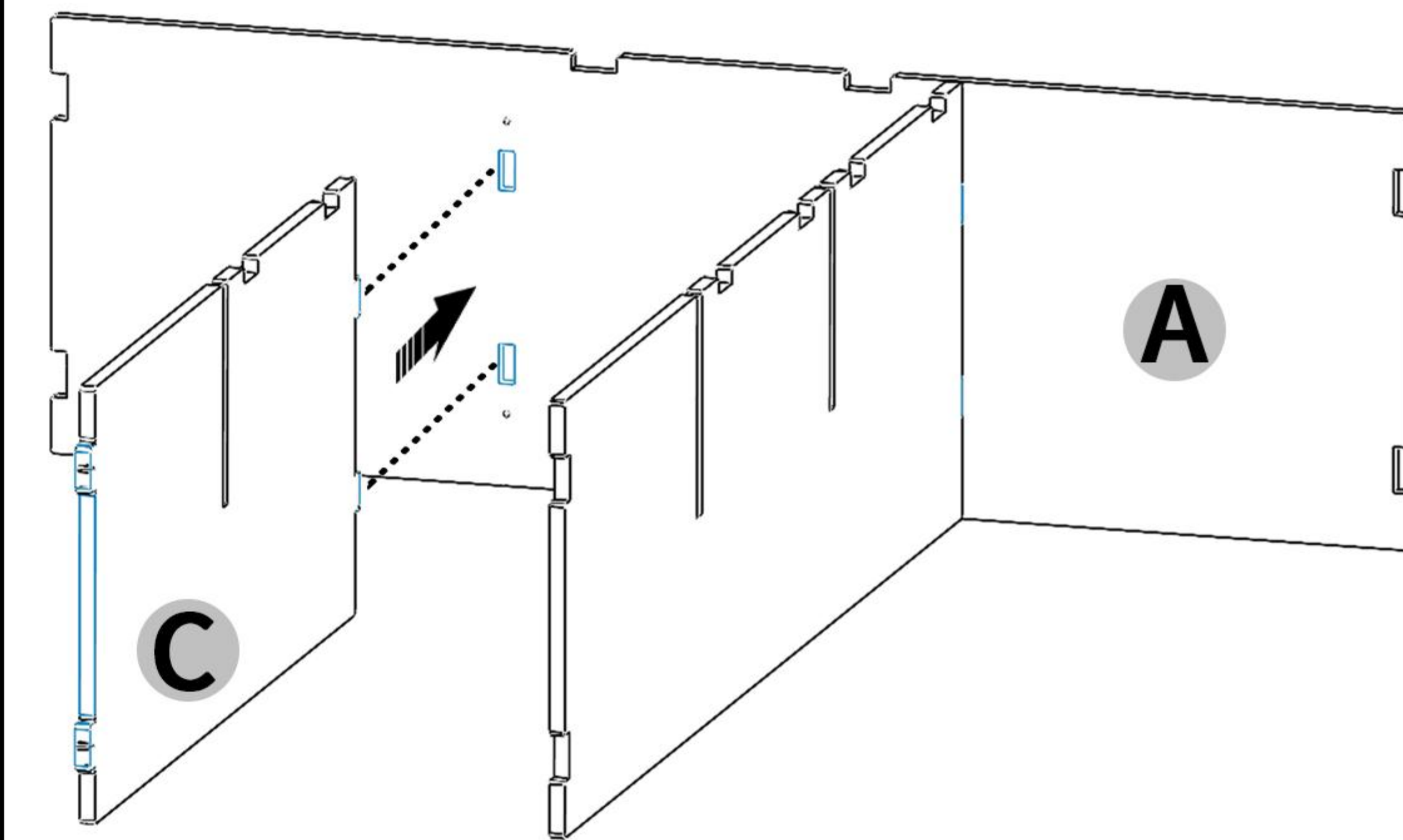

03 + D

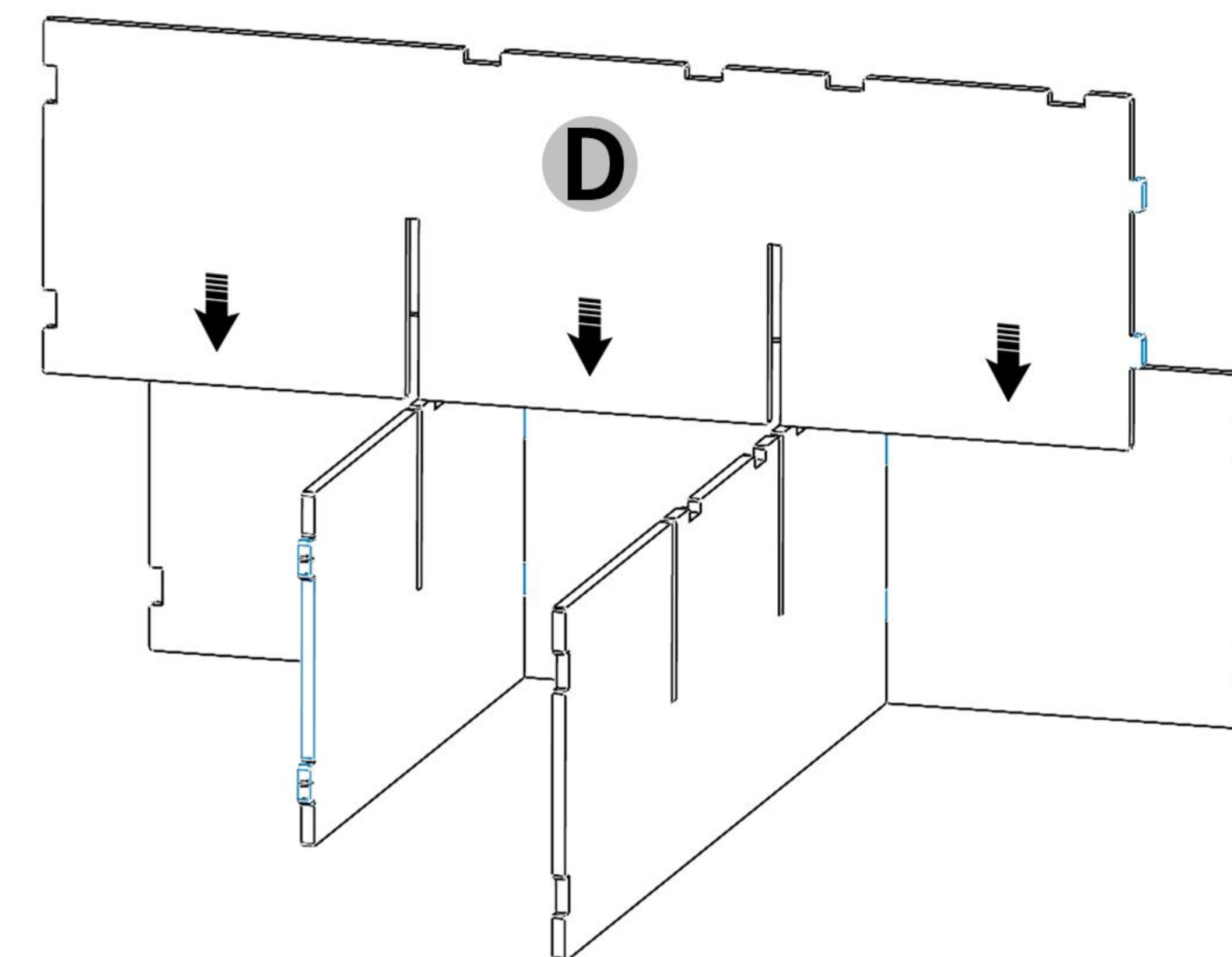

04 + E

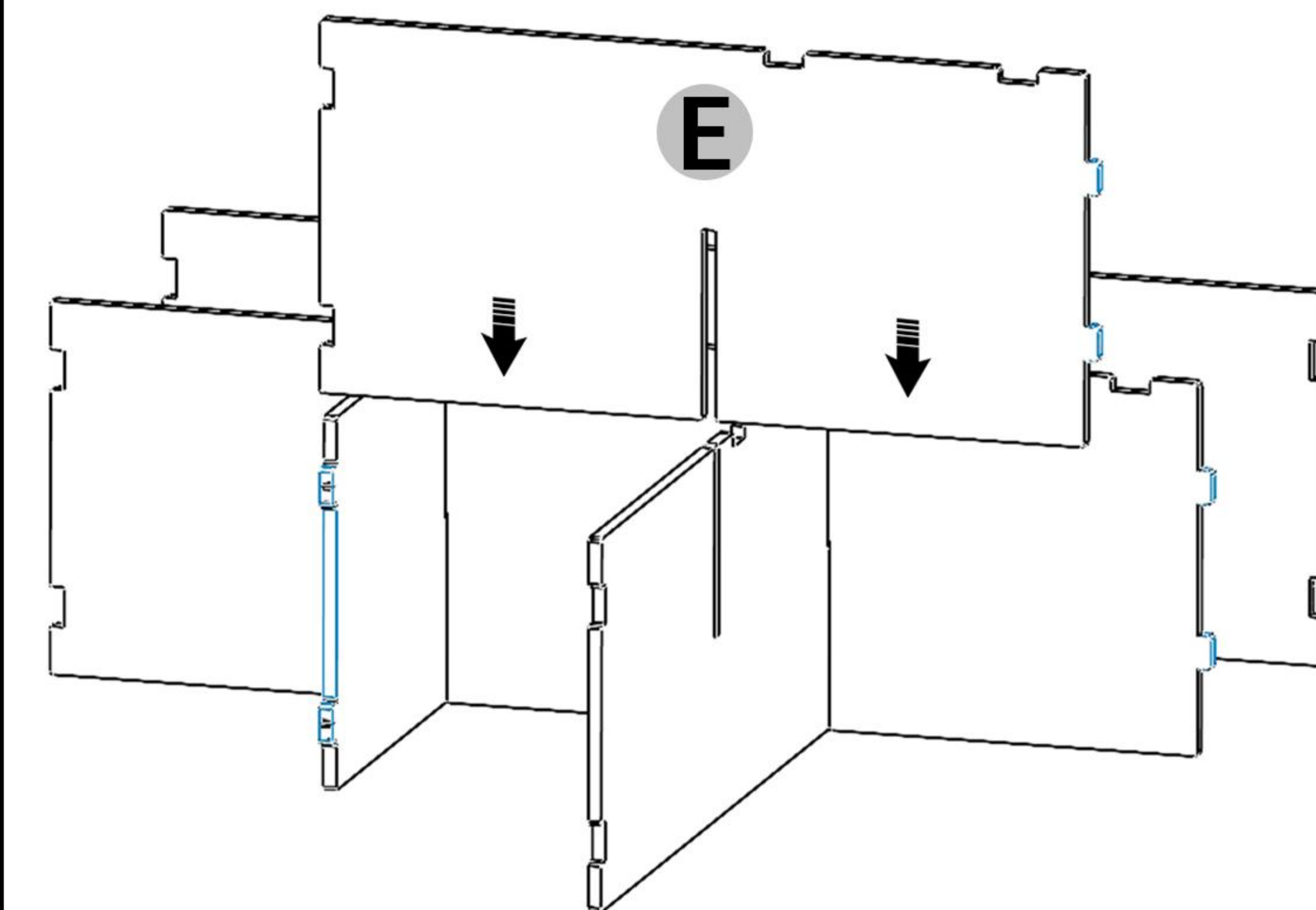

05 + F

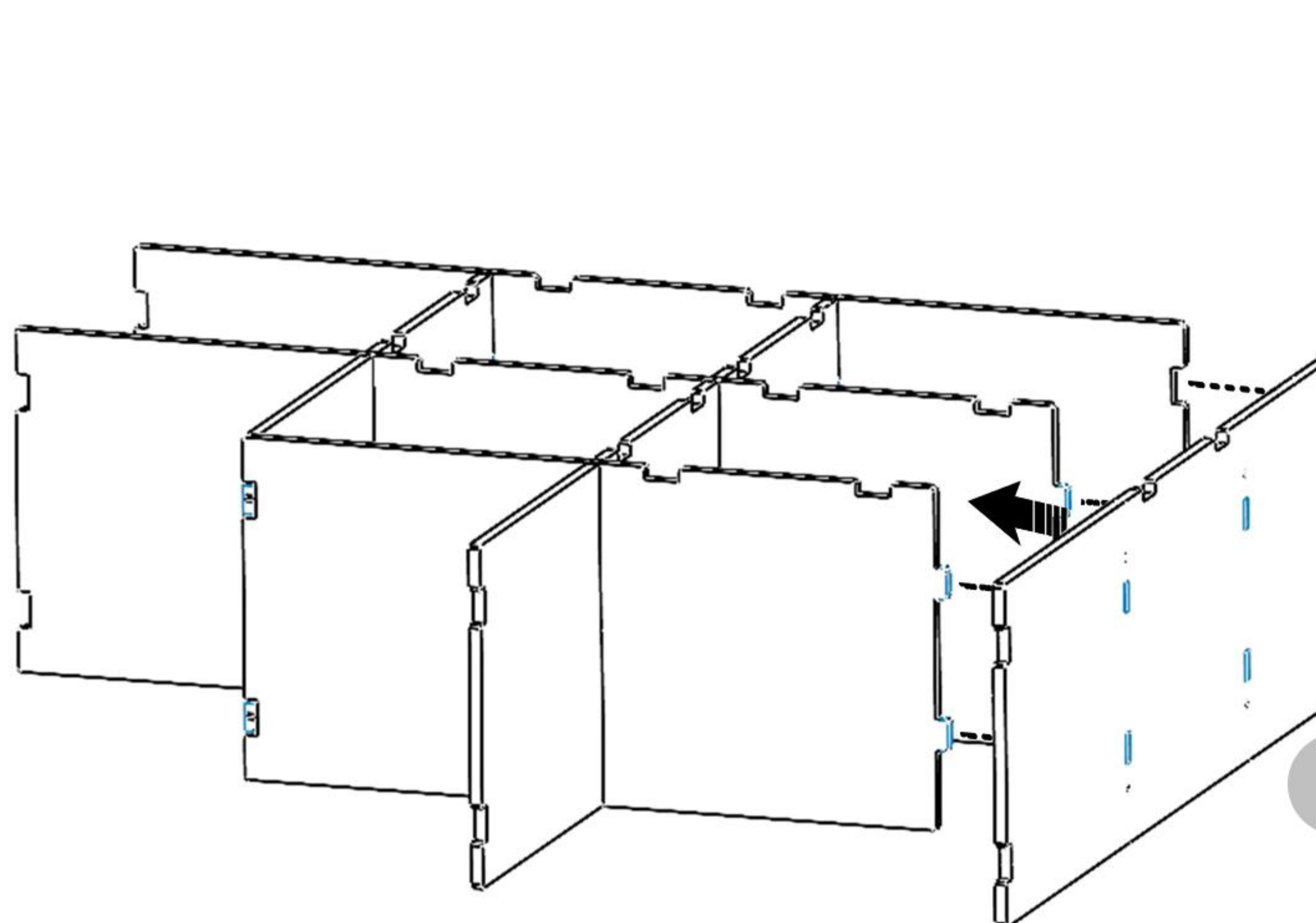

06 + G₁

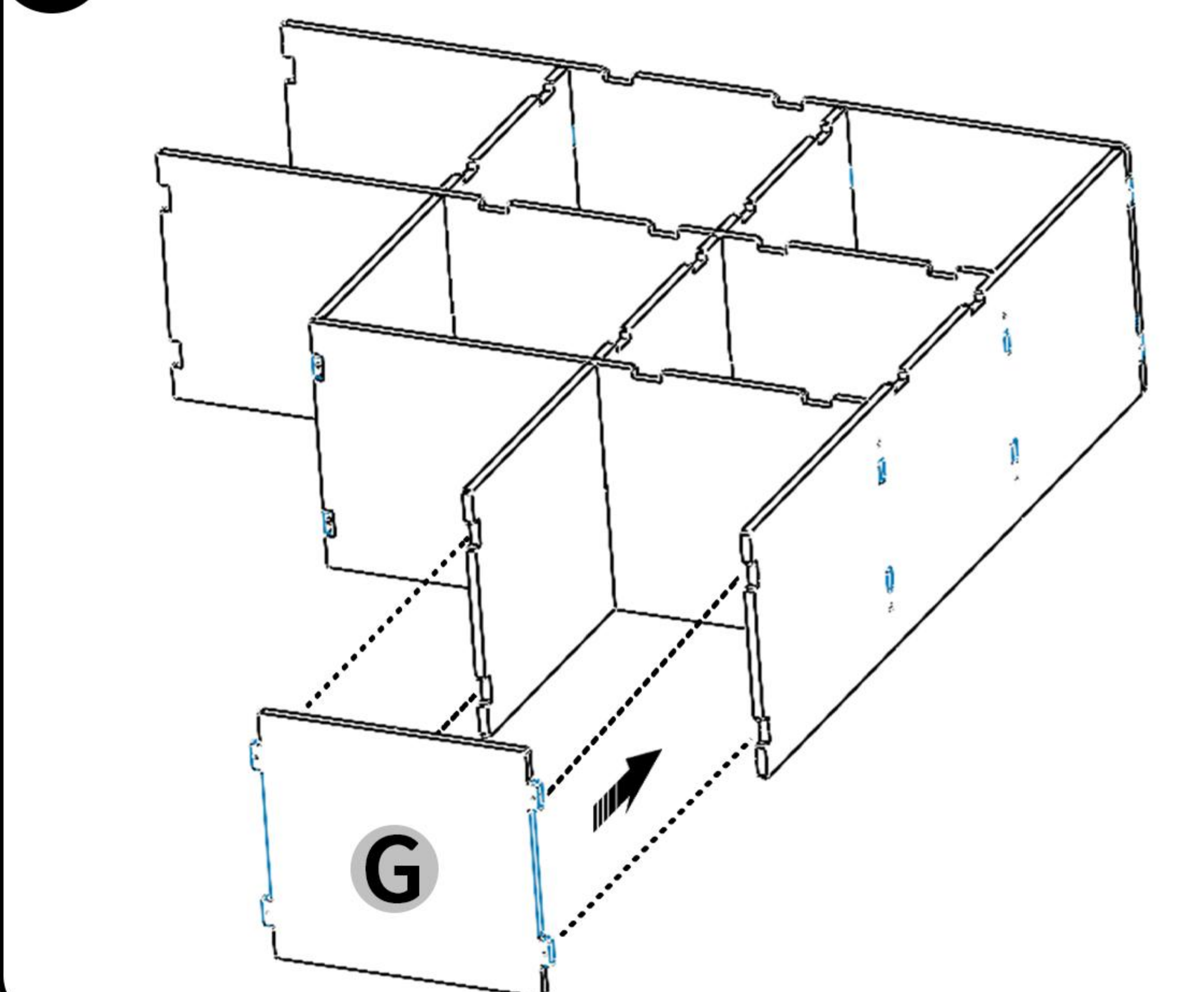

07 + G₂

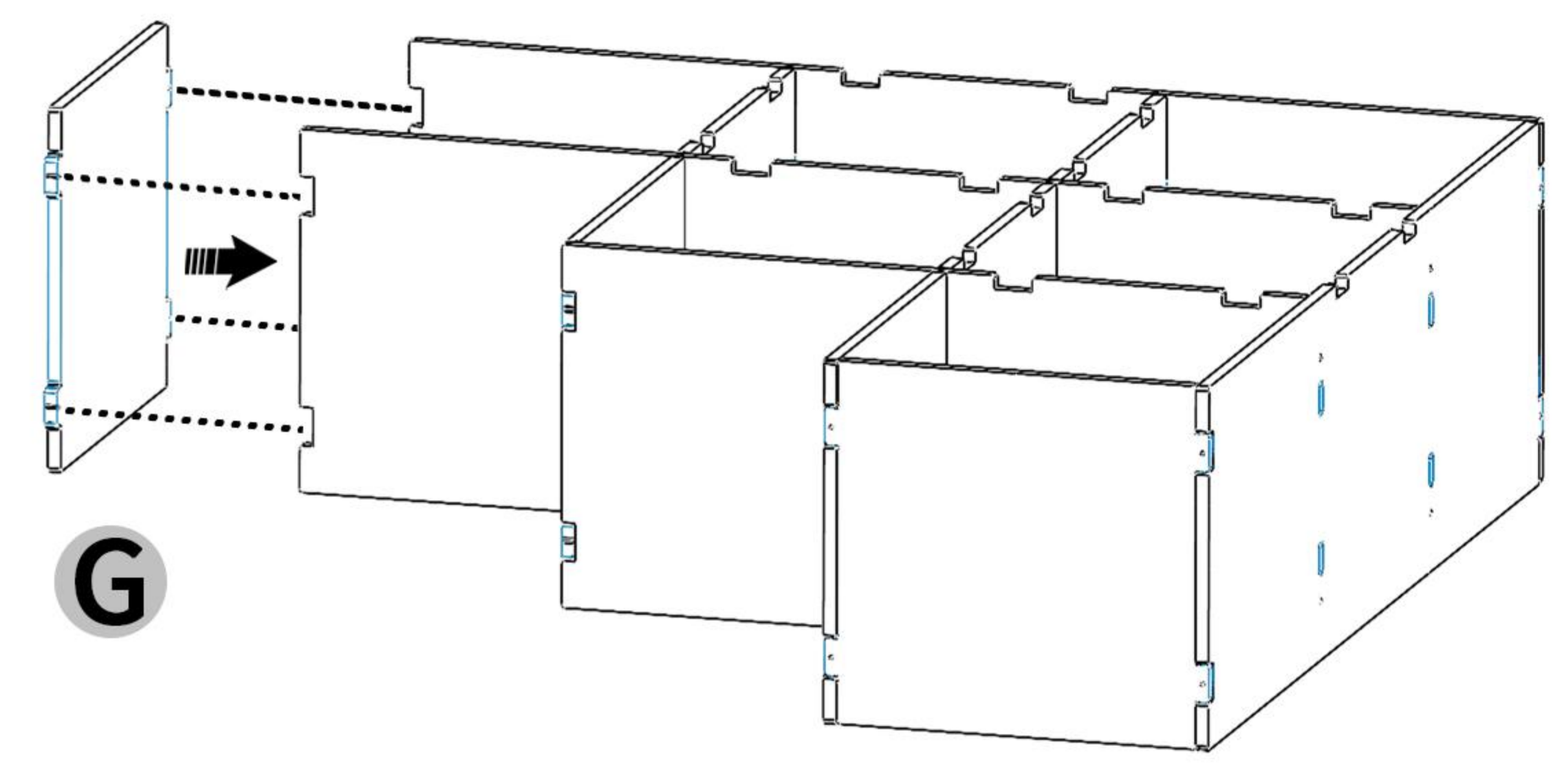

08 + H₁

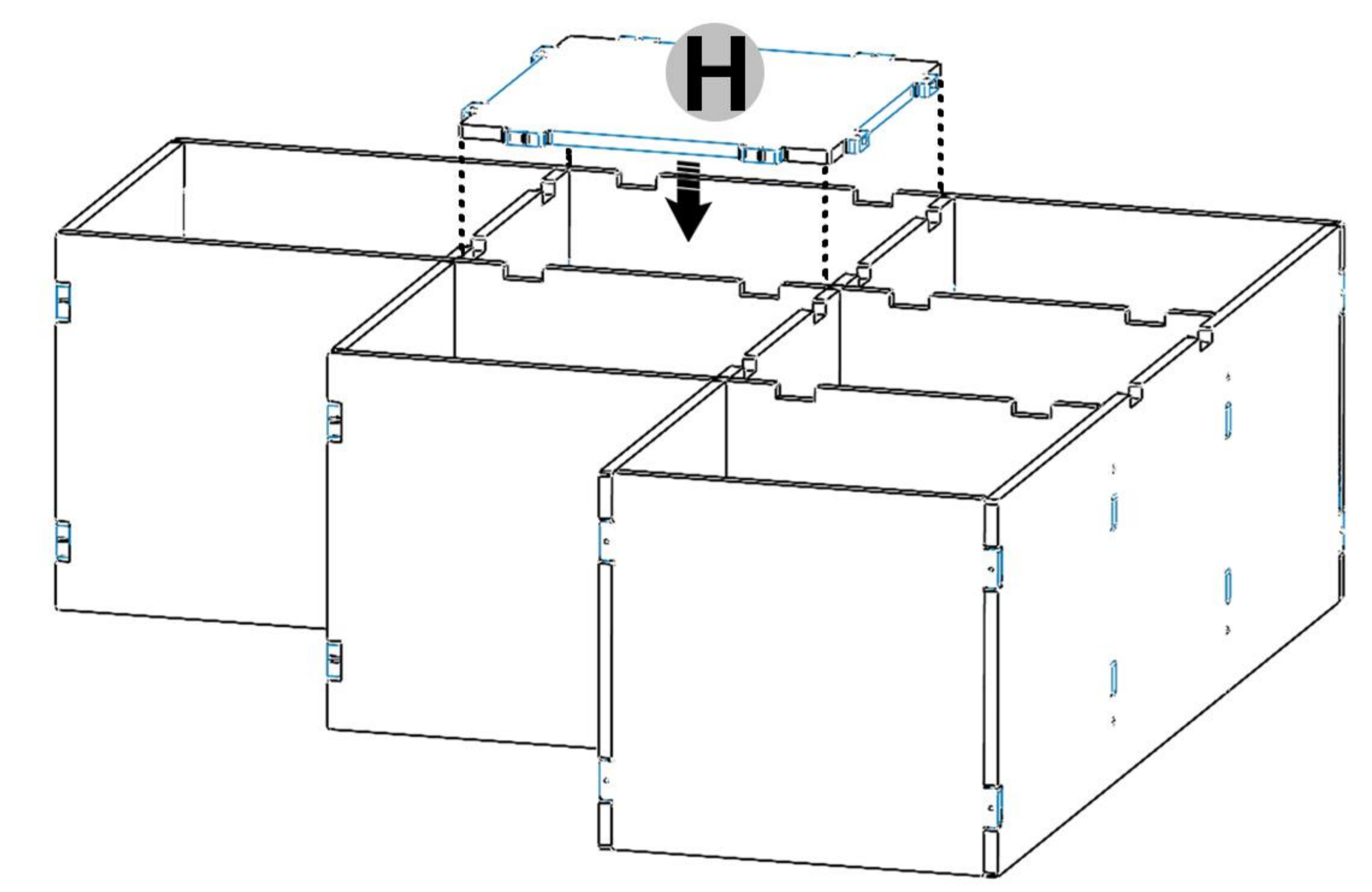

09 + H₂

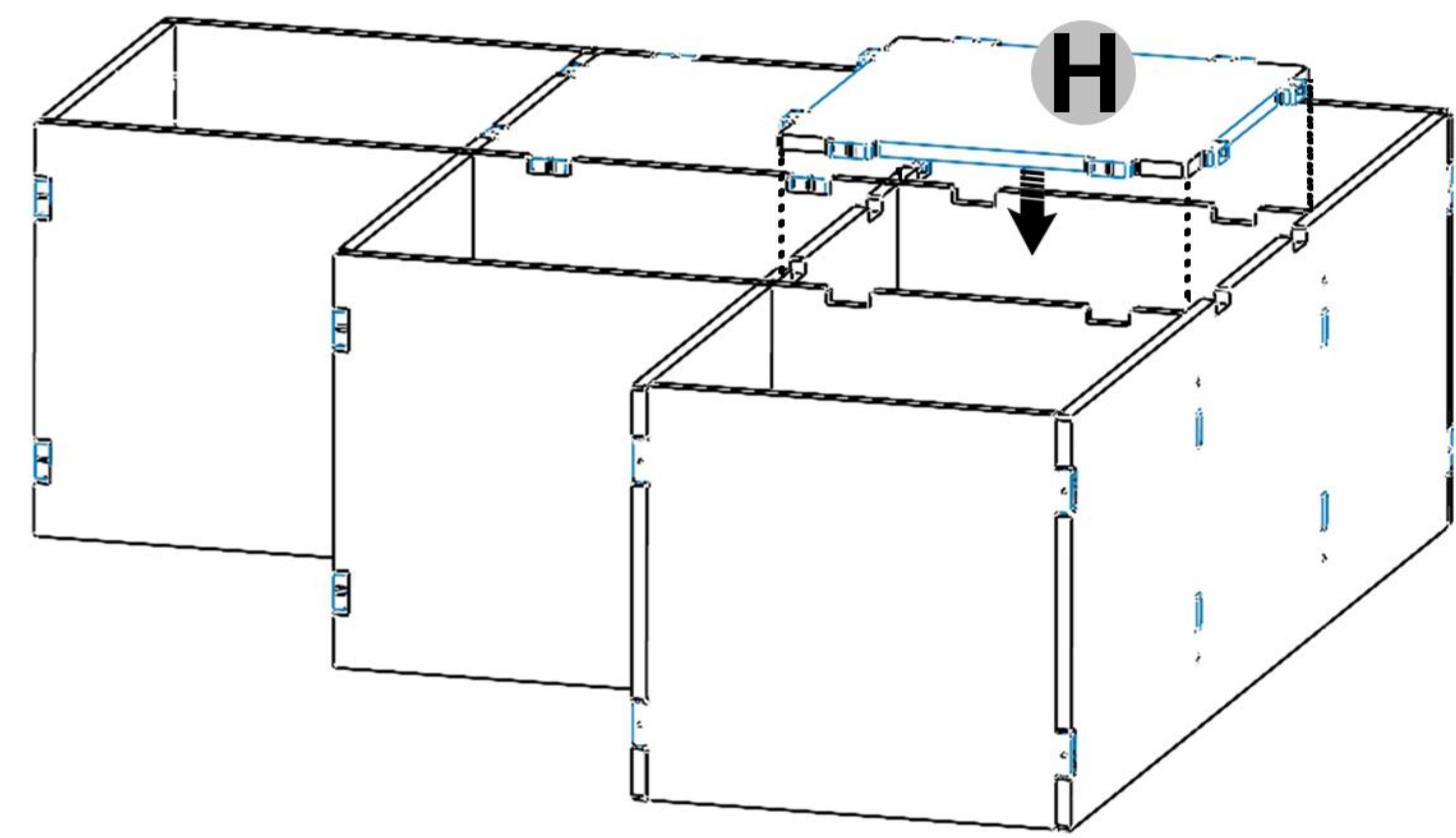

10 3.5 * 25 SCREWS X 26

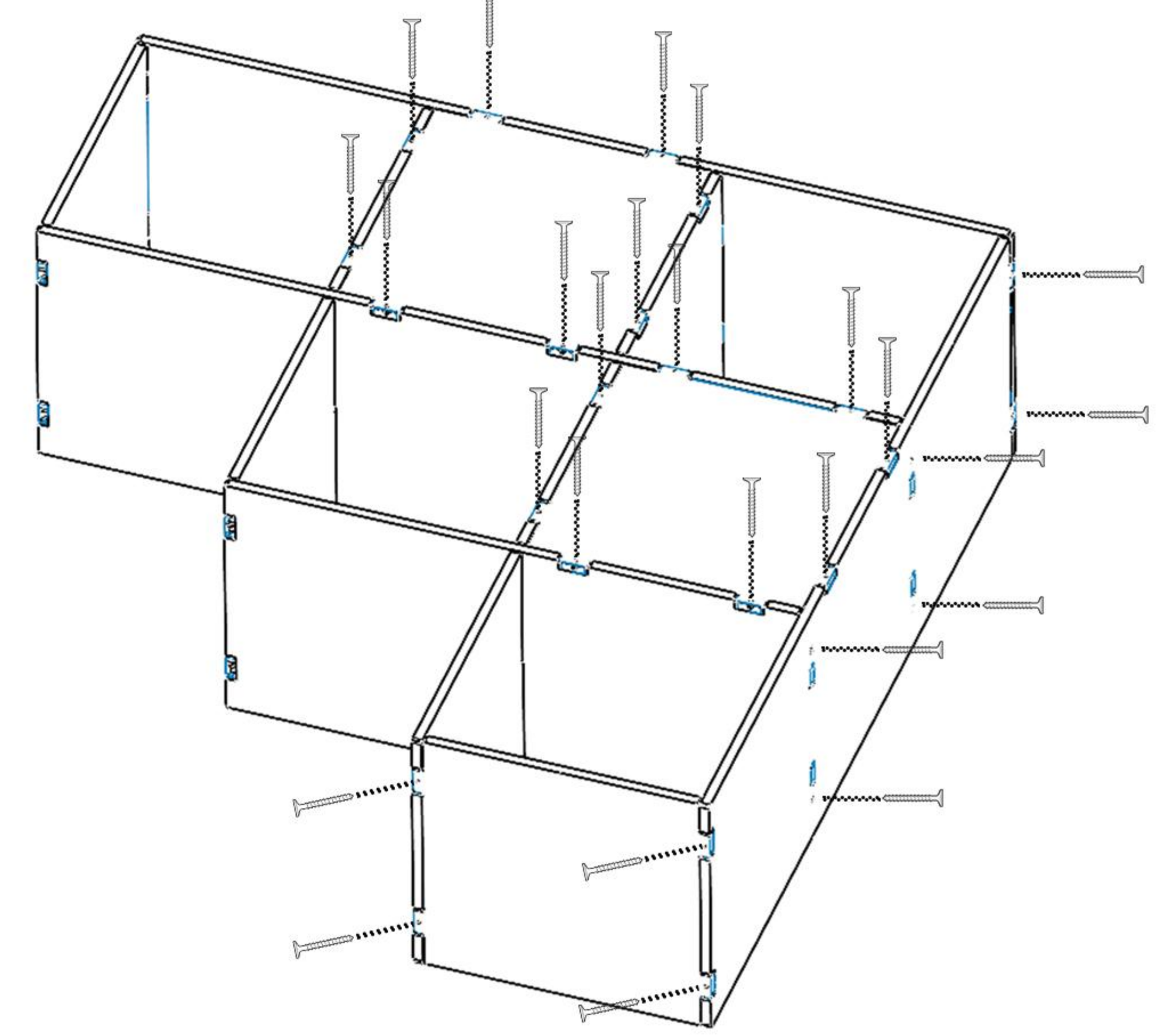

11 3.5*25 SCREWS X 10

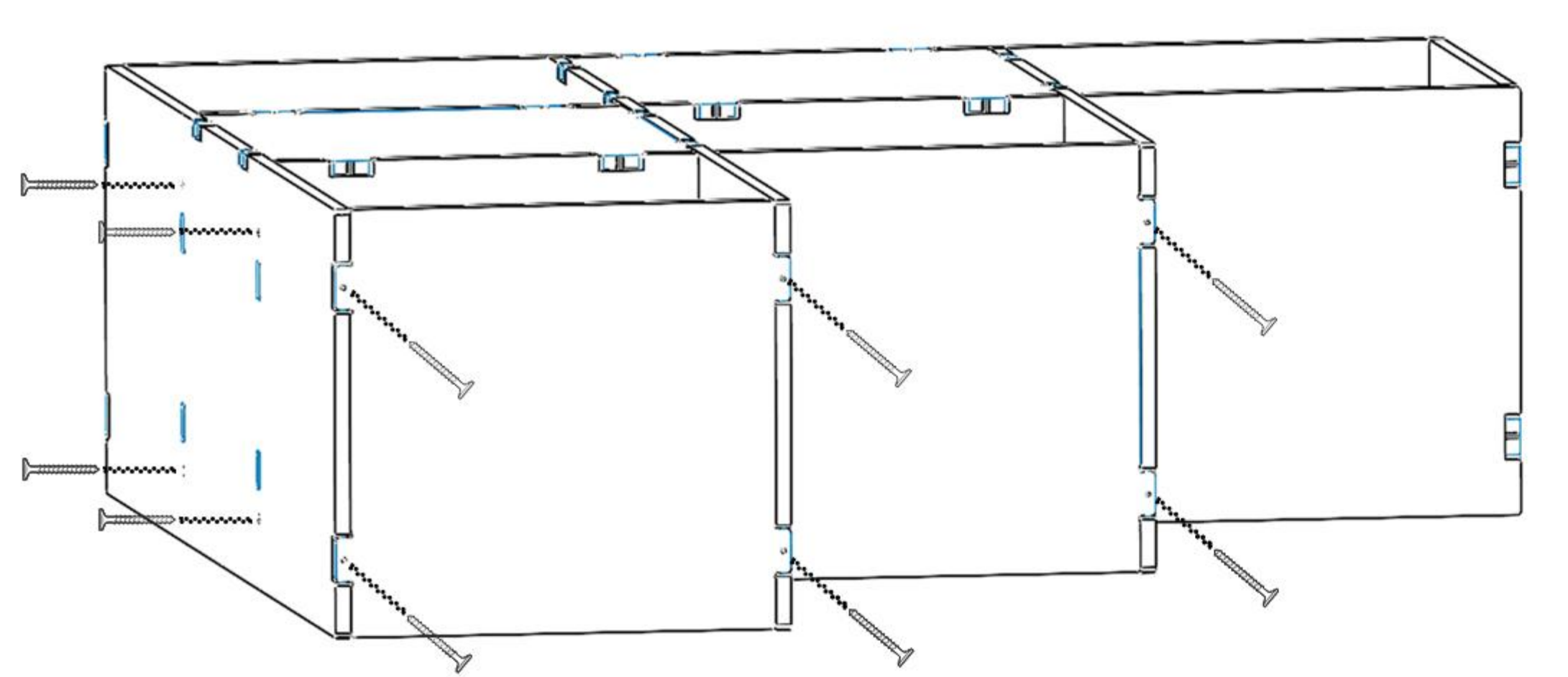

12 NON-SLIP MAT X 6

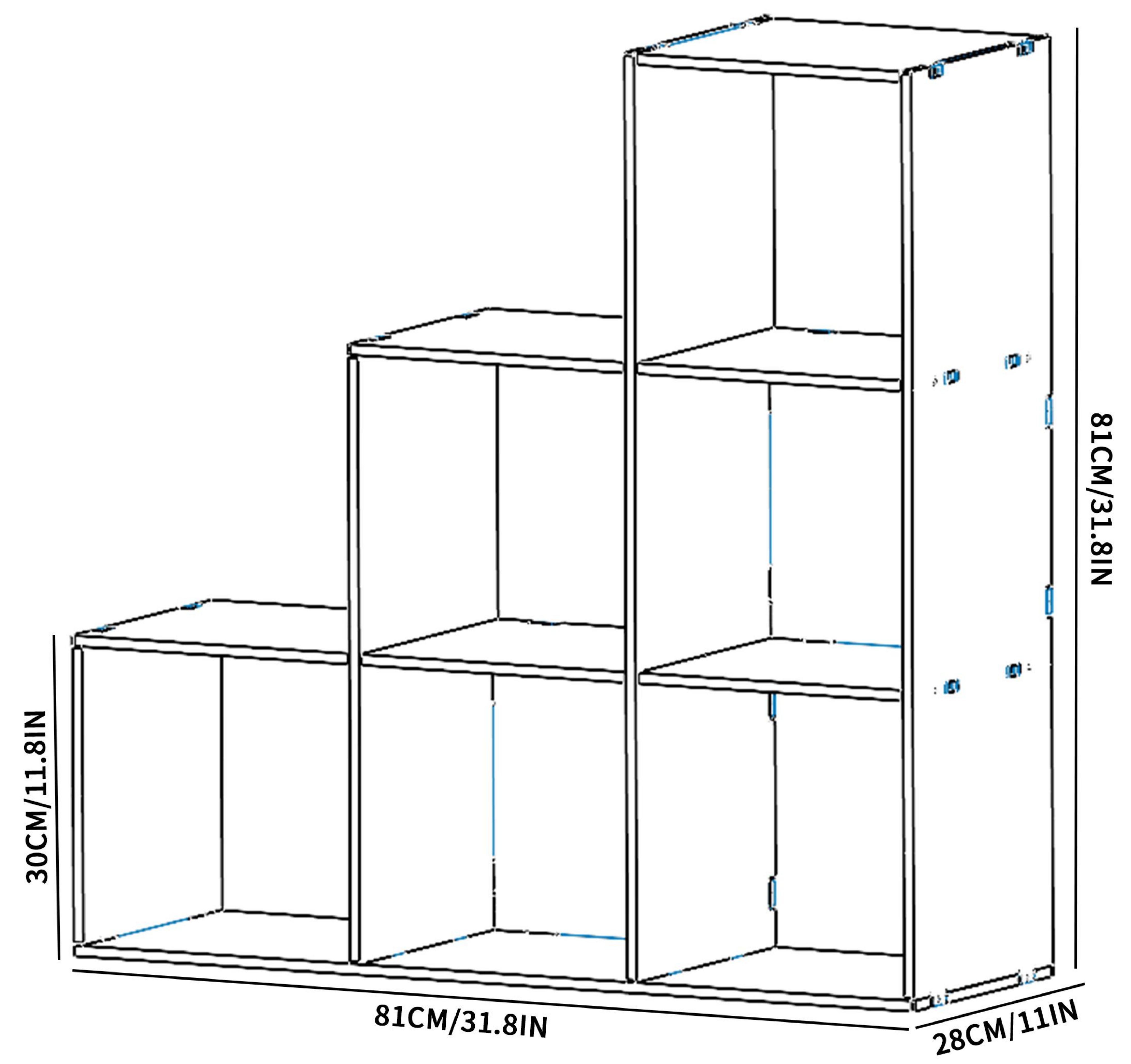
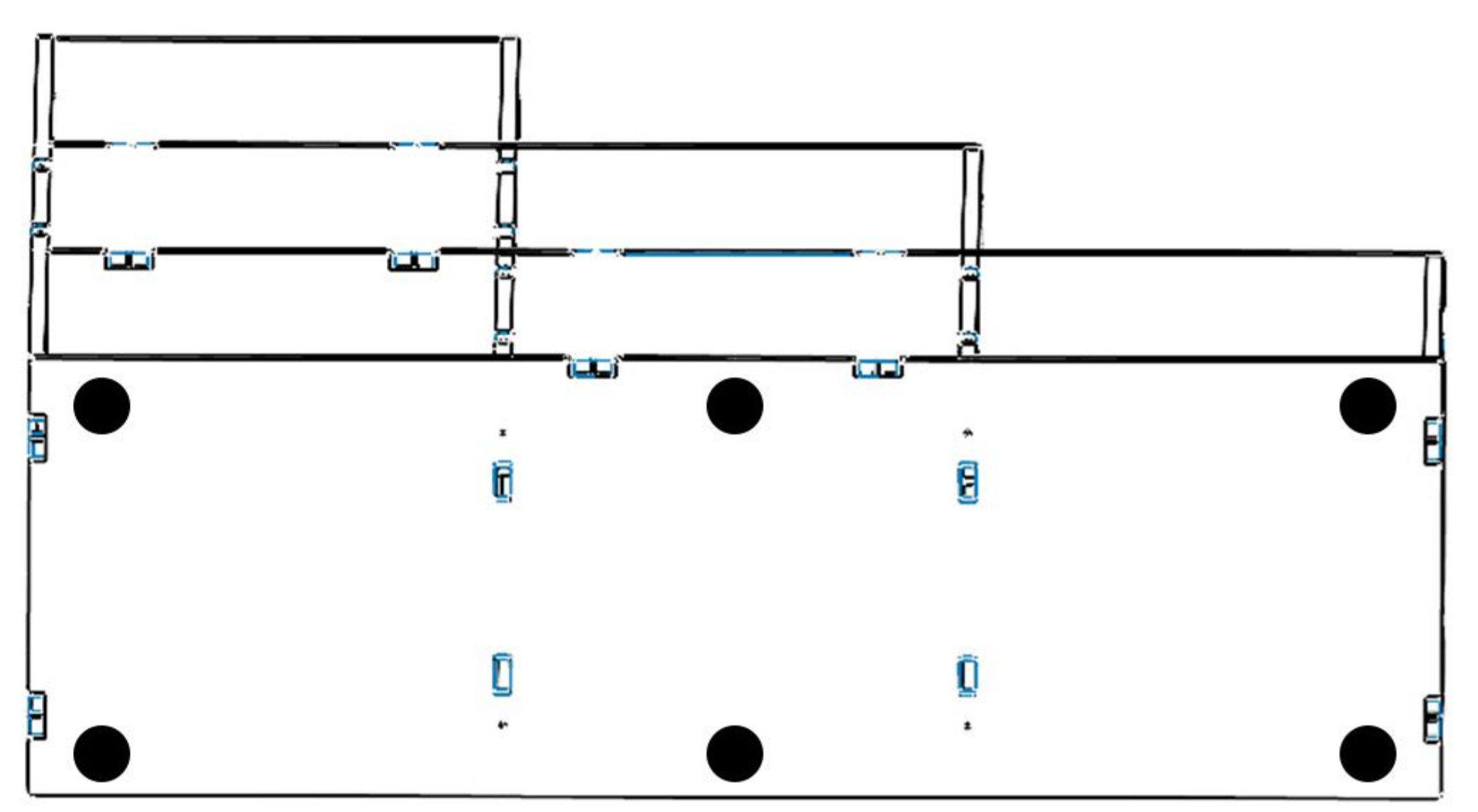

UNIT: CM/IN
(THE ERROR OF MANUAL MEASUREMENT IS ABOUT 0.5 CM)