

# Dining Chair

## Assembly Guide

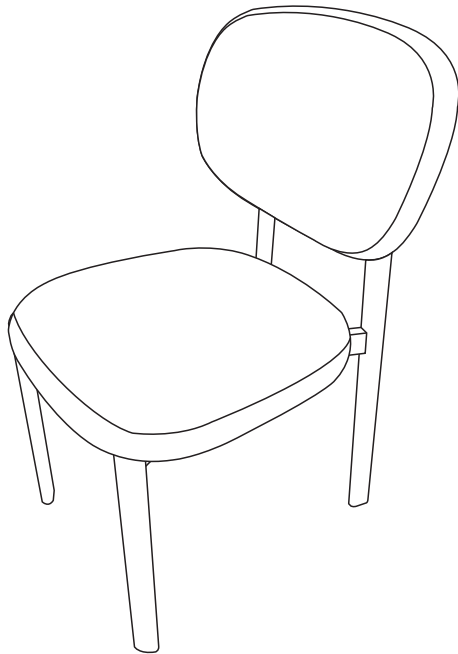

**IMPORTANT:** please read these instructions fully before starting assembly



**SAFETY AND  
CARE ADVICE**



**NO POWER TOOLS**

- Check you have all the components and tools listed
- Remove all fittings from their bags and separate into groups
- We do not recommend use of power tools - this could damage the unit. Only use hand screwdrivers and Allen keys
- Keep children and animals away from the work area, small parts could cause choking if swallowed
- Make sure you have enough space to lay out the parts before starting
- Assemble the item as close to its final position (same room) as possible
- Do not over tighten the nuts to avoid damage to the threads
- Only clean using a damp cloth and mild detergent. Do not use bleach or abrasive cleaners
- From time to time, check there are no loose screws in this unit
- This product should not be discarded with household waste. Take to your local authority waste disposal centre
- Unless otherwise stated, this product is designed for domestic use and is not certified for commercial or contract settings.

## IMPORTANT INFORMATION



20 Minute  
Build



Two Person  
Build









Max Weight  
Capacity  
120kg

**Note:** Assembly estimates are approximate and can differ based on the specific environment and user experience.

## WHAT'S IN THE BOX

**Note:** the quantities are the correct amount to complete the assembly. In some cases more fixings may be supplied than are required.

Label	Part Name	Drawing	Quantity
1	Rear leg		1
2	Front leg		1
3	Chair Seat		1

Label	Hardware Description	Drawing	Size (mm)	Quantity
A	Washer		M6 x 16	8
B	Screw		M6 x 40	2
C	Screw		M6 x 60	6
D	Allen Key		M5	1



**Note:**

- Use a clear, flat surface to avoid bumps or scratches before assembling.
- Insert all fixings loosely at first to allow for alignment; only tighten them once everything is properly positioned, as some adjustment may be required.
- Avoid over-tightening, as this may damage the parts.
- Seek assistance when moving large or heavy parts

## STEP 1

Carefully align the legs together and secure with 2x washers [A] followed by 2x screws [B] and loosely tighten with Allen key [D].



A		X2
B		X2
D		X1

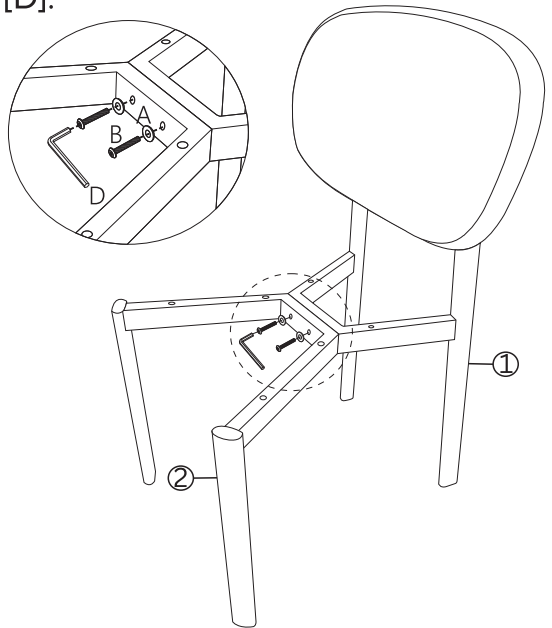



## STEP 2

Attach the chair seat [3] to the legs [1, 2]. You may find it easier using the edge of a table to assist. Align the pre-drilled holes and secure the chair seat using 1x washer [A] + 1x Screw [C] per hole (4 of each in total). Tighten with Allen key [D].

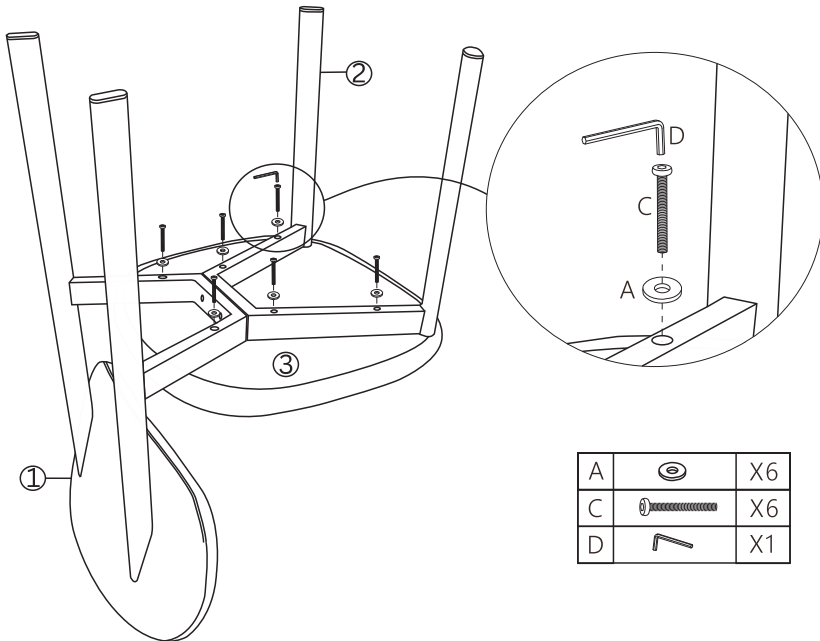
Fully tighten all screws [B] in step 1 and screws [C] in step 2.



A		X6
C		X6
D		X1

### **STEP 3**

Carefully, and with help, place the chair on its feet and check for stability.

Your new chair is ready to use!

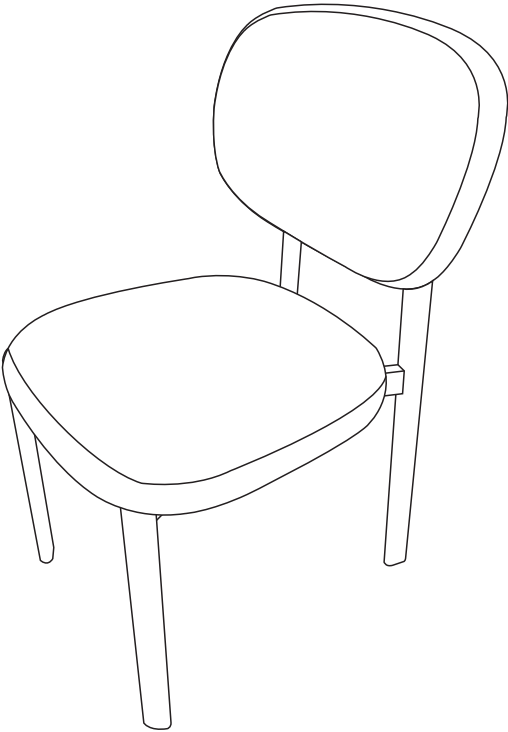

**Please ensure any and all fixings and fittings are FULLY tightened before using this product**



# our 2 year GUARANTEE

Our products come with a 2 year guarantee, giving you extra peace of mind when shopping with us!

## *What the guarantee covers*



**PRE-INSERTED FIXINGS**  
e.g. loose metal threads



**FAULTY JOINTS**  
e.g. legs bending



**EXTERNAL FIXING FAULTS**  
e.g. metal discs removing  
from table top



**STRUCTURAL INTEGRITY**  
e.g. the frame of the  
product