

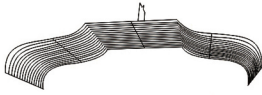

Please read these instructions and warranty information carefully before use and keep them properly for future reference.

OPERATING INSTRUCTIONS

Part List



A



B

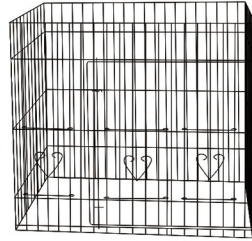

C

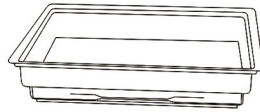

D



E 3Pcs



F 1Pc



K 2Pcs



G 4Pcs



I



H 4Pcs



J

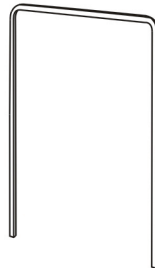

L 2Pcs



M 8Pcs



N 4Pcs



P

Assembly Instructions

STEP 1

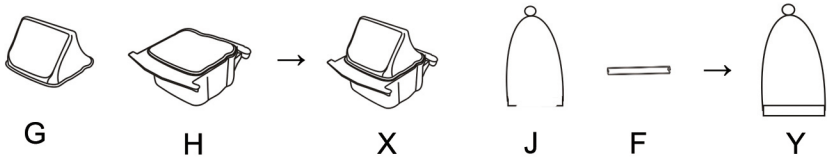

STEP 2

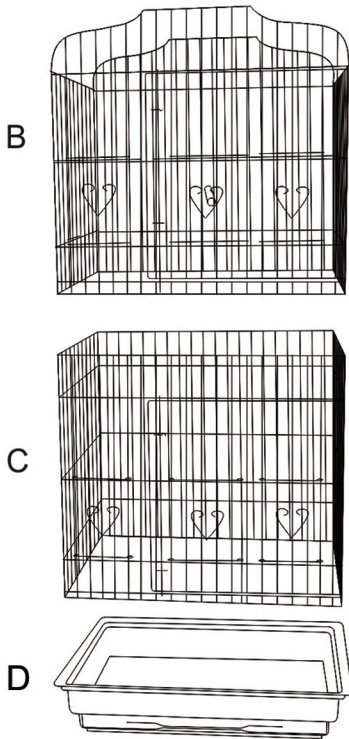

STEP 3

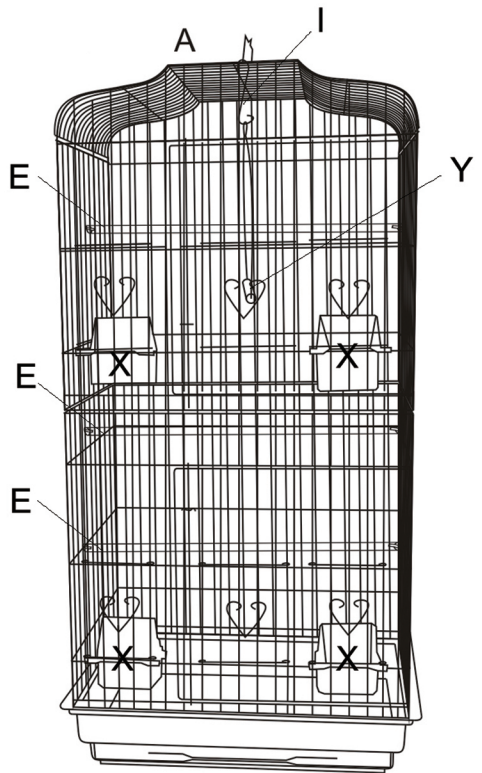

Assembly Instructions

STEP4

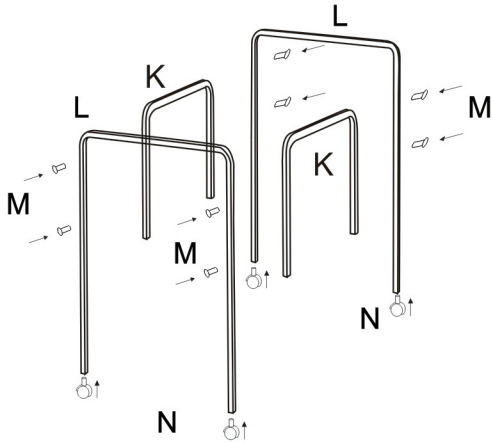

STEP6

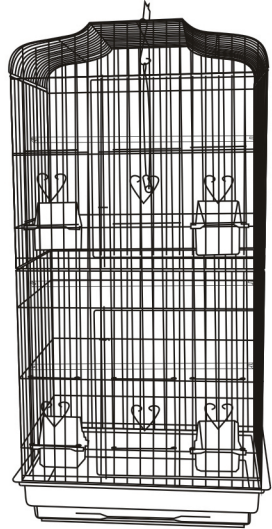

STEP5

