

5 PIECE OUTDOOR PATIO DINING SET

NOTE:
NO ASSEMBLY REQUIRED
FOR DINING ARM CHAIR

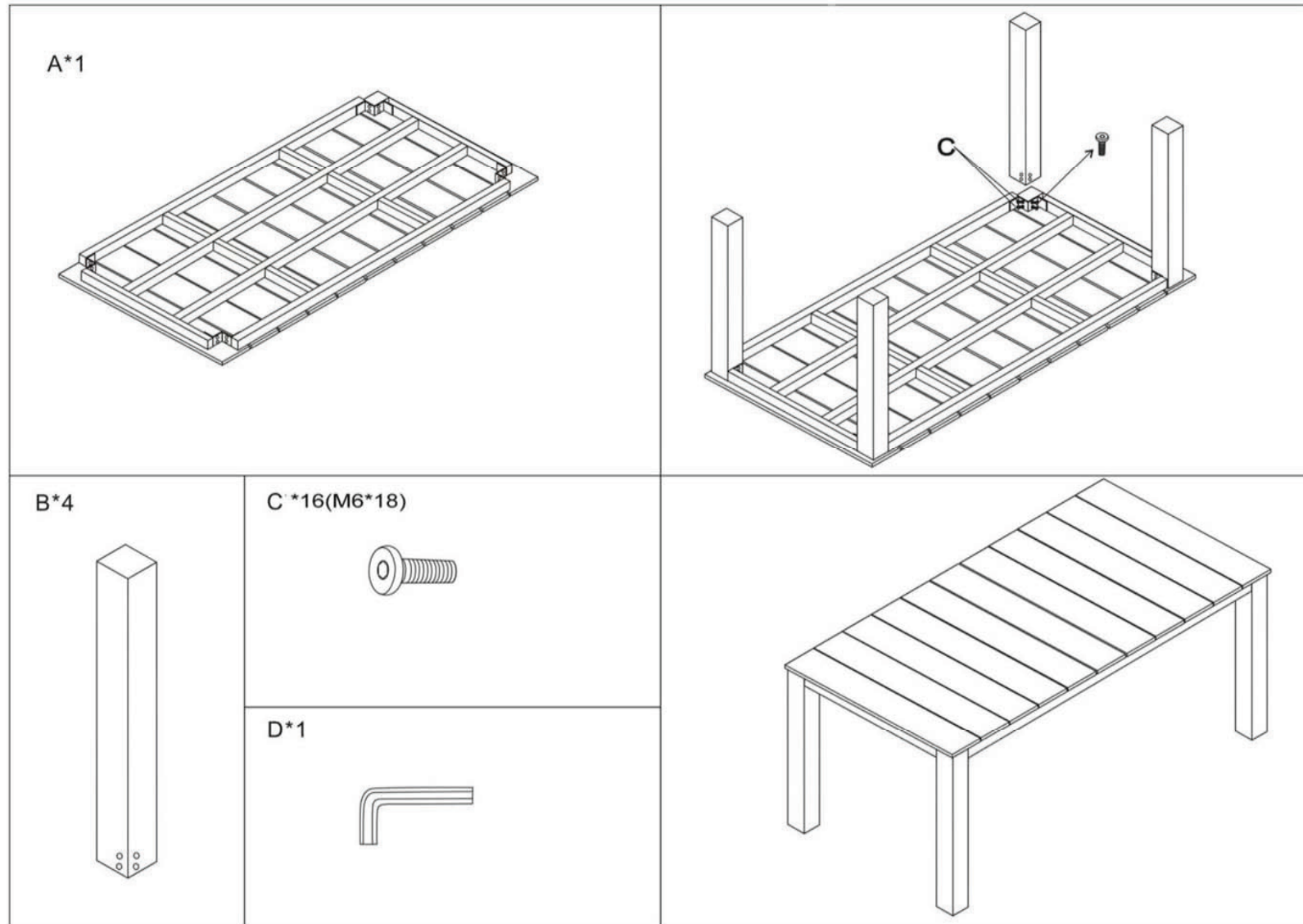

POLYWOOD TABLE CARE INSTRUCTION

Easy to clean with damp cloth. Use mild soap to wipe off the dust on the polywood and frame.

A glass can act as a convex lens and cause extreme heat locally. For that reason all heat-sensitive items should be put on a tablecloth or table mat.

When using a table-barbecue, charcoal sparks can cause melting dots locally, so be careful. Do not leave hot barbecue tongs and skewers on the table for the same reason.

Follow the wood grain with sand paper to remove any scratches or oily marks on the polywood. You can use the sand paper we provide.