



Assembly instructions for the chair, including warnings, time, and person requirements.

**Warning 1:** Do not use a power drill on the L-shaped metal bracket. 

**Warning 2:** Do not use a power drill on the rectangular metal plate. 

**Time:** 15' 

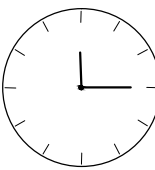
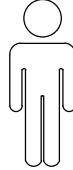
**Person:** 1 

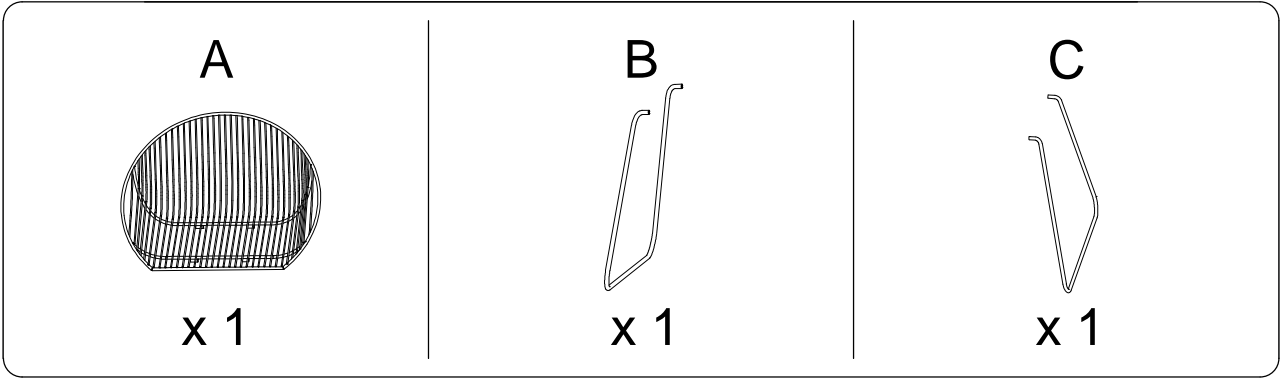

**A**

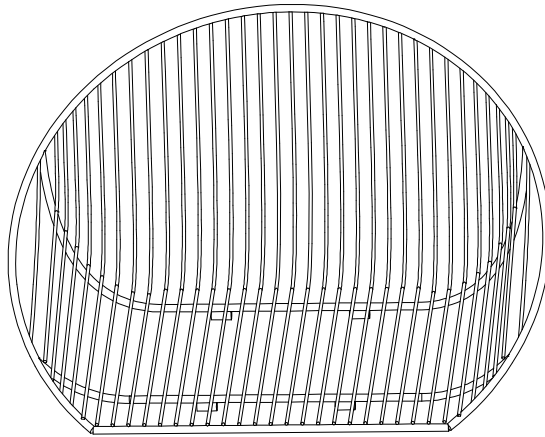



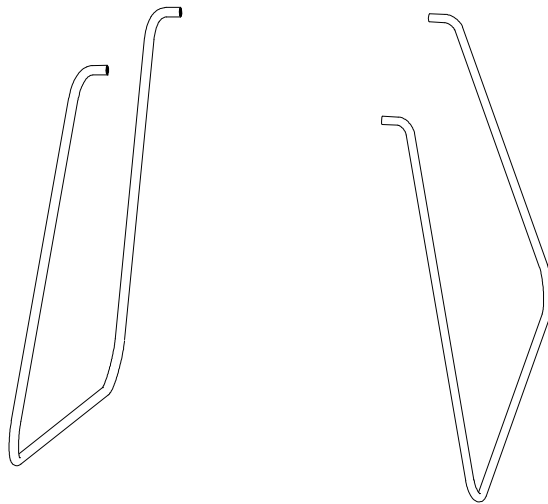

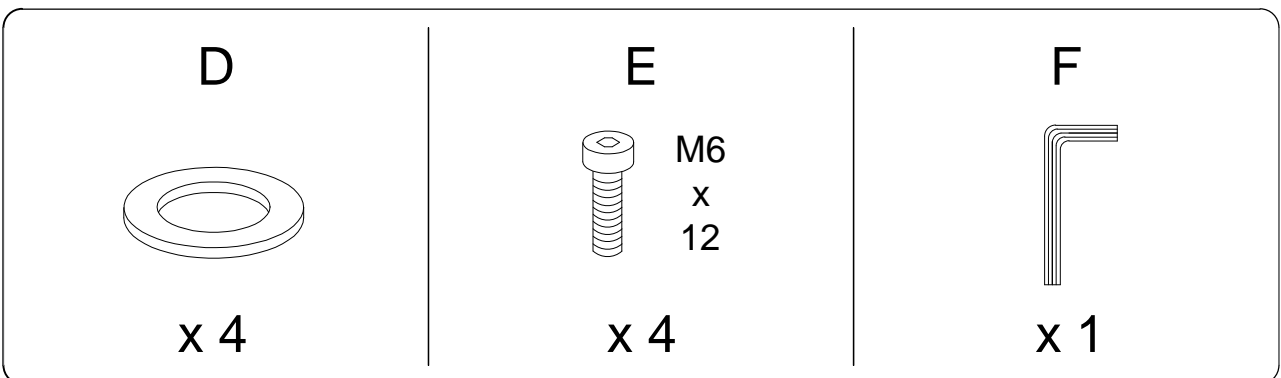

**B**



**C**



1

<b>A</b>  x 1	<b>B</b>  x 1	<b>C</b>  x 1	<b>D</b>  x 4	<b>E</b>  x 4	<b>F</b>  x 1
--	--	--	---	--	--

