











# Sink Base and Sink Base Vanity Instruction [Item: SB(33-48)]

## Hardware List

1	8 PCS	φ4*16mm	2	4 PCS	φ4*20mm	3	4 PCS	1-1/4	4	12 PCS	KC-A03	5	11 PCS	180°
Hinge screw			Large flat head hinge screw			DTC soft-closing hinge			Transparent self-adhesive rubber bumper			Bracket (Bow shape)		
														
6	11 PCS	90°	7	57 PCS	φ3.5*14mm	8	4 PCS	KC-A04	9	4 PCS	90°	10	24 PCS	φ3.5*14mm
Bracket (L-shaped)			Bracket Screw			Iron Triangle			Angle Bracket			Iron Triangle and Angle Bracket Screw		
														

## ASSEMBLE INSTUCTIONS

- Step 1 INSTALL BRACKET(L-SHAPED) ONTO FACE FRAME.
- Step 2 ATTACH THE SIDE PANEL TO THE FACE FRAME.
- Step 3 CONNECT BOTTOM PANEL AND TOE KICK TO THE CABINET.
- Step 4 CONNECT BACK PANEL.
- Step 5 INSTALL DRAWER FACE
- Step 6 INSTALL DOORS.
- Step 7 CONGRATULATIONS ON COMPLETING THE INSTALLATION.

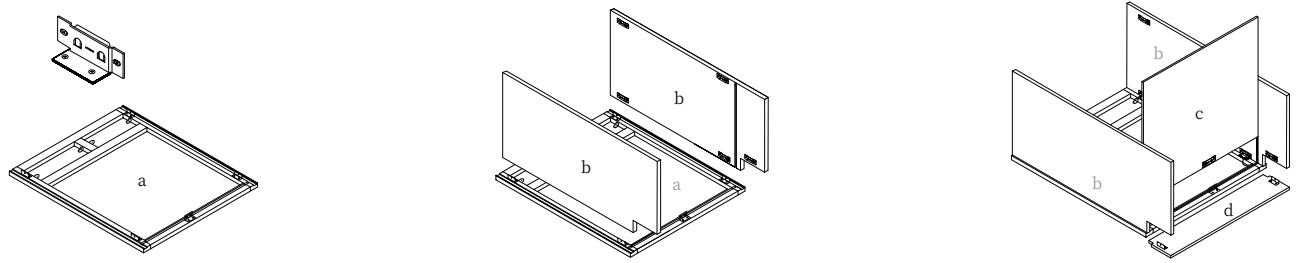

Step 1

Step 2

Step 3

## Description

a	FACE FRAME	1
b	SIDE PANEL	2
c	BOTTOM PANEL	3
d	TOE KICK	1
e	BACK PANEL	2
f	DRAWER FACE	2
g	DOOR	2

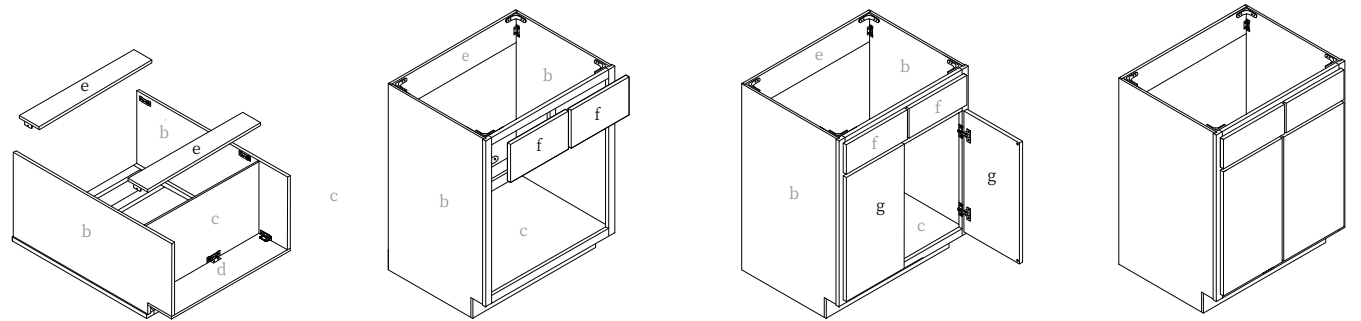

Step 4

Step 5

Step 6

Step 7