

ITEM NO. SCHD1643



Weight Limitation
150 LBS



Installation:
20 minutes.



One Person

Thank You For Choosing Our Furniture

- ▀ If you have any questions or concerns, don't hesitate to reach out to us. ▀

NOTE:





This brochure contains **IMPORTANT** safety info. Please read and keep it for future reference.

MAINTENANCE AND WARNINGS



Before You Start

Please follow the steps below:



-  Check the packaging for any damage, deformation, or water stains. If there is significant damage, please contact us promptly.
-  Unpack the box and compare the contents with the parts list and hardware list to ensure all components and accessories are present and complete.
-  Please read the installation instructions carefully to understand the installation steps and precautions to ensure proper installation.
-  Clean the installation area in advance and ensure the ground is level and there is enough space to avoid damaging the furniture or making installation difficult.
-  Lay a protective mat on the ground to prevent scratching the floor during installation.

After-Sales Service

- If you encounter any issues or need technical support during use, please contact our after-sales team. We offer long-term maintenance and warranty services.





Precautions

-  This product is for indoor use only. Do not expose it to outdoor elements or high-humidity environments.
-  Keep the product away from high heat or open flames to prevent fire hazards.
-  Do not allow children to climb on the product, as this may cause tipping and result in personal injury.



Safety Warnings

-  If you notice any loose or damaged parts, stop using the product immediately and contact customer service.
-  Do not attempt to disassemble or replace any components yourself, as this may affect the stability and safety of the product.





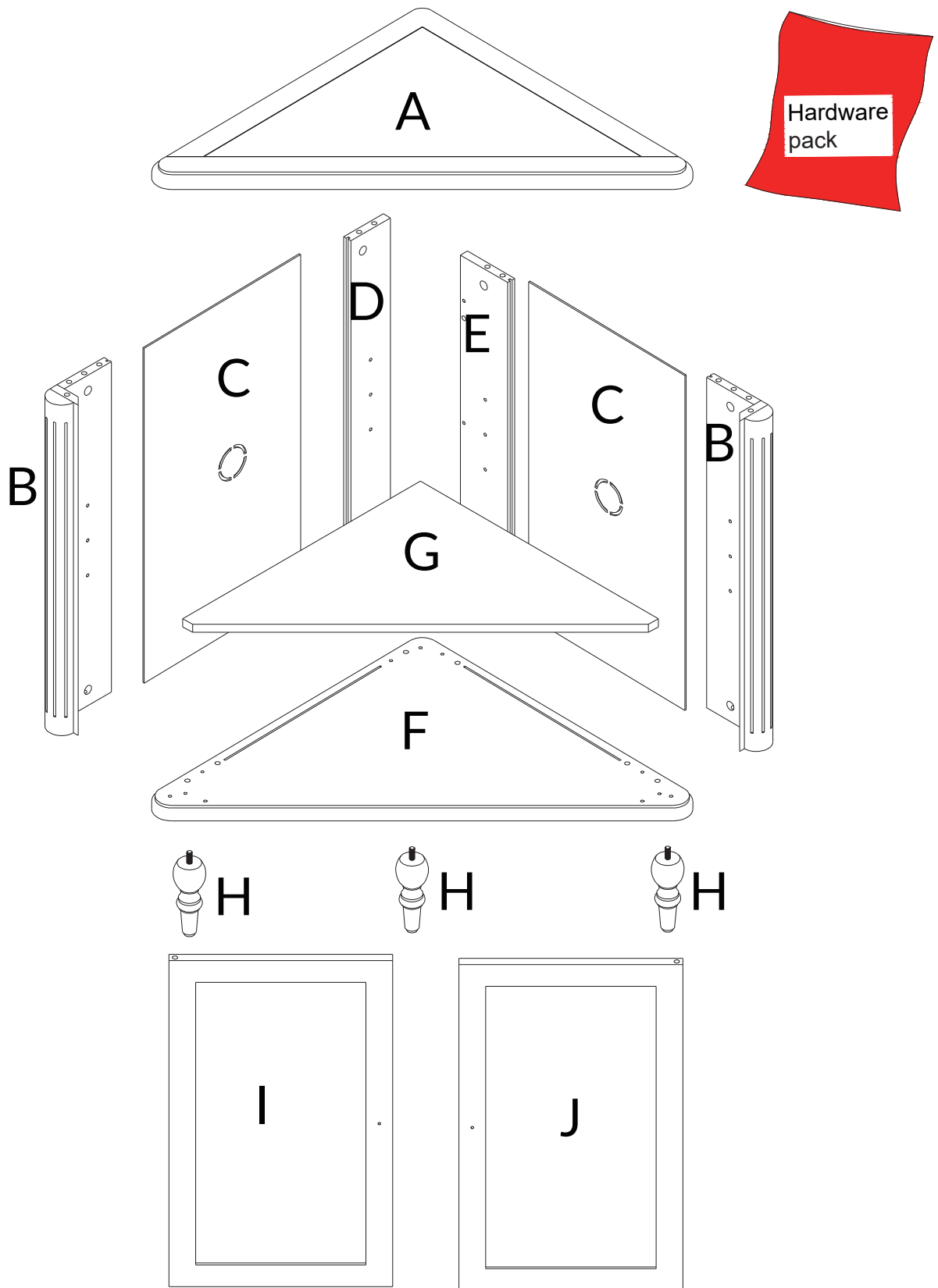

Daily Maintenance

- Regularly clean the surface with a soft cloth to prevent dust accumulation.
- Do not use cleaning agents containing acids, alkalis, or corrosive substances, as they may damage the surface. It is recommended to use neutral cleaning agents or specialized furniture cleaners.
- Avoid exposing furniture to humid environments for extended periods. Use a dehumidifier or desiccant during humid weather.
- Avoid direct contact of furniture with water. If water is accidentally spilled, wipe it dry immediately.
- Avoid placing excessively heavy objects on the furniture: ensure the weight is within a reasonable load-bearing range.
- Avoid using sharp or rough items on the furniture surface to prevent scratches. Handle items gently when moving them.

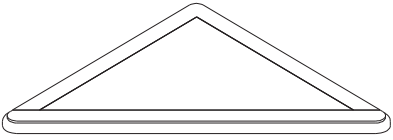

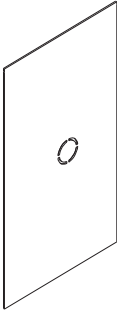
Explosive view

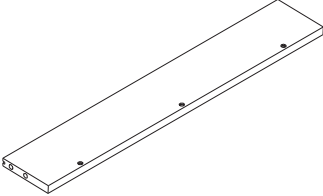
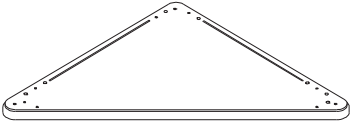
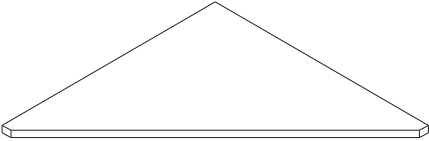

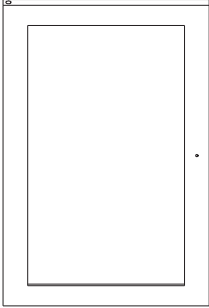
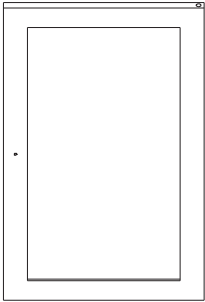
Parts list

<p>A x1 Panel</p> 	<p>B x2 Front side panel</p> 	<p>C x2 back panel</p> 
<p>D x1 Rear left panel</p> 	<p>E x1 Rear right panel</p> 	<p>F x1 Right side panel</p> 
<p>G x1 Shelf board</p> 	<p>H x3 Foots</p> 	<p>I x1 Door</p> 
<p>J x1 Door</p> 		

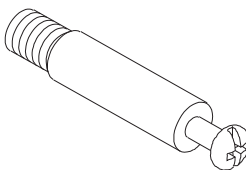
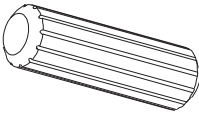
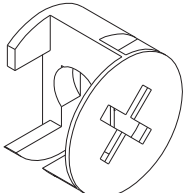
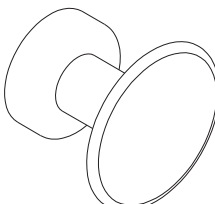
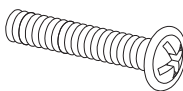
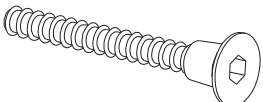
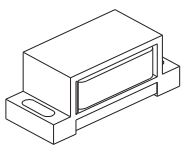
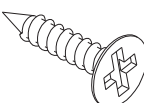
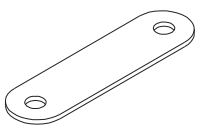
Hardware List

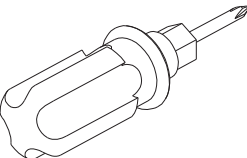
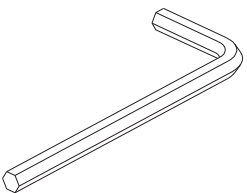
<p>① x12+2 three in one</p>  <p>M6x35mm</p>	<p>② x14+2 tree top</p>  <p>Ø8 x 30mm</p>	<p>③ x12+2 Eccentric wheel</p> 
<p>④ x2 Hold hands</p> 	<p>⑤ x2+1 Pull screw</p>  <p>M4x28mm</p>	<p>⑥ x3+1 Straight repair screws</p>  <p>Ø6.3x40</p>
<p>⑦ x2 doorstop</p> 	<p>⑧ x8+1 Self-tapping screw</p>  <p>M3x14mm</p>	<p>⑨ x2 Iron sheet</p> 
<p>⑩ x4+1 Layer board support</p> 	<p>⑪ x1 Screwdriver</p> 	<p>⑫ x1 Hex wrench</p>  <p>M4</p>

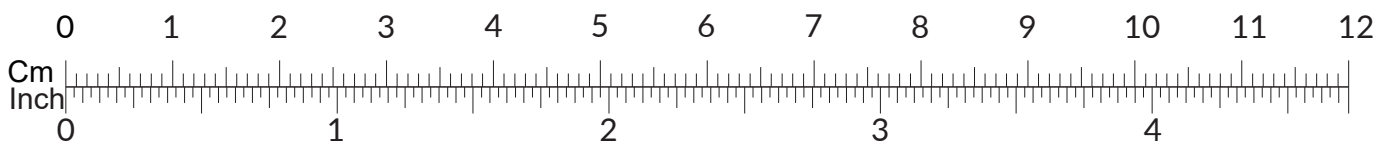

Note: Before installing the screws, please first distinguish the length of the screw rods.

Hardware List

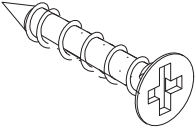
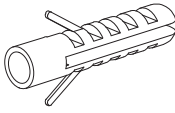
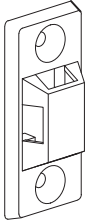
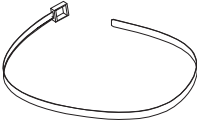
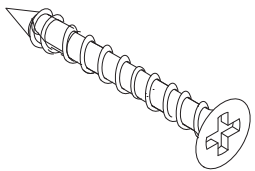
<p>13 x12+2 Masking tape</p>  <p>Ø21</p>	<p>14 x2+1 Self-tapping screw</p>  <p>M4 x 16mm</p>	<p>15 x2 Expansion pipe</p> 
<p>16 x2 Anti-tip component</p> 	<p>17 x1 Anti-tipping latch</p> 	<p>18 x2+1 Self-tapping screw</p>  <p>D4 x 40mm</p>

Step 1

Insert foot H into the corresponding hole on base plate F and tighten.

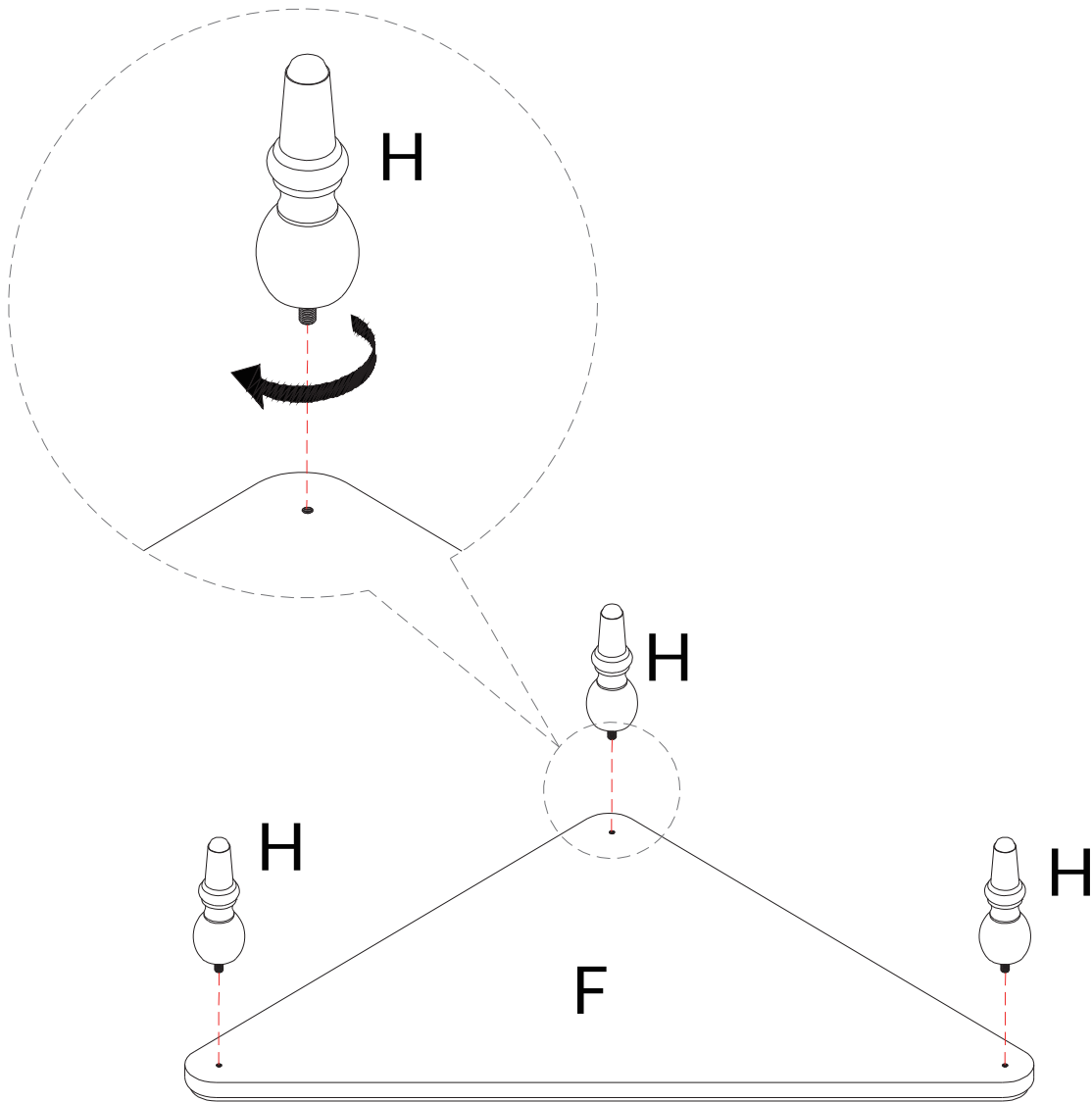

Step 2

Install the 3-in-1 module 1 into the corresponding hole of base plate F, and tighten it with screwdriver 11.

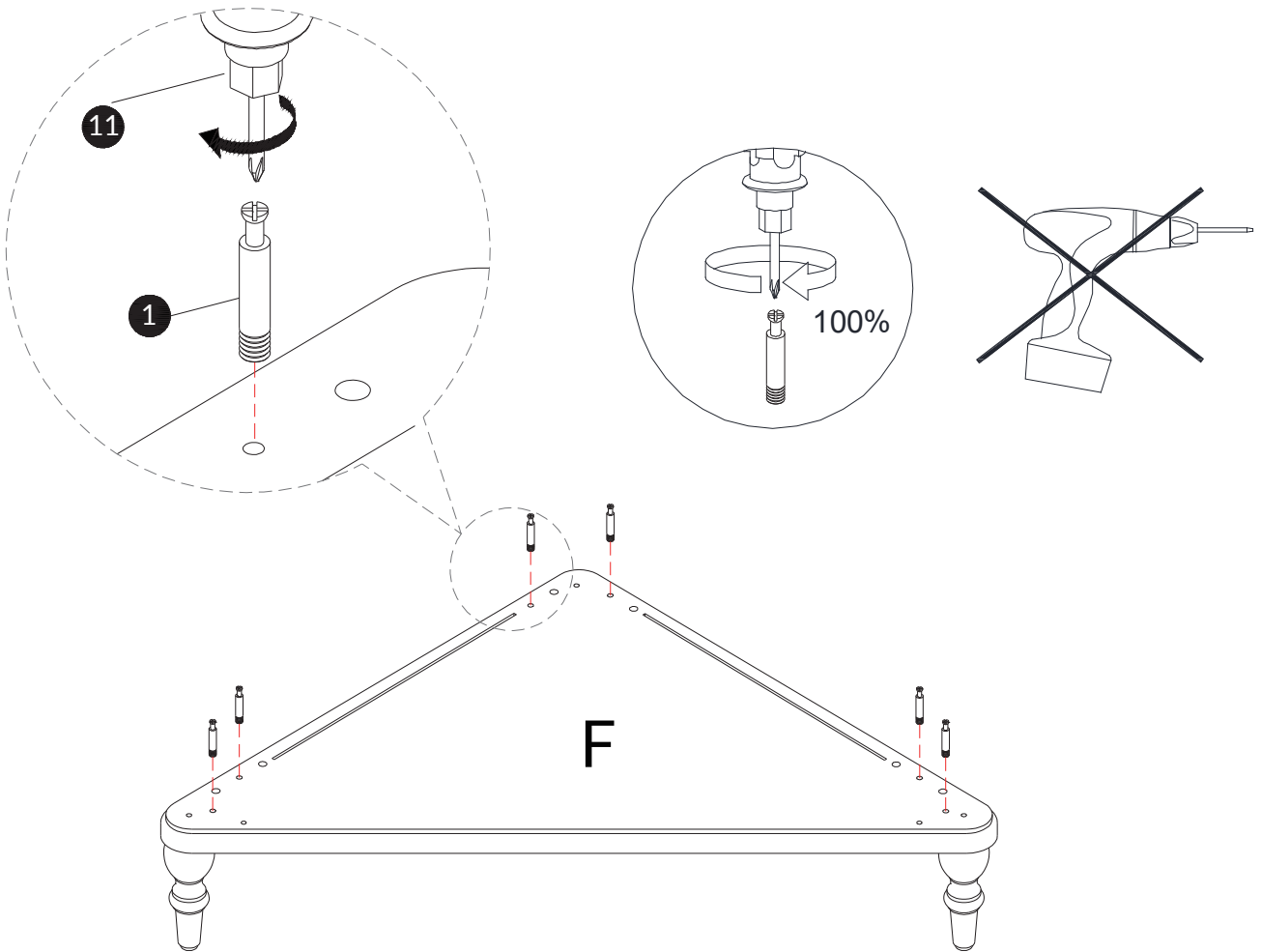

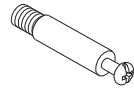
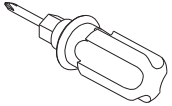

1 x6	11 x1
	
M6x35	

Step 3

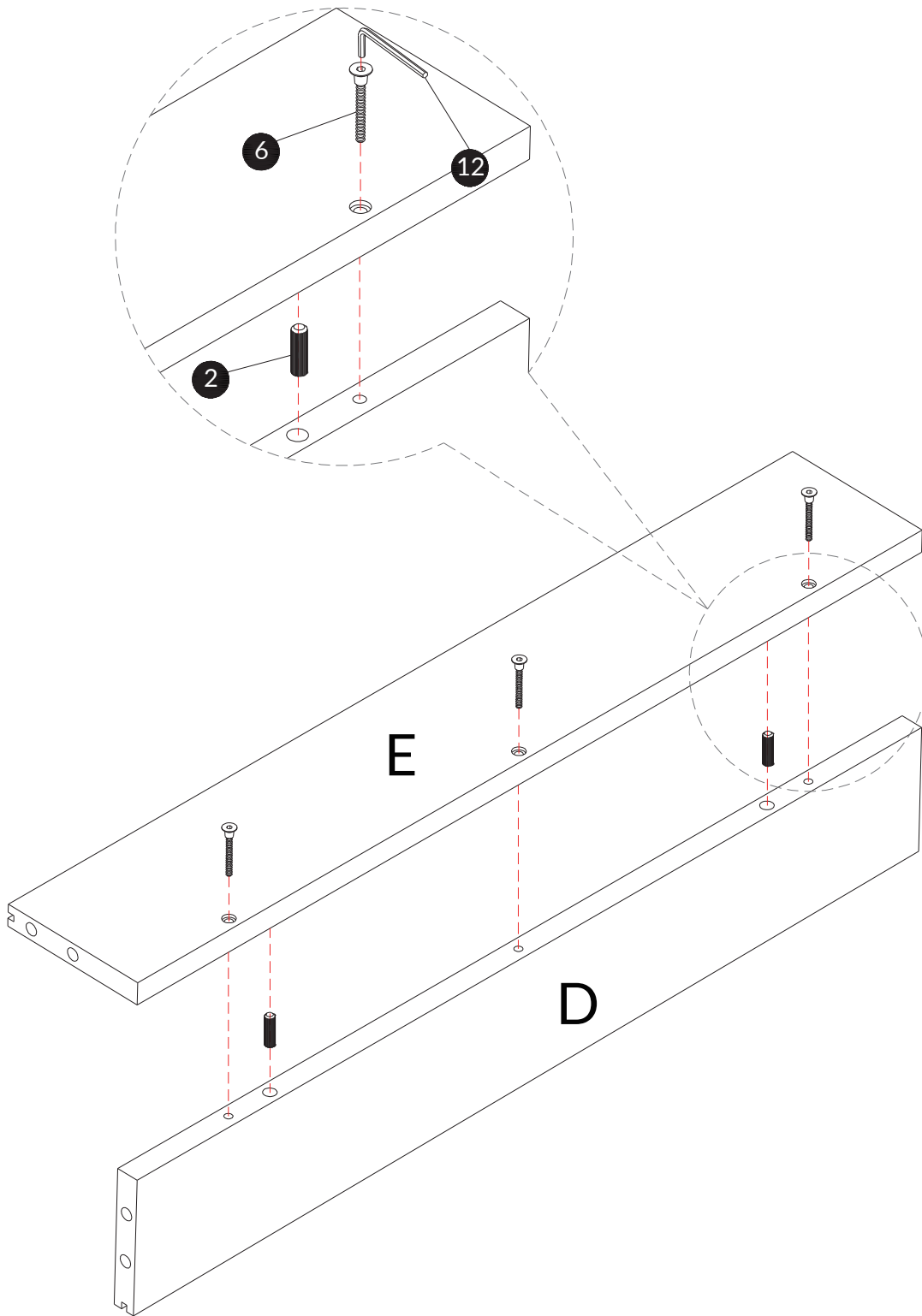
Insert the wooden tip 2 into the corresponding hole of the left upright D. Pass the screw 6 through the right upright E and insert it into the corresponding hole of the left upright D, then tighten it with wrench 12.

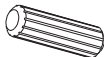

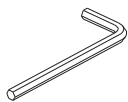



2 x2	6 x3	12 x1
		
Ø8x30mm	Ø6.3x40	

Step 4

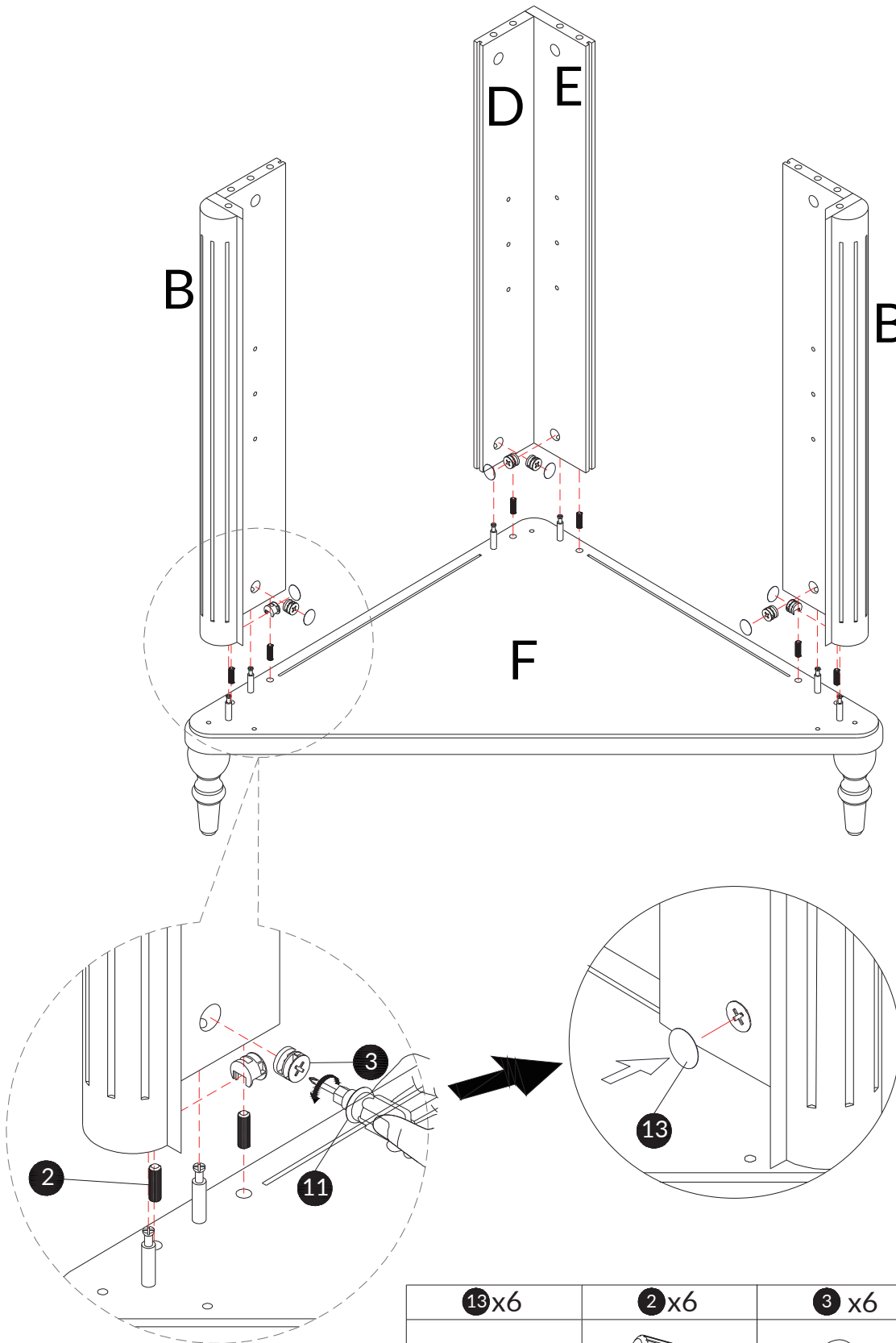
Insert wooden tip 2 into the corresponding hole of base plate F. Install eccentric wheel 3 into B/D/E, then install it into base plate F, and tighten with screwdriver 11.

Cover the eccentric wheel with 13 pieces of masking tape

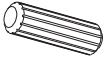

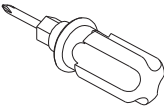
13x6	2x6	3x6	11x1
			
Ø 21	Ø8x30mm		

Step 5

Insert back panel C into the back panel slot. Insert shelf nails 10 into the corresponding holes of B/D/E.

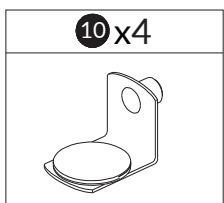
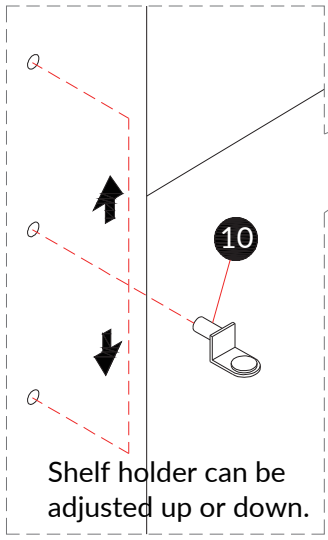
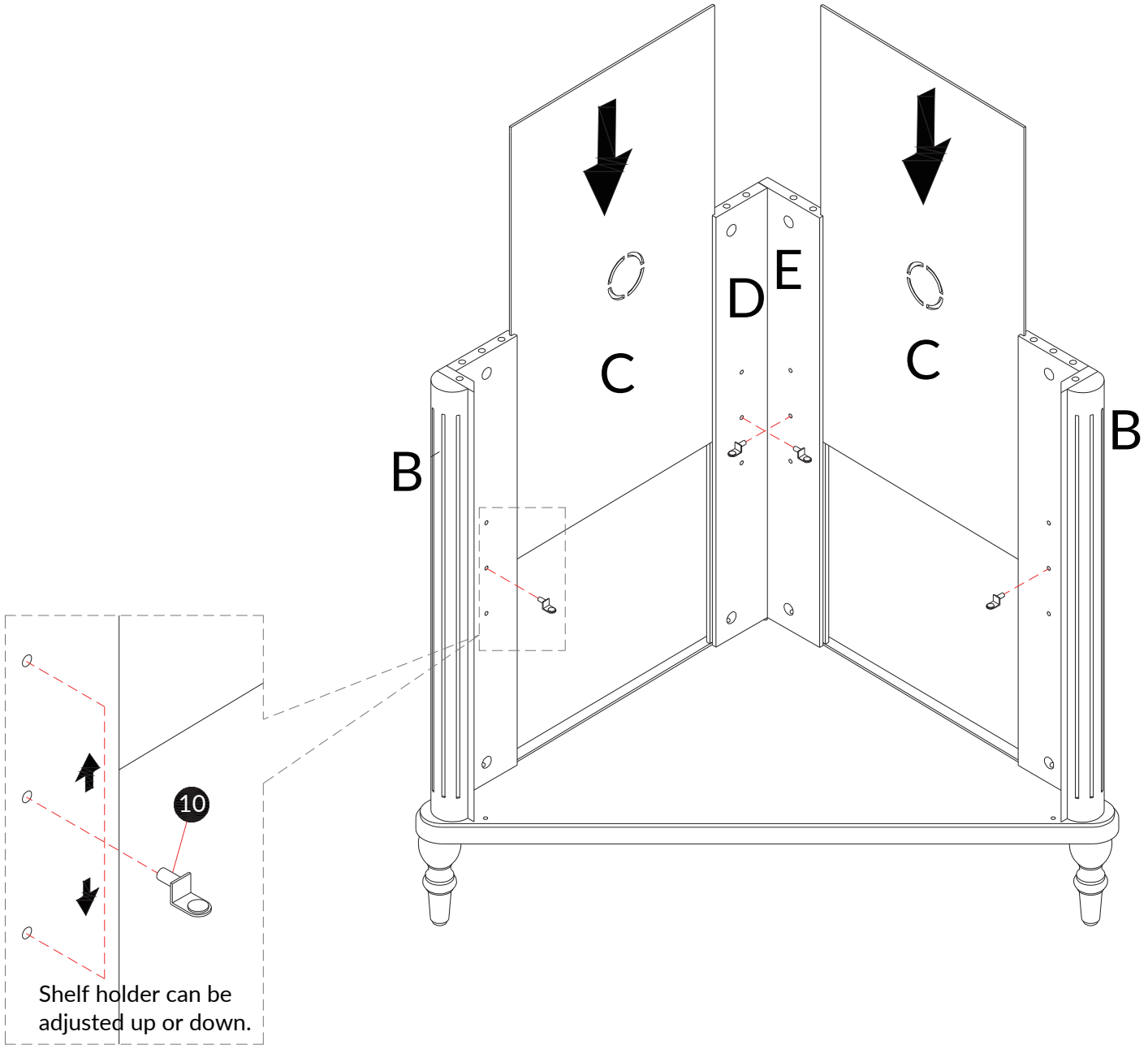

Step 6

Install the 3-in-1 component 1 into the corresponding hole on panel A and tighten it with screwdriver 11.
Insert screw 8 through the door stop 7 into the corresponding hole on panel A and tighten it with screwdriver 11.

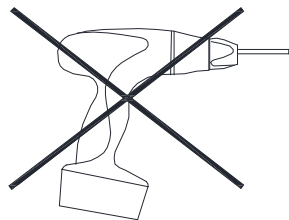
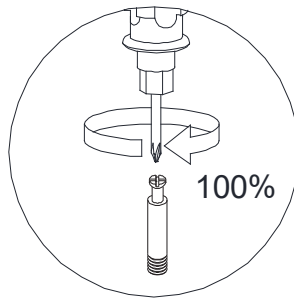
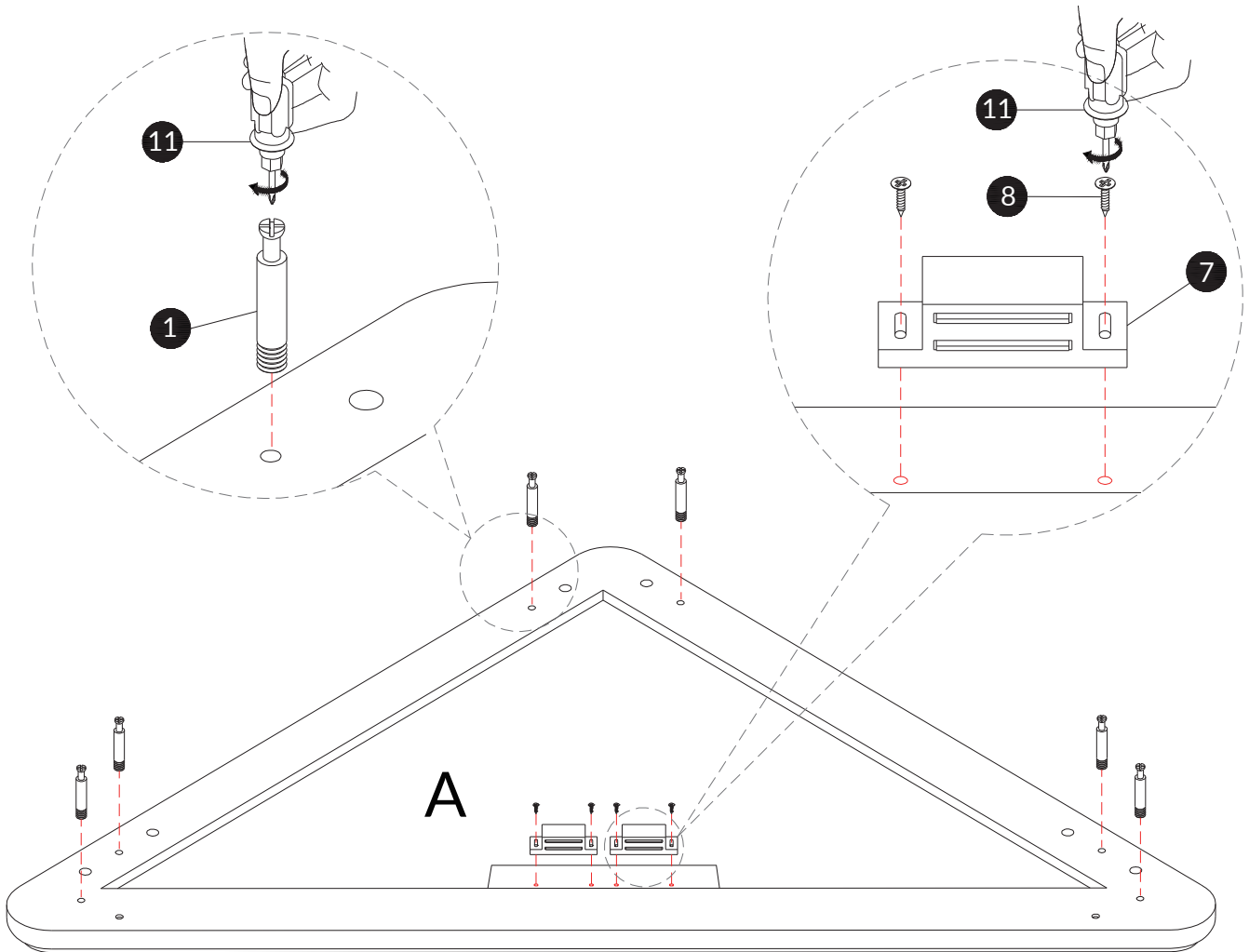

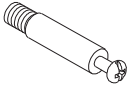
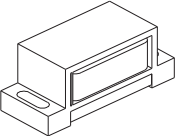
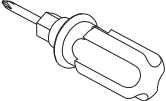
8 x4	1 x6	7 x2	11 x1
			
D3x14mm	M6x35		

Step 7

Insert the wooden tip 2 into the corresponding hole of B/D/E. Insert panel A into the corresponding hole of B/D/E, install the eccentric wheel 3, and tighten it with screwdriver 11. Cover the eccentric wheel with 13 pieces of masking tape

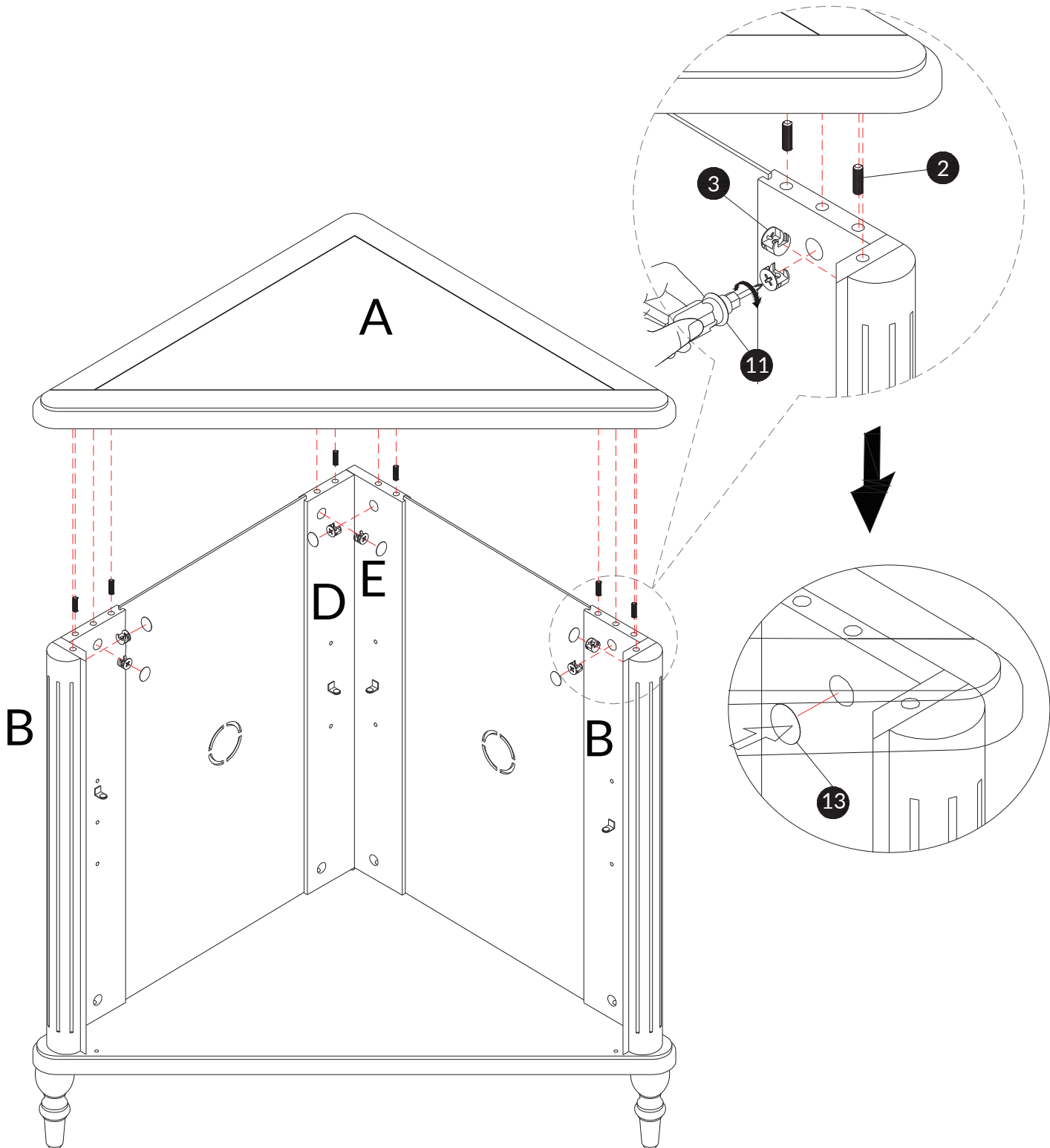

13x6	2 x6	3 x6	11x1
Ø21	Ø8x30mm		

Step 8

Place shelf G inside the cabinet and lay it flat.

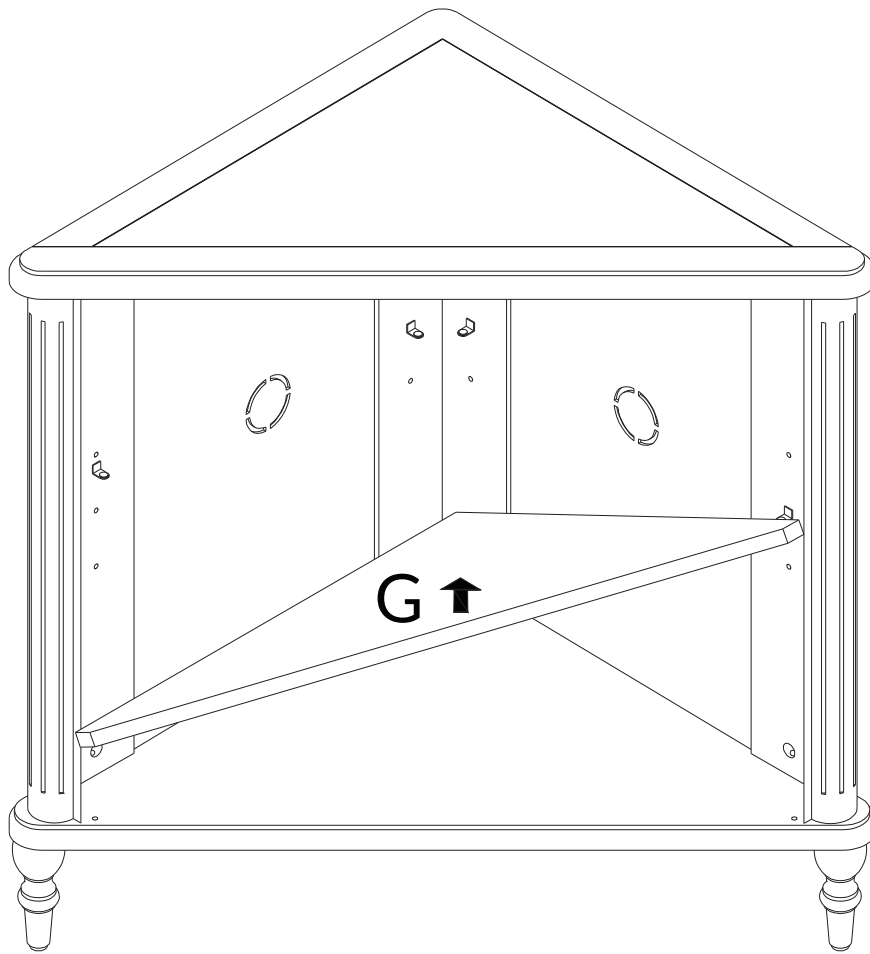

Step 9

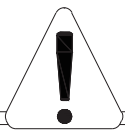
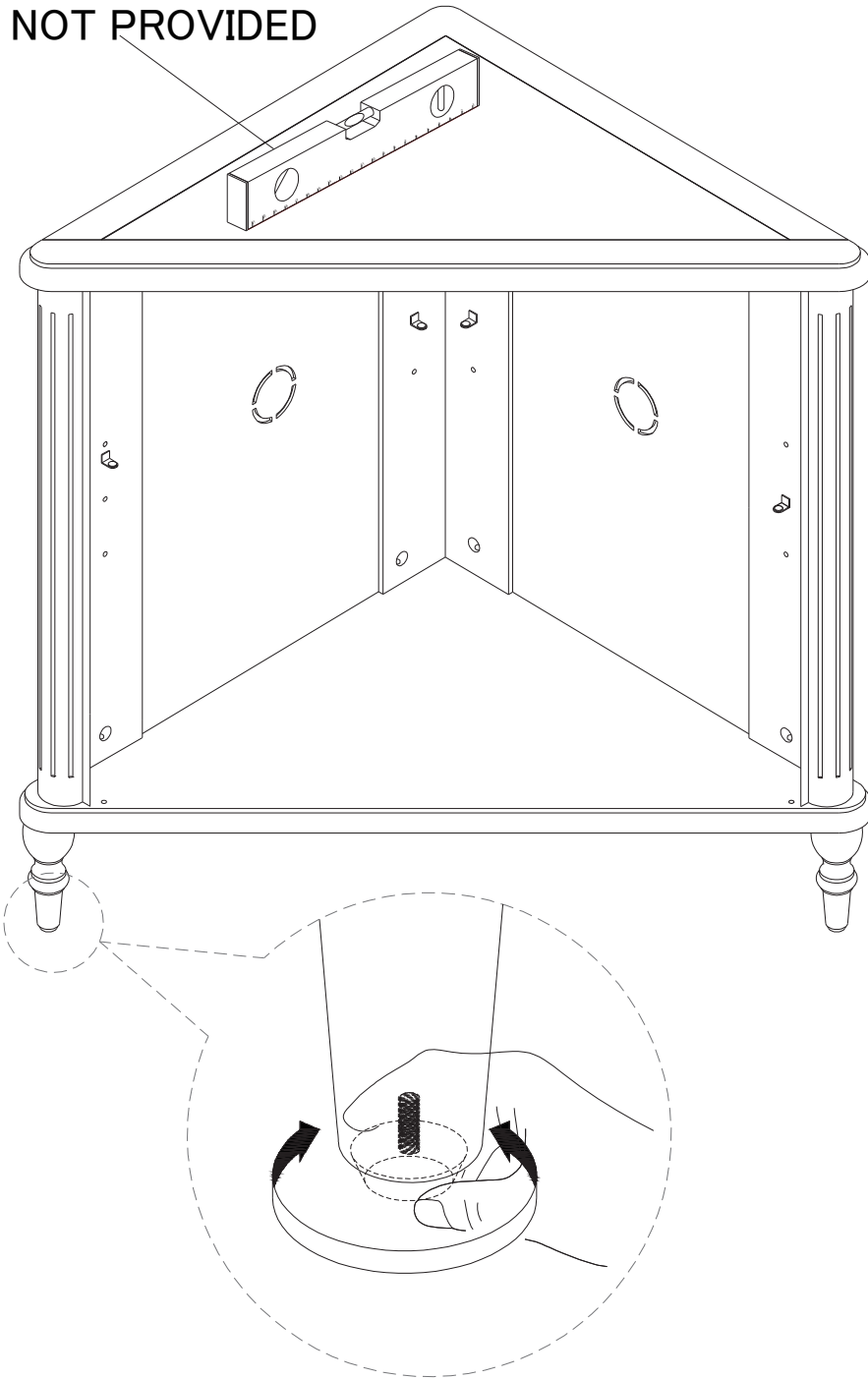



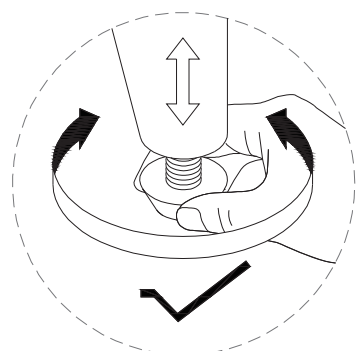
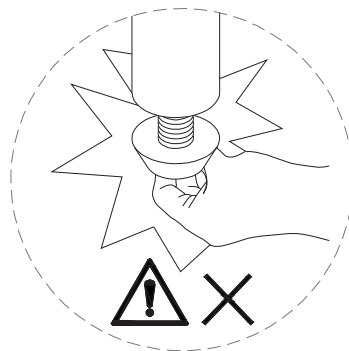

Attention:
Before the next step, adjust the feet of the locker to keep it level.

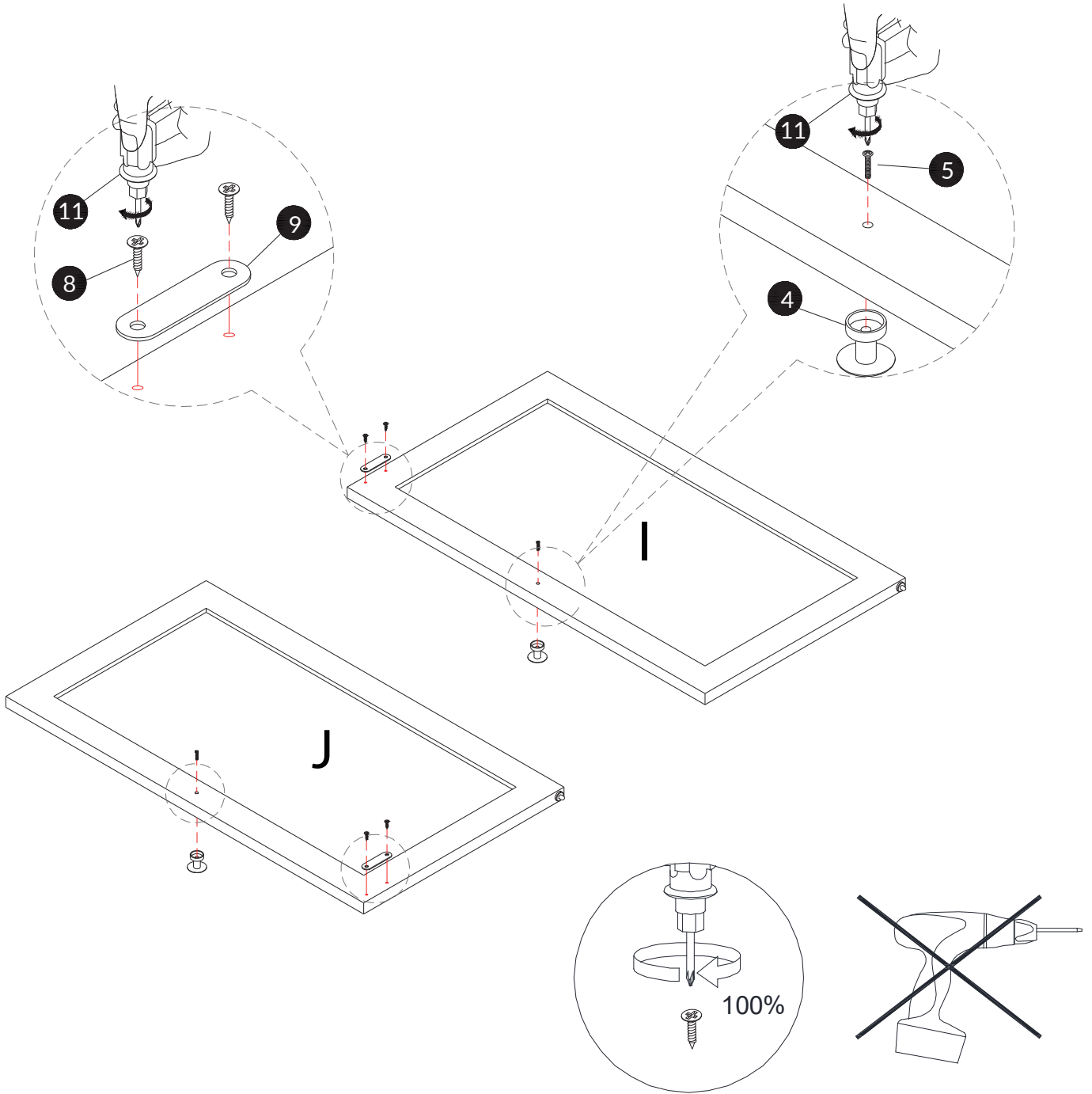

Step 10

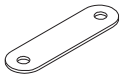
Insert screw 8 through metal plate 9 into the corresponding hole on door panel IJ, and tighten it with screwdriver 11. Insert screw 5 through door panel IJ into the corresponding hole of handle 4, and tighten it with screwdriver 11.

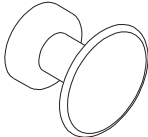

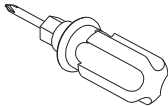
9 x2	8 x4	4 x2	5 x2	11 x1
	 D3x14mm		 D4x28mm	

Step 11

Install doors I and J.

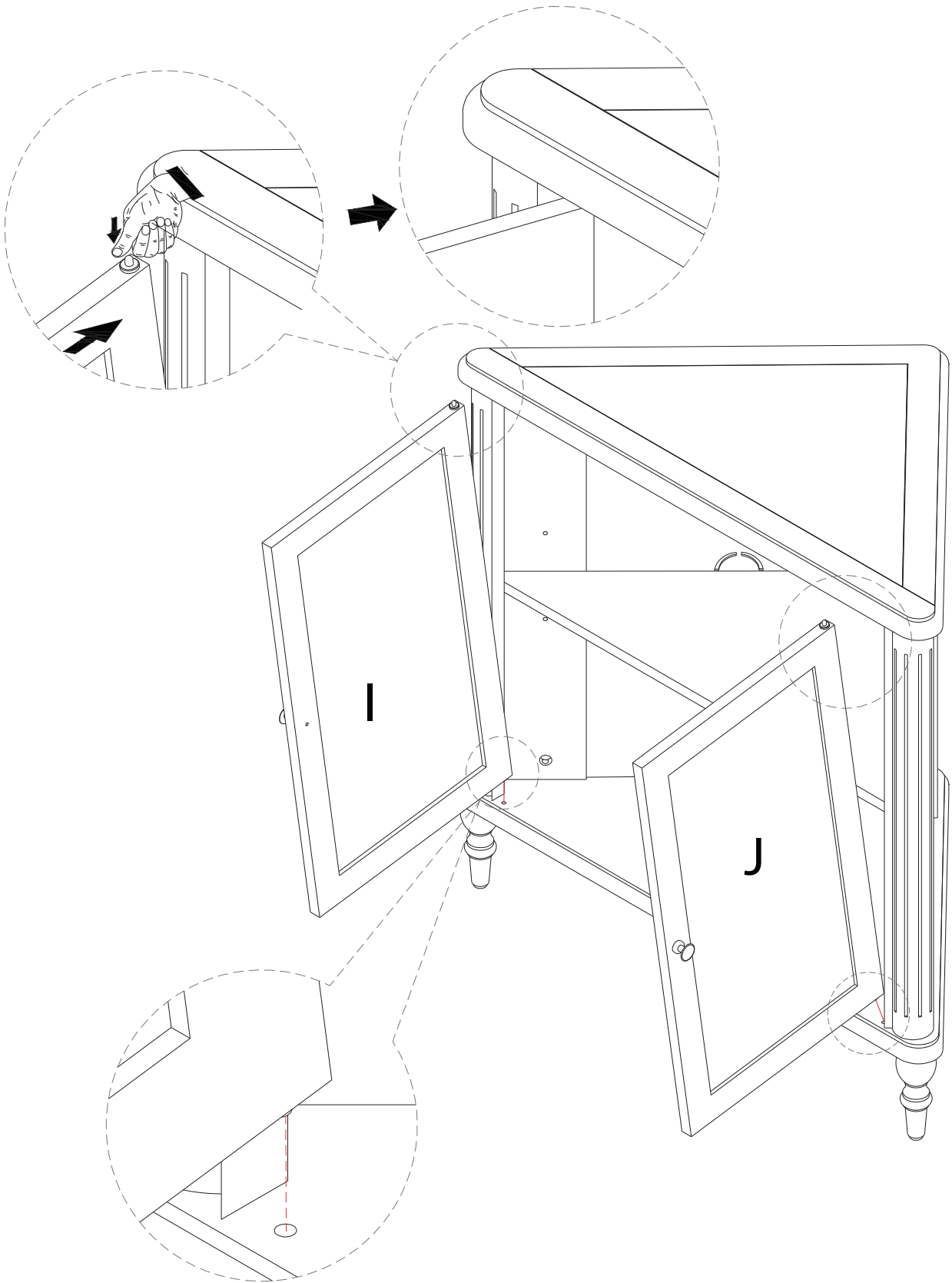

Step 12

Pass screw 14 through the anti-fall part 16 and insert it into the cabinet, then level it and tighten it with screwdriver 11.

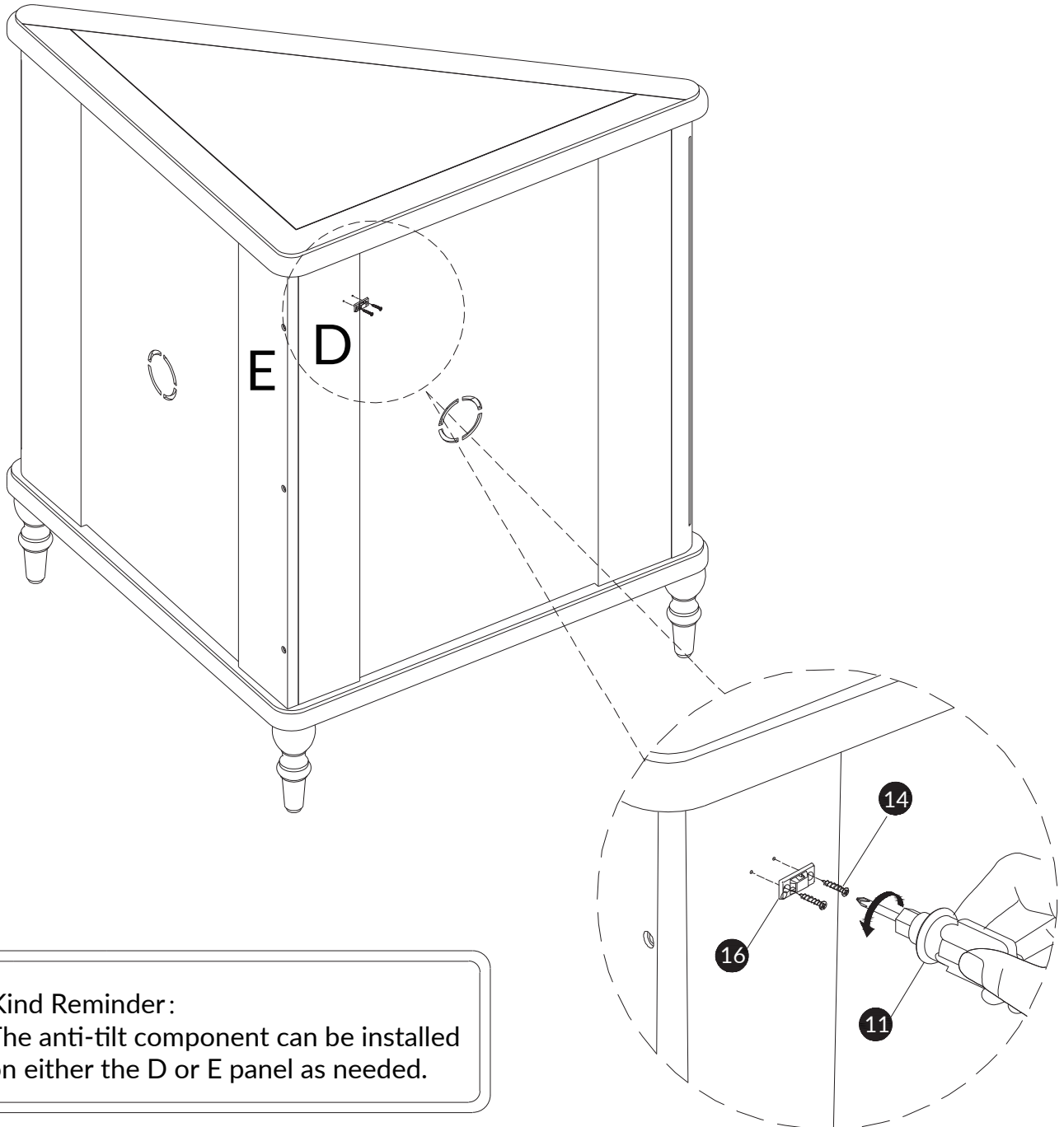

Kind Reminder:
The anti-tilt component can be installed
on either the D or E panel as needed.

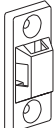
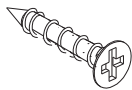
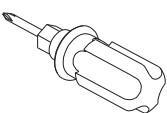
16 x1	14 x2	11 x1
		
	D4x16mm	

Step 13

Install Anti-tip device 16 to the wall in this step.

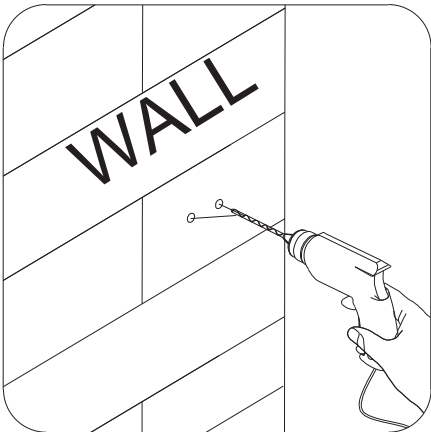
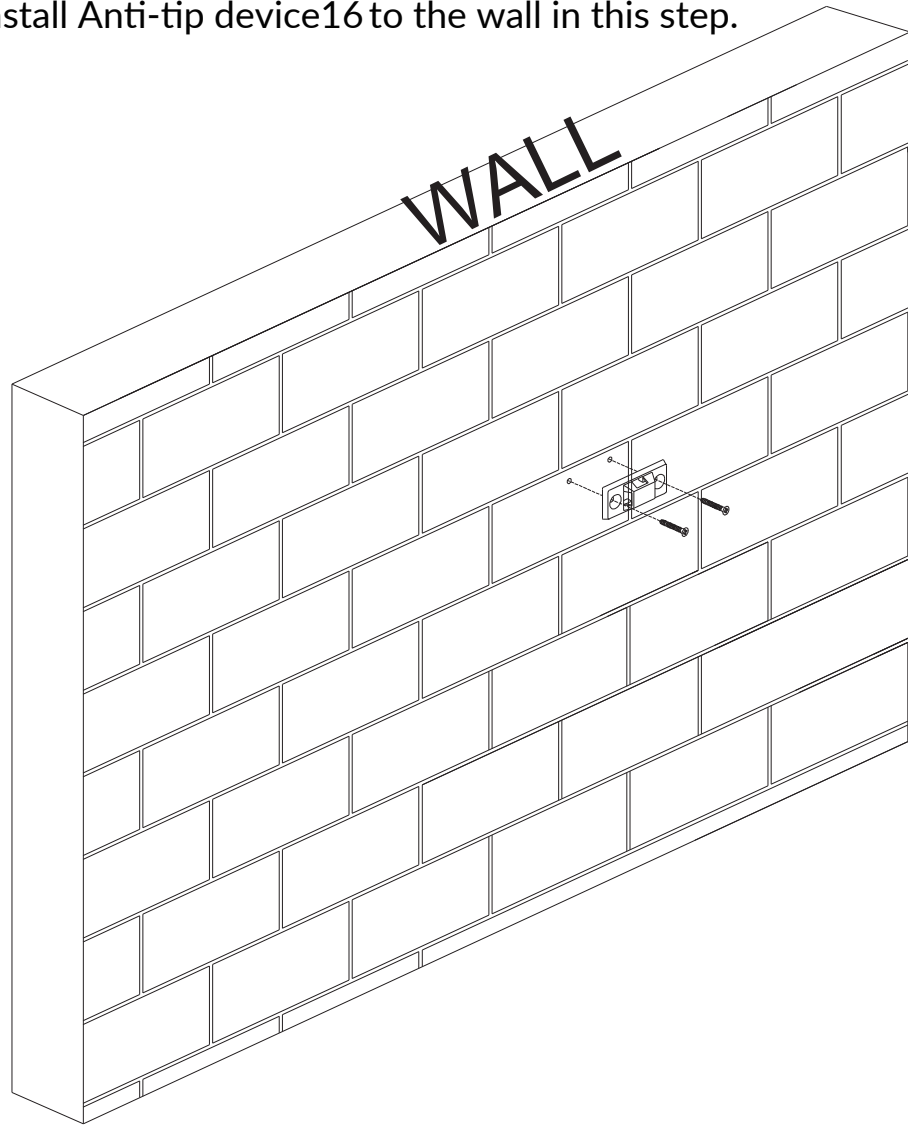

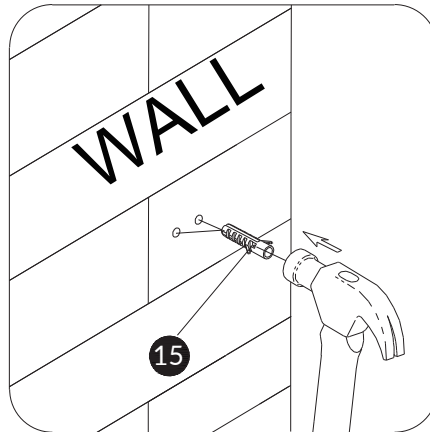

1. Drill a hole in the wall with an electric drill.

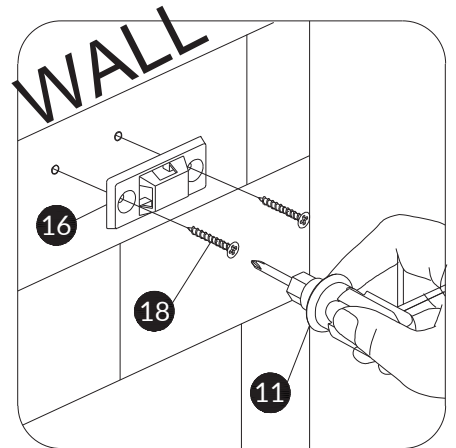

2. Tap the plastic wall anchor into the hole with a hammer.

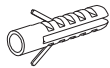
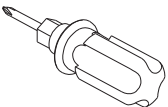

3. Secure the Anti-tip device to the wall with screws

16 x1	18 x2	15 x2	11 x1
	 D4x40mm		

Step 14

WARNING

Children have died from furniture tipover.

To reduce the risk of furniture tipover:

- ALWAYS install Anti-tip device provided.
- For use with televisions weighing 35 lb or less. Use with heavier televisions may result in instability causing tip-over resulting in death or serious injury.
- NEVER allow children to stand, climb or hang on drawers, doors, or shelves.
- NEVER open more than one drawer at a time.
- Place heaviest items in the lowest drawers.

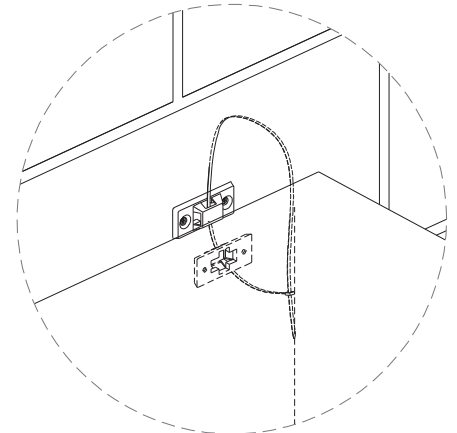
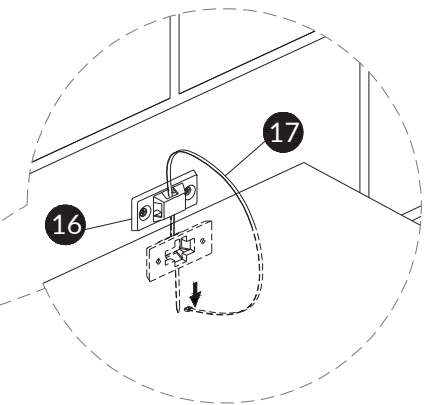
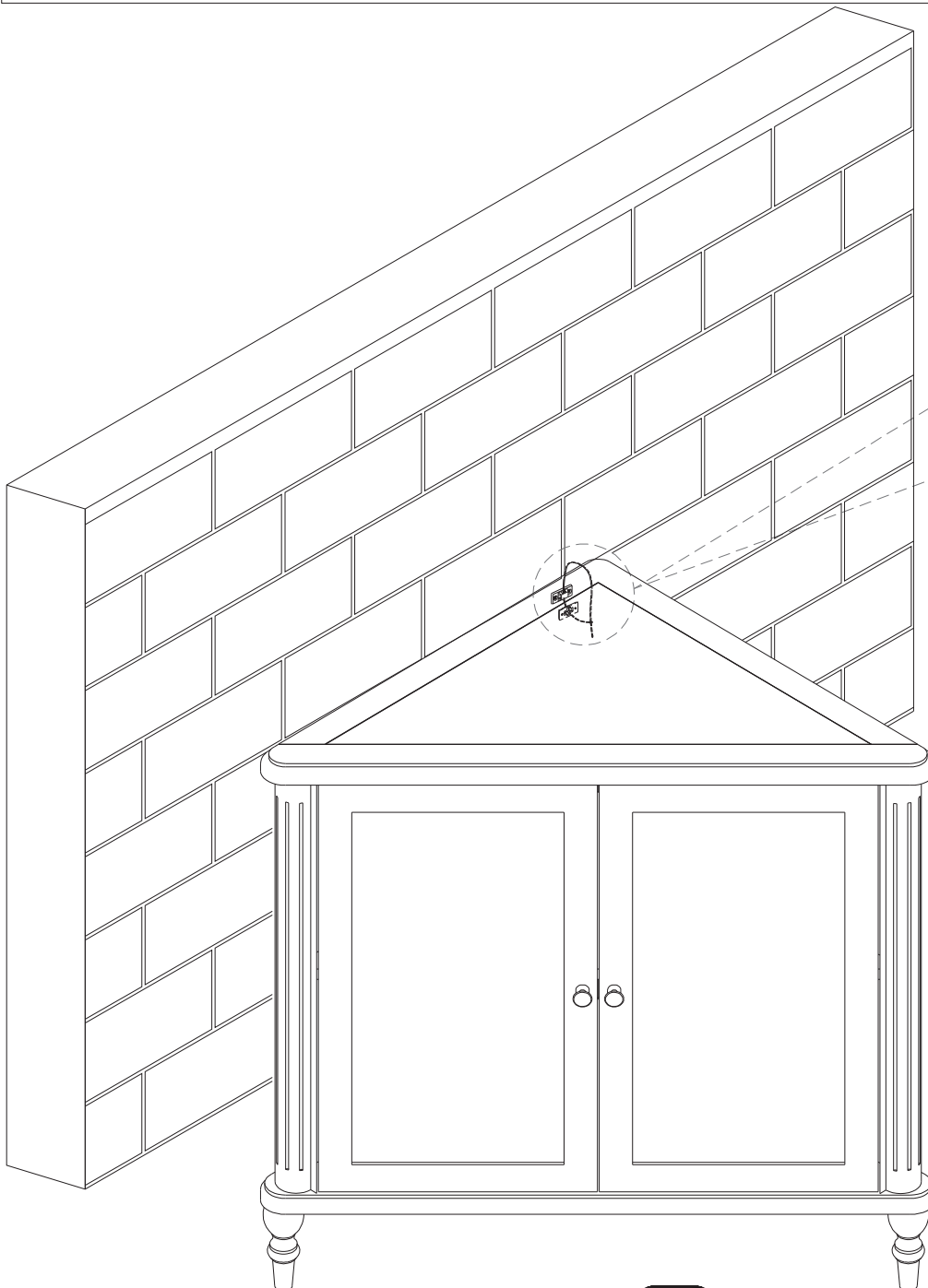

17 x1

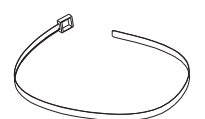

WARRANTY

- We strive to offer quality products, and we also try our best to satisfy every customer who orders from us with products or services as needed.
- Replacement parts can be purchased from our company if available.
- For returns, please check the return policy with the retailer or marketplace where you purchased the item.

We appreciate your purchase.
Brighten your life with our furniture!