

CEILING/WALL TRACK LIGHTING



TOOLS AND MATERIALS REQUIRED:



Phillips
Screwdriver



Wire Cutters



Pliers



Wrench

Wiring supplies
as required by
the Canadian
Electrical Code
and/or the
Quebec
Electrical code

SAFETY PRECAUTIONS:

1. **TURN OFF ELECTRICAL POWER BEFORE STARTING INSTALLATION OF LIGHT FIXTURE.**
2. **THIS PRODUCT MUST BE INSTALLED IN ACCORDANCE WITH THE APPLICABLE INSTALLATION CODE BY A PERSON FAMILIAR WITH THE CONSTRUCTION AND OPERATION OF THE PRODUCT AND THE HAZARDS INVOLVED.**
3. **FIRMLY ATTACH THE FIXTURE GROUND WIRE (BARE COPPER) TO THE MOUNTING BRACKET WITH THE GROUND SCREW (BY WRAPPING AROUND THE GROUND SCREW) AND THEN CONNECT IT TO THE HOUSE SUPPLY GROUND WIRE WITH A WIRE NUT.**

INSTALLATION: NOTE: Product May Not Look Exactly As Shown In Figures.

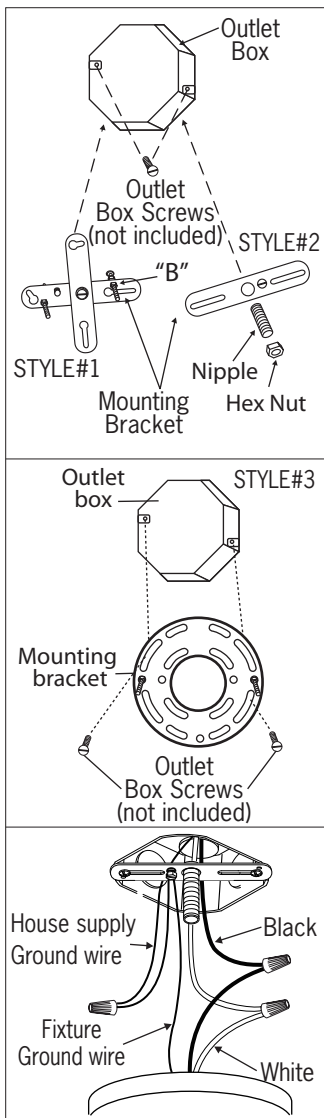

1. Note: Refer to the mounting bracket style that matches the bracket that is included with your fixture.

Style#1 (Crossbar)

Loosen "B". Adjust stud to desired length and lock in place with "B".

Style#2 (Nipple)

Attach nipple to mounting bracket and adjust until it will clear fixture when assembled. Lock in place using the hex nut.

Style#3 (Full Round Bracket)

Mount the mounting bracket to outlet box using outlet box screws (not included). Make sure the studs or nipple on the mounting bracket are facing out from the outlet box.

2. Firmly attach the fixture ground wire (bare copper) to the mounting bracket with the ground screw (by wrapping around the ground screw) and then connect it to the house supply ground wire with a wire nut. Connect the black wire (or wire with marking) from the fixture to the black wire in the electrical box and connect the white wire from the fixture to the white wire in the electrical box.

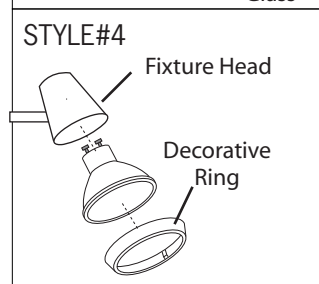
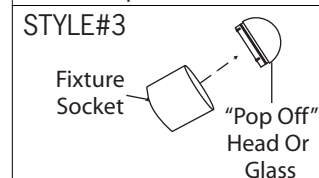
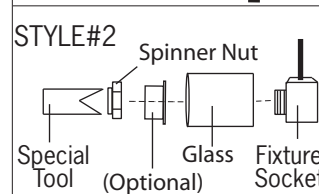
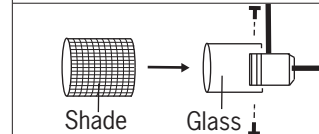
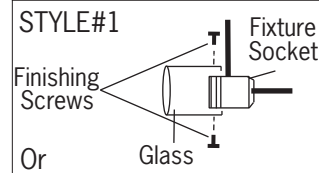
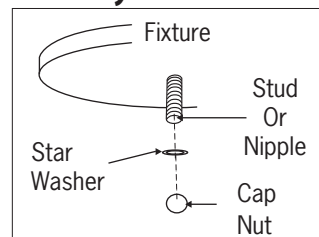

3. Once connections of wires are completed, carefully tuck wires and wire nuts into the outlet box making sure no bare wire (on the black and white) is visible at the wire nuts. Install the light fixture to the wall by aligning the hole(s) in the fixture with the studs or nipple on the mounting bracket. Secure in place with cap nut(s) and star washer(s).

4. Style#1 - Install proper bulb type and wattage. Remove the finishing screws that are already on your fixture. Position glass in place and secure with finishing screws.

Style#2 - Remove spinner nut from the socket. Place the glass onto the fixture socket. Use the special tool that comes with your fixture to tighten the spinner nut onto the socket to secure the glass in place.

Style#3 - Snap "pop off" head or glass onto fixture (push, or push and turn (it depends on the style of your fixture)). Install proper bulb type and wattage (not included).

Style#4 - Install proper bulb type and wattage (not included). Install decorative ring.