

ASSEMBLY INSTRUCTIONS



CAUTION

◆ Inspect the wire insulation for any cuts, abrasions, or exposed copper that may have resulted during shipping. If there is a defect in the wire, do not attempt installation.

◆ Before starting installation of this fixture or removal of a previous fixture, disconnect the power by turning off the circuit breaker or by removing the fuse at the fuse box.

✉ If you need further assistance, please contact us

TOOLS REQUIRED



Ladder



Safety glasses



Electrical tape



Phillips screwdriver



Flat blade screwdriver



Pliers

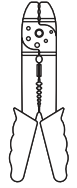

Wire strippers

HARDWARE INCLUDED

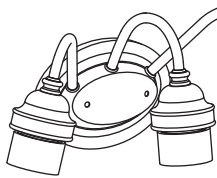

Fixture



Glass Shade

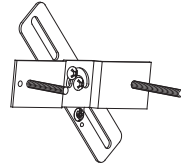

Mounting Unit



Ball Nuts



Mounting Screws



Wire Nuts

***PARTS SHOWN MAY DIFFER SLIGHTLY PER LIGHT FIXTURE**

EXPLODED PARTS

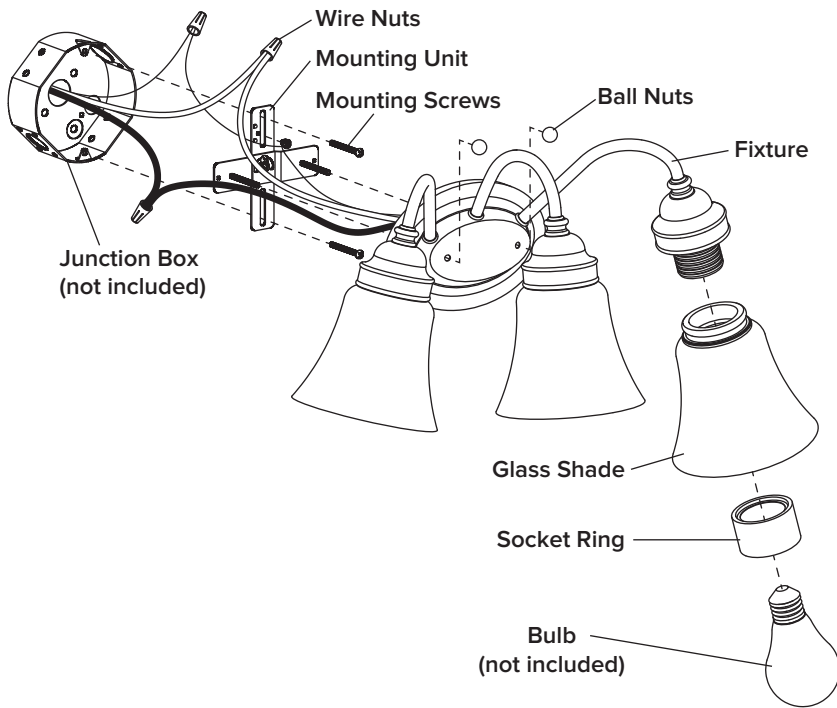

INSTALLATION

STEP 1

Unscrew the **ball nuts** from the **mounting unit**. Use the **mounting screws** to attach the **mounting unit** to the junction box (not included).

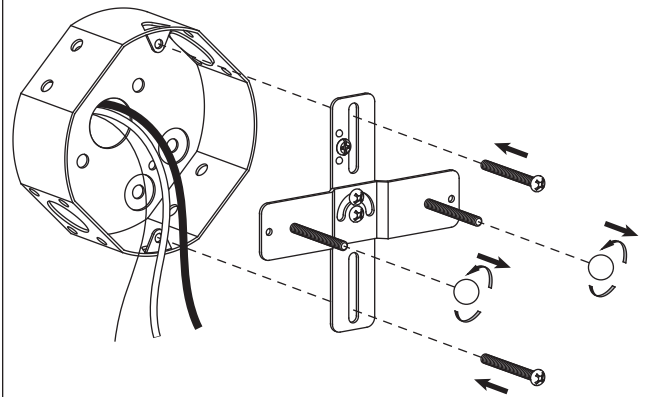

STEP 2

Make the electrical connection from the junction box (not included) to the **fixture**. Connect the ground wire to the **mounting unit** using the preinstalled green ground screw. Next, connect the live wire, neutral wire and ground wires with the supplied **wire nuts**. Secure with electrical tape.

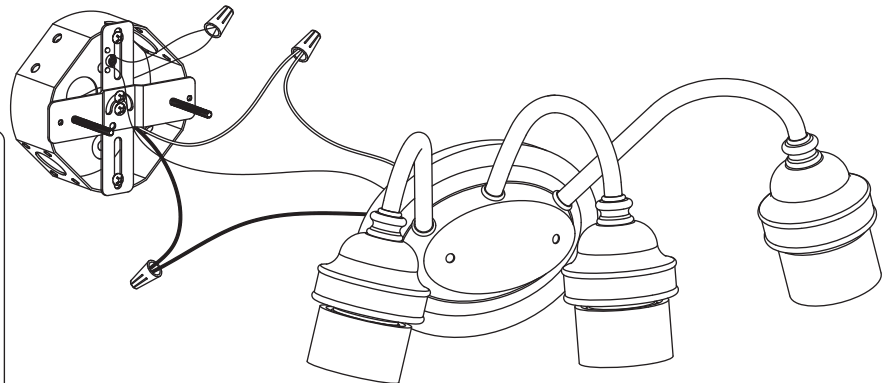
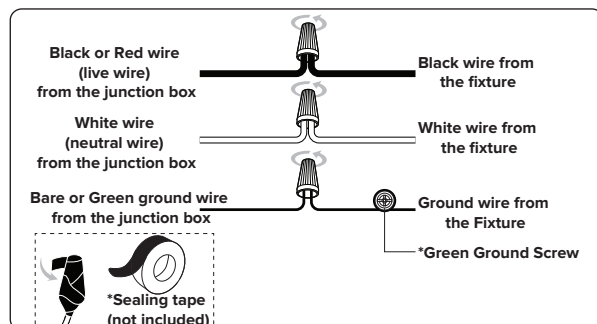

ASSEMBLY INSTRUCTIONS (INSTALLATION)

STEP 3

Attach the **fixture** to the **mounting unit** through screws holes as shown, and secure it with **ball nuts**.

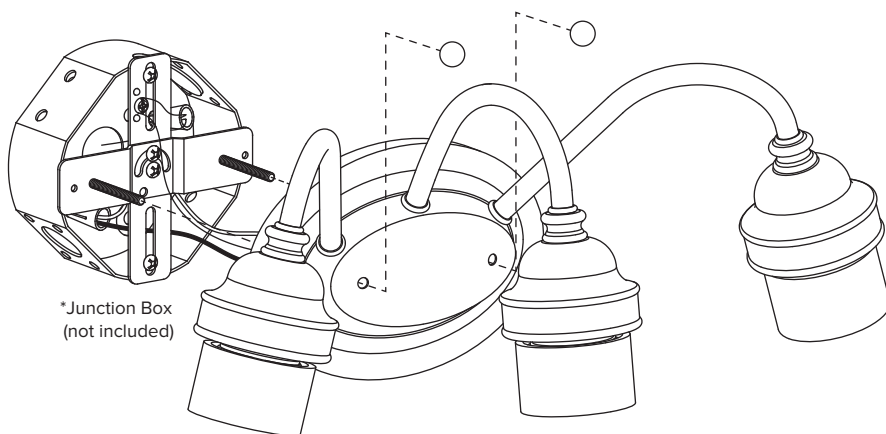

STEP 4

Remove the **socket ring** from the socket. Use the **socket ring** to attach the **glass shade** to the **fixture**.

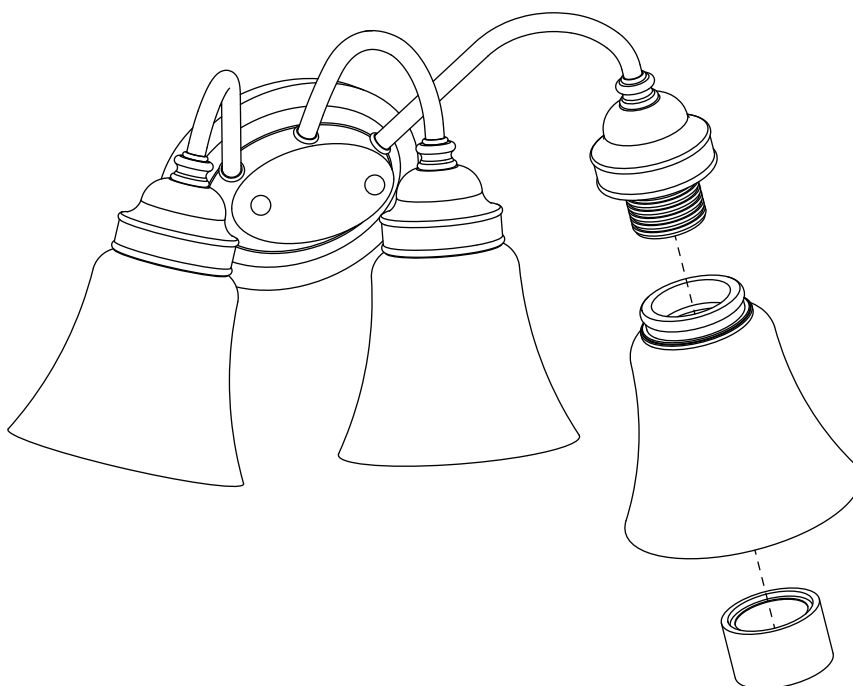

STEP 5

Install bulb (not included)

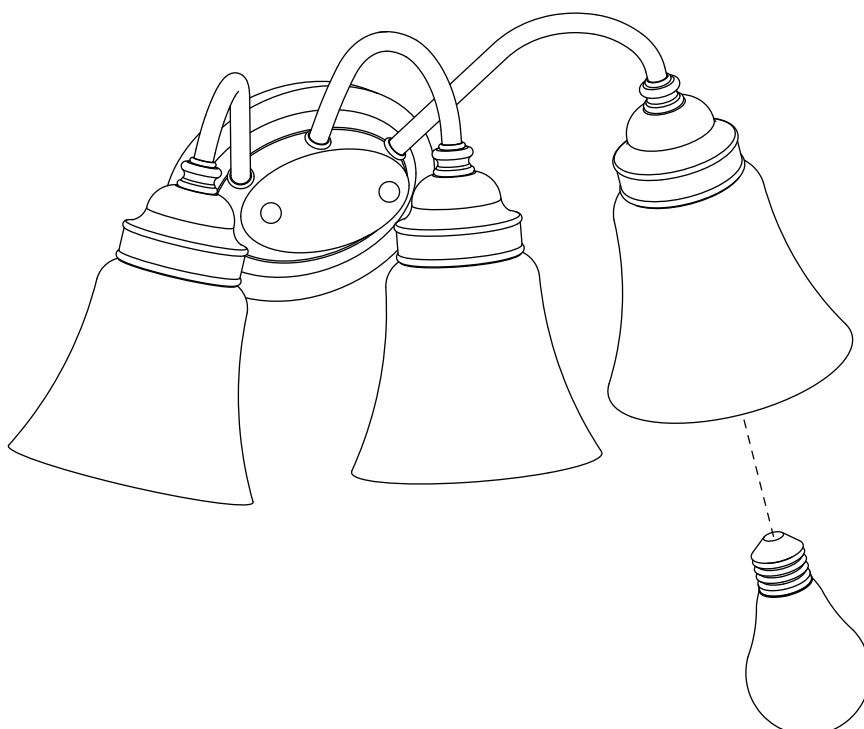

BULB BASE TYPE
Medium (E26)