

CARE AND MAINTENANCE





Always use felt pads under all articles to prevent discoloration or softening of the lacquer . Wipe up spills immediately and avoid common hazards such as hot dishes, harsh solvents and abrasives. Cleaning should be done with a soft lint free cotton cloth dampened with water or furniture polish. On highly used surfaces we recommend applying a quality paste wax which should be used on a regular basis to provide additional protection from scratches and spills. How often you apply the wax depends on how much wear the furniture receives.

NOTICE

- * Please make sure that you have all parts indicated before you begin assembly of this item
- * This item should be assembled on a soft surface to prevent scratching the finish during assembly

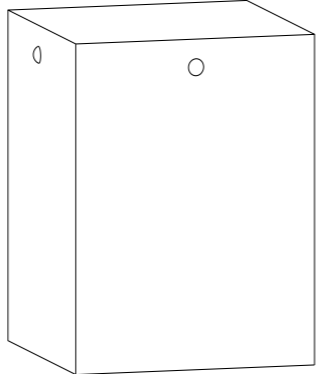
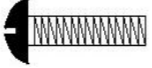
Part List and Hardware List

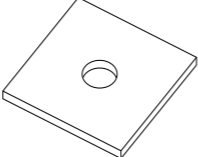
Product Dimensions: L23.62xW23.62xH15.75 inches

PIECE	DESCRIPTION	PICTURE	QUANTITY
A	CONCRETE TOP		1X
B	CONCRETE BASE		1X
H1	BOLT M8		2X
H2	Wahser		4x
H3	Square washer		4x
H4	ALLEN KEY		1X

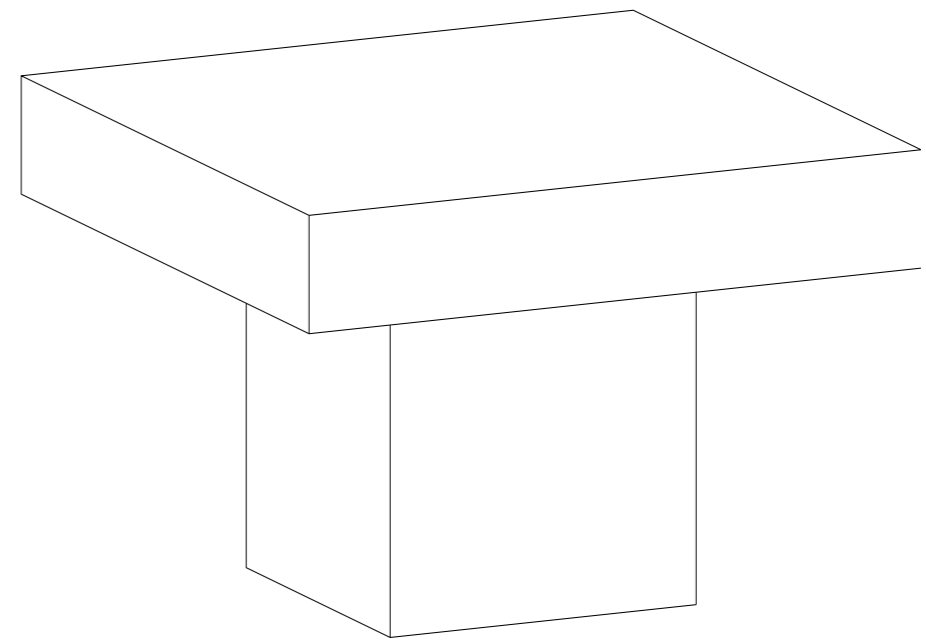

PREPARATION

Before beginning assembly of product, make sure all parts are present. Compare parts with package contents list and hardware contents list.

If any part is missing or damaged, do not attempt to assemble the product.

Estimated Assembly Time: 10 minutes.

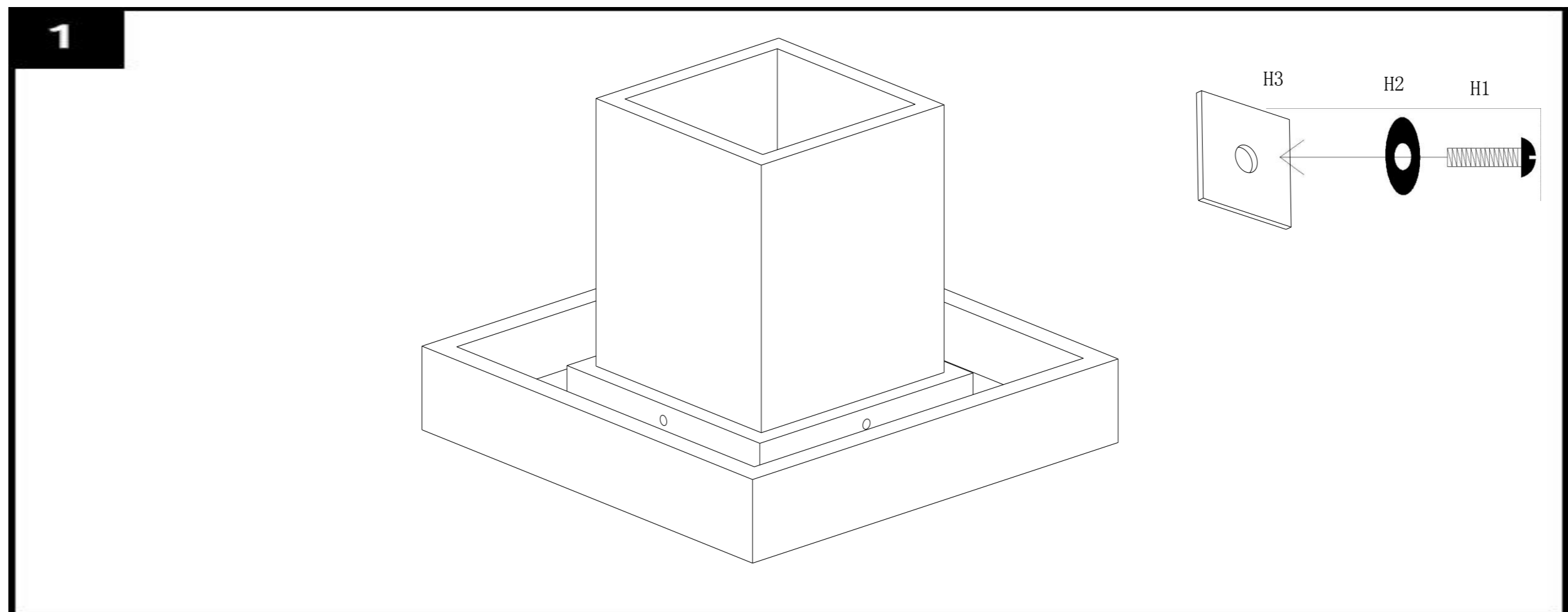

Step 1 : Use allen key (H4) to tight the bolt M8(H1) to press on plastic plug that is fixed into concret base . Tighten the bolt untill it touches the plastic plug without piercing