

INSTALLATION INSTRUCTIONS

MANUFACTURING QUALITY
CEILING FANS SINCE FOREVER.

Important: Please read and save these instructions before installation

Basic Product Specifications

| | | | |
|-----------------|-----------|---------------|--------------------------|
| | | Voltage | 120V |
| Fan Blade Span | 52" | Rated Wattage | 42W (Fan 24W / Lamp 18W) |
| Gross Weight | 17.9 lbs. | Motor RPM | 70-200 RPM |
| Maximum Airflow | 4040 CFM | Maximum Noise | 58 dB(A) |

This Ceiling Fan has :



Variable Speed Options



Forward / Reverse
Fan Direction

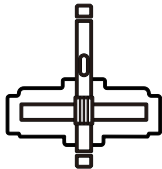

DC Motor, stable & silent,
suitable for indoor use



Built with premium materials
for durability & power



Pull Chain Control

SAFETY PRECAUTIONS

READ AND SAVE THESE INSTRUCTIONS

- Before you begin installing the fan, shut power off at the circuit breaker of the fuse box.
- Make sure that all electrical connections are in accordance with National Electrical Code, ANSI/NFPA 70 and local codes. Hire a licensed electrician if you are unfamiliar with installing electrical wiring.
- Make sure the installation site you choose allows the fan blades to rotate without any obstructions. Allow a minimum clearance of 2.1m (7 feet) from the floor and 18 inches from the tip of the blades to the wall.
- The outlet box and support structure must be securely mounted and capable of reliably supporting a minimum of 35 pounds. Use only U.L. listed outlet boxes marked "Acceptable for Fan Support of 15.9 kg (35 lbs) or less".
- Before and after you install the fan, make sure that all mounting components are secured to prevent the fan from falling.
- Do not insert anything into the fan blades while the fan is operating.
- To change the direction of the rotation of the blades, the fan must be in operation mode.
- All screws must be checked and retightened where necessary before installation.
- After making the wire connections, the wires should be spread apart with the grounded conductor and the equipment-grounding conductor on one side of the outlet box and the ungrounded conductor on the other side of the outlet box.
- The splices after being made should be turned upward and pushed carefully up into the outlet box. Conductor wiring identified as grounded is to be connected to a grounded conductor of power supply. Conductor wiring identified as ungrounded conductor is to be connected to an ungrounded conductor. Conductor wiring identified for equipment grounding is to be connected to an equipment- grounding conductor.
- This device complies with part 15 of the FCC Rules. Operation is subject to the following two conditions: (1) This device may not cause harmful interference, and (2) this device must accept any interference received, including interference that may cause undesired operation.

SAFETY PRECAUTIONS

- **CAUTION:** Read all instructions and safety information before installing your new fan. Review accompanying assembly diagrams.
- **WARNING:** Mount only to an outlet box marked acceptable for fan support.
AVERTISSEMENT: Assembler uniquement à une boîte de sortie jugée acceptable pour retenir un ventilateur.
- **WARNING:** To reduce the risk of fire, electric shock, or personal injury, mount to a structural framing member or to an outlet box marked acceptable for fan support of 15.9 kg (35 lbs) or less. For outlet box mounting, use mounting screws provided with the outlet box.
AVERTISSEMENT: Afin de réduire les risques d'incendie, de choc électrique ou de blessures corporelles, ils doivent être montés sur des éléments de charpente structurale ou sur des boîtes de sortie marquées d'un support de ventilateur acceptable de 15,9 kg (35 LB) ou moins. Pour l'installation de la boîte de sortie, utilisez les vis de montage fournies avec la boîte de sortie”
- **CAUTION:** To reduce the risk of injury, use only the screws provided with the outlet box in conjunction with the lock washers.
- **WARNING:** To reduce the risk of personal injury, do not bend the blade bracket when installing the brackets, balancing the blades, or cleaning the fan. Do not insert foreign objects in between rotating fan blades.
- **CAUTION:** To reduce the risk of electric shock, disconnect the electrical supply circuit to the fan before installing the light kit.
- **WARNING:** To reduce the risk of fire or electric shock, this fan must be installed with a general use, non-dimmable, single gang, isolating wall control/switch.
- **WARNING:** To reduce the risk of fire or electric shock, do not use this fan with any solid-state speed control device.
AVERTISSEMENT: Ne convient pas à des régulateurs de vitesse à semi-conducteurs.
- **NOTE:** The important safeguards and instructions appearing in this manual are not meant to cover all possible conditions and situations that may occur. It must be understood that common sense, caution and care are factors which cannot be built into this product. These factors must be supplied by the person(s) installing, caring for and operating the unit.
- **CAUTION:** The light source is designed for this specific application and can overheat if serviced by untrained personnel. If any servicing is required, the product should be returned to an authorized service facility for examination or repair.
- **WARNING:** Do not use corrosive detergents for cleaning.
- **WARNING:** To reduce the risk of fire, electric shock, or injury to persons, do not use replacement parts that have not been recommended by the manufacturer. (e.g. Parts made at home using a 3D printer).
- **NOTE:** Before installing the fan, please check and inspect all of the fan components and make sure they have all been received in good condition. Contact the manufacturer if there are any missing, damaged, or broken parts.

Table of Contents

| | |
|----|----------------------------------|
| 06 | Fan Diagram |
| 07 | Disassembly |
| 08 | Fan Blades / Light Kit |
| 09 | Downrod |
| 10 | Mounting Bracket |
| 11 | Hanging / Safety Cable |
| 12 | Wiring / Canopy |
| 13 | Lampshade / Power On |
| 14 | Operation |
| 15 | Troubleshooting |
| 16 | Care & Cleaning / FCC |

Fan Diagram

Before installing, please check to make sure you have received all the necessary components for installation. Some extra hardware may also have been included.

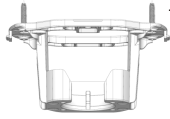

Mounting Bracket



X4

ST5X24mm
Wood Screw



X2

Wire Nut

For installing the mounting bracket and wiring the fan

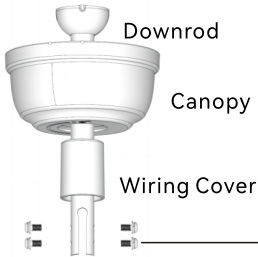

Downrod

Canopy

Wiring Cover



X4

M6X12mm
Rod Screw

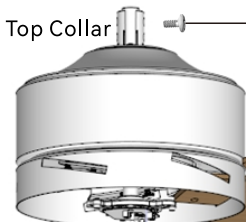

Top Collar

Motor



X1

M4X12mm
Safety Cable Screw
(Pre-installed)



X15

M5X12mm
Blade Screw & Washer



Blade **X5**

For installing the blades



Light Kit Pan



Light Kit



Lampshade



X3

ST4X8mm
Light Kit Assembly Screw
(Pre-installed)



Pull Chain
Pendant **X2**

Installation: Disassembly

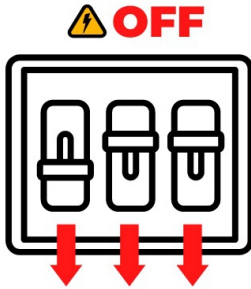

WARNING: To avoid serious injury or death, turn off the power at the circuit breaker before installing the fan.

Tools you'll need



Phillips screwdriver



Step ladder

1. Disassemble the Light Kit

1.1 Take the motor assembly out of the box and detach the light kit by pulling it away from the assembly. The light kit is attached to the assembly by magnets.

1.2 Unscrew the three pre-installed light kit assembly screws that attach the light kit pan to the PCB board of the motor assembly. Rotate the light kit pan and remove it from the assembly. Save the screws for later use.

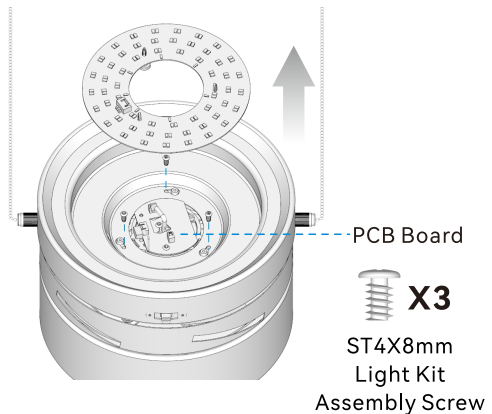

Fig. 1.1

Installation: Fan Blades / Light Kit

2. Install the Fan Blades

Find the 15 blade attachment screws and washers in the hardware pack. Slide the blades through the center band of the motor housing and align the holes. Use the blade screws and washers to securely attach the blades in place.

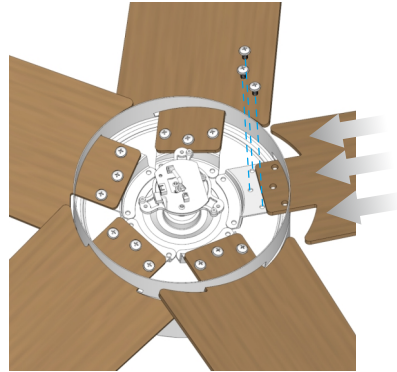

Fig. 2.1

3. Install the Light Kit Pan & Light Kit

3.1 Connect the male plug (a) from the light kit pan to the female terminal block (b) on the PCB board as shown in Fig. 3.1.

3.2 Thread the wire plug (c) from the PCB board through the center hole of the light kit pan. Attach the light kit pan to the PCB board of the motor housing.

3.3 Align the light kit pan with the PCB board. Reinstall the three light kit assembly screws that were removed in step 1. Make sure all screws are securely tightened.

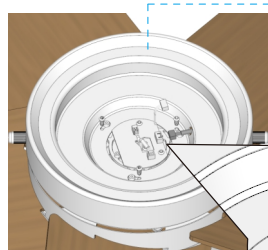
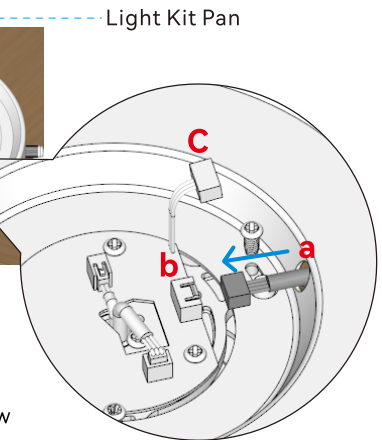

Fig 3.1



X3
ST4X8mm
Light Kit Assembly Screw



Light Kit
Terminal Block

3.4 Allow the wire plug (c) to pass through the light kit. Reinstall the light kit. The light kit will be magnetically attracted to the pan with the help of magnets.

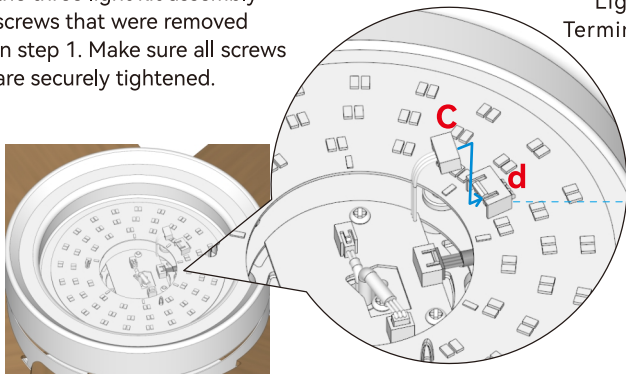

Fig 3.2

3.5 Insert the wire plug (c) into the light kit terminal block (d) on the light kit as shown in Fig 3.2.

Installation: Downrod

4. Attach the Downrod

4.1 Assemble the downrod as shown in Fig. 4.1. Insert the downrod through the canopy and wiring cover.

Note: If you choose to install a safety cable onto your ceiling fan, you will also need to run it through the downrod.

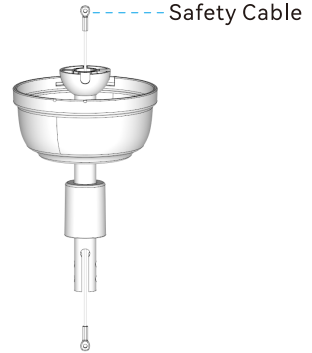

Fig. 4.1

4.2 Thread the motor wires through the downrod, pull out the slack from the motor wires and safety cable upward, and insert the downrod into the collar on top of the motor assembly. Align the holes at the bottom of the downrod with the holes in the collar on top of the motor housing.

Remove the pre-installed safety cable screw. Install the safety cable and re-insert the previously removed screw back through the hole, but do not tighten yet. Check the top collar to make sure the holes are aligned to install the four rod screws (included in the package), and securely tighten down all the screws to ensure a proper connection as shown in Fig. 4.2.

Slide the wiring cover down until it rests on top of the motor assembly as shown in Fig. 4.3.

Note: Before sliding the downrod over the collar on top of the motor assembly, make sure to remove the end of the safety cable from the downrod.

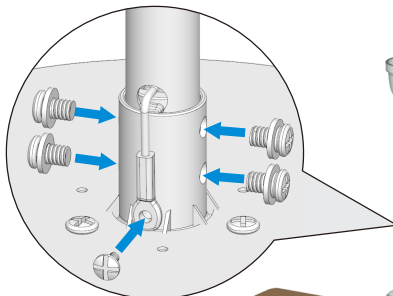
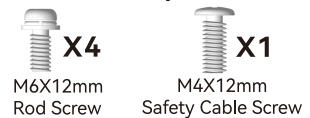

Fig. 4.2

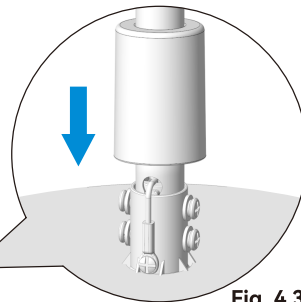
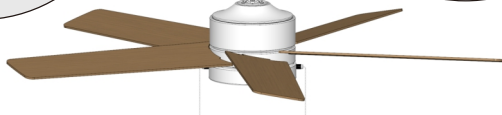

Fig. 4.3



Installation: Mounting Bracket

5. Install the Mounting Bracket

Install the mounting bracket to the ceiling box, as shown in Fig. 5.1 below. Rotate the mounting bracket in different directions so that the bracket mounting holes match the screw holes of the ceiling box.

Note: This mounting bracket is a standard cable box. If the mounting bracket is installed at the outlet box, it should be installed on the outlet box with two screws matching the outlet box itself, as shown in Fig. 5.1.

WARNING: DO NOT use plastic outlet box. Use only U.L. listed outlet boxes marked "Acceptable for Fan Support of 15.9 kg (35 lbs) or less".

This bracket can also be mounted to a wooden ceiling beam. In that case, use the four ST5x24mm wood screws to lock the corresponding holes on the left and right sides of the bracket as shown in Fig. 5.2.

Note: The wooden ceiling beam must meet the tensile test of 30kg for installation.

It is also possible to install the mounting bracket directly to a concrete ceiling and use four anchors (not included) to lock the left and right corresponding holes of the bracket to the ceiling.

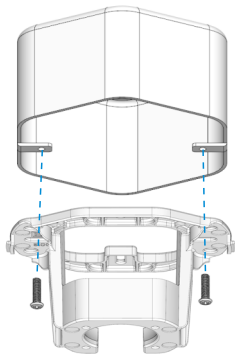

Fig. 5.1

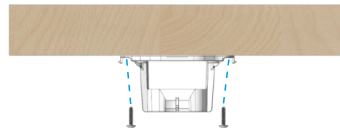

Fig. 5.2

If you have an angled or vaulted ceiling (see Fig. 5.3)

1. When installing the mounting bracket, the bracket groove should be facing upward, as shown in Fig. 5.4.

Do not install the bracket with the groove facing downward, as shown in Fig. 5.5.

2. You will need a longer downrod.

3. The maximum angle is 27 degrees.

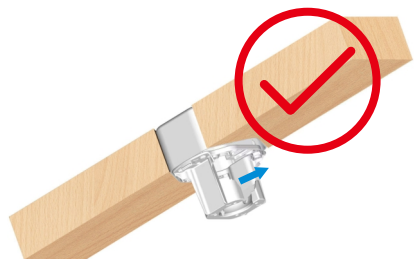

Fig. 5.4

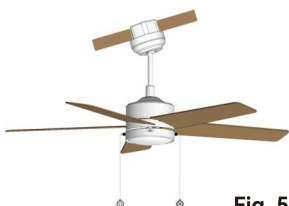

Fig. 5.3

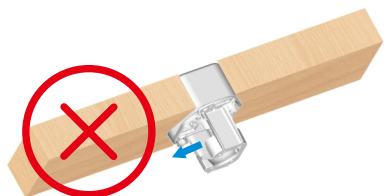

Fig. 5.5

Installation: Hanging / Safety Cable

6. Hang the Fan

WARNING: To reduce the risk of fire, electric shock, or other personal injury, mount the fan only to an outlet box or supporting system marked acceptable for fan support and use the mounting screws provided with the outlet box.

WARNING: Check to see that all connections are tight, including ground, and there are no visible bare wires at the wire nuts (except for the ground wire).

WARNING: To reduce the risk of fire or electric shock, do not use this fan with any solid-state speed control device.

WARNING: To avoid any electrical shock, be sure electricity is turned off at the main fuse box before wiring.

6.1 Install the ball end of the downrod into the opening of the mounting bracket. Rotate the downrod until the tab on the mounting bracket is securely seated in the slot in the downrod ball, as shown in the enlarged image in Fig. 6.1.

⚠ WARNING

The fan and/or downrod should not rotate in the mounting bracket when installed correctly. Failure to properly align the slot in the downrod ball with the tab on the mounting bracket may result in the fan falling, causing serious injury or death.



6.2 Attach the other end of the safety cable to a secure location. Fasten the safety cable to the ceiling using a screw and washer (not included), as depicted in Fig. 6.2.

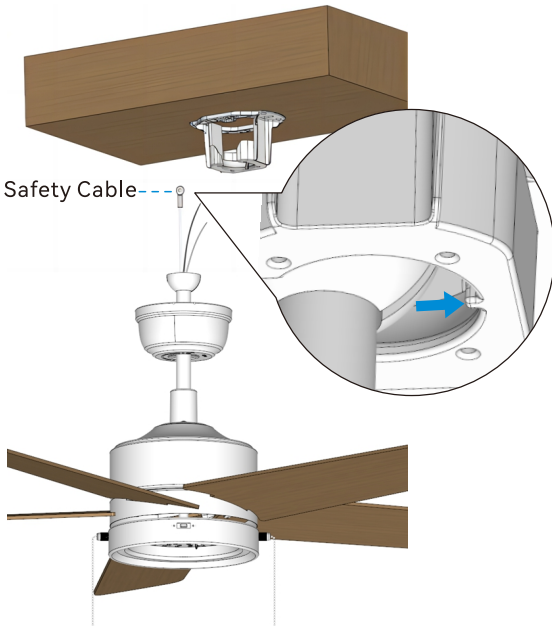

Fig. 6.1

Note: Installing the ceiling fan with a safety cable is an extra safety feature. It secures the fan to the ceiling hook or other attachment point and prevents the fan from falling even in the case of material failure.

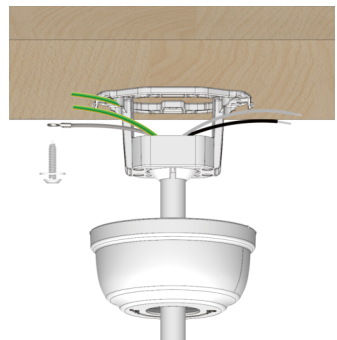

Fig. 6.2

Installation: Wiring / Canopy

7. Connect the Wiring

Connect the Green/Yellow wires from the mounting bracket and the downrod ball to the supply Ground wire using a wire nut.

Connect the White wire from the motor to the supply White (Neutral) wire using a wire nut. Connect the Black wire from the motor to the supply Black/Red (Hot/Live) wire using a wire nut.

Make sure all the wires are connected to the correct colors as shown in Fig. 7.1. Then, hide the wiring inside the ceiling.

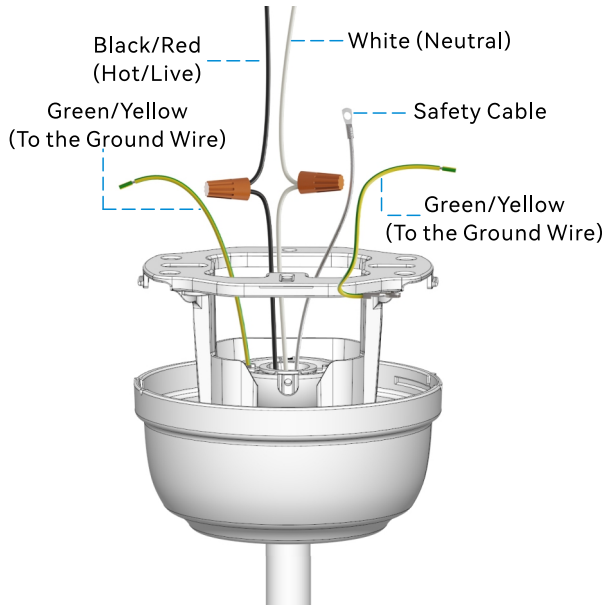

Fig. 7.1

8. Install the Canopy

There are two types of canopies and two ways to install them. Please follow the instructions below before installation.

A: The screws of the mounting bracket are exposed.

Make sure all wires are tucked into the canopy. Raise the canopy to the mounting bracket and align the holes in the canopy with the two mounting bracket screws. Then, turn the canopy in the direction of the arrow shown in Fig. A until the mounting bracket screws engage from the larger slots of the canopy to the smaller ones. Tighten the screws securely to fix the canopy onto the mounting bracket.



(A)

Installation: Lampshade / Power On

B: There are no screws on the mounting bracket.

Make sure all wires are tucked in the canopy. Raise the canopy to the mounting bracket and align the two notches inside the top of the canopy with the two tabs on the top of the mounting bracket. Attach the canopy by lifting and twisting it until it stops.

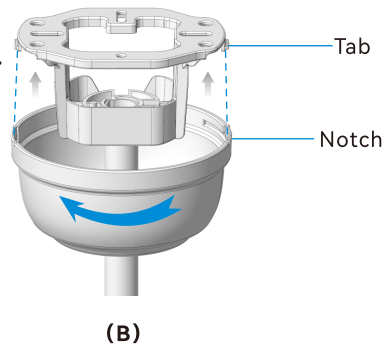

9. Install the Lampshade

Align the slots of the lampshade with the slots of the light kit pan, and turn the lampshade clockwise to securely lock it into place, as shown in Fig. 9.1. Attach the decorative pull chain pendants to the chains coming out of the switch cover.

Note: Do not over tighten the lampshade.

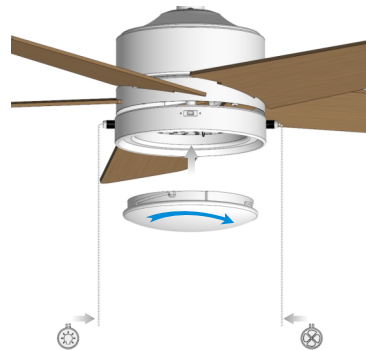

Fig. 9.1

⚠ WARNING

To prevent SERIOUS INJURY or DEATH, make sure that the lampshade is properly secured. Allow the lampshade to cool completely before attempting to remove it.



10. Power On

At this time, the ceiling fan has been installed. Turn on the power supply from the circuit breaker of the main switch or the room where the ceiling fan is installed. Once the power is on, check to see if the fan light is illuminated.

Note: Please be aware that this ceiling fan may produce noticeable operating sounds at specific wind speeds. This is a normal operating characteristic and does not indicate any issues with its functionality.

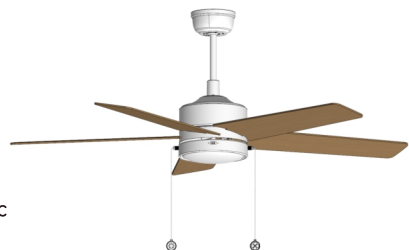

Operation

Turn on the power and check the operation of your fan.

The fan pull chain controls the fan speed settings:

- 1 pull= (Low Speed)
- 2 pulls= (Medium Speed)
- 3 pulls= (High Speed)
- 4 pulls= Fan Off

The light pull chain controls the light brightness:

Upon powering on, the light defaults to 50% brightness

- 1 pull= (100% Brightness)
- 2 pulls= (10% Brightness)
- 3 pulls= (50% Brightness)

After turning on the light, pull the light pull chain within 5 seconds to cycle through the 3 brightness settings: 100%, 10% and 50%. The light will remember the last used setting due to its memory function.

If no further action is taken within 5 seconds after turning on the light, pulling the chain again will turn the light off.

Power-Off Memory Function

If the fan is running and there is a sudden power outage, the fan and light will automatically resume operation at the last used settings when power is restored due to the power-off memory function, unless there is subsequent user intervention.

Forward and reverse direction function

Forward function

When set to this function, the fan will rotate counterclockwise to create a cooling effect. This function is recommended during warmer weather to circulate the hot air away from your living space.

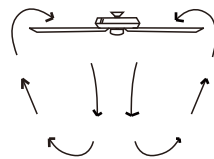

Reverse function

When set to this function, the fan will rotate clockwise. Use this function during cooler weather to recirculate warm air and distribute it evenly throughout the room.

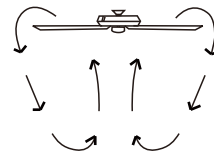

Troubleshooting

Try these troubleshooting steps before contacting Customer Service. For additional operation, maintenance, and troubleshooting information, please contact our customer service center.

| SYMPTOM | POSSIBLE SOLUTION |
|--|--|
| Fan not spinning | <p>① Make sure the fan is getting power. ② Check your circuit breaker or fuse panel and wall switch for functionality. ③ Check to make sure the fan wires are correctly connected to the house wires. ④ Use a multi-meter and test the wiring harness to see if there is any electrical output. ⑤ All the pin wiring on the circuit board must be inserted tight and in the correct position. ⑥ Make sure the fan blades spin freely. ⑦ If you're using a wall control, check the power to the breaker from your control and try working your ceiling fan manually. (Normal switch only for the fan power on/off)</p> |
| Fan light not working | <p>① Make sure LED wires are connected to the circuit board. ② Make sure the whole fan is powered.</p> |
| The fan is noisy and wobbling | <p>① Check if the blade screws are NOT rubbing against any part of the motor housing. ② Check the pin wires are NOT connected against any moving parts. ③ Check the down fan cup is NOT hitting the motor. ④ Confirm the canopy is NOT touching the ceiling while the fan is in operation. ⑤ Check the down rod is NOT slanted. ⑥ Tighten any loose screws on the light kit, fan blades, motor coupling, down rod, brackets and mounting hardware. ⑦ Confirm the hanger ball is firmly seated in the mounting bracket. ⑧ The ceiling beam must meet the minimum tensile test strength of 30kg for installation. ⑨ Make sure the blades and brackets are NOT bent or deformed. ⑩ Verify the wire connections are not rattling against each other. ⑪ Verify the fan blades are not cracked. If the fan blades are cracked, replace the damaged blades with a new blade set from the same brand as your ceiling fan to ensure compatibility. ⑫ Confirm the light kit is NOT slanting and hitting the motor.</p> |
| Fan or light turning on or off by themselves | <p>① Confirm the circuit breaker is not malfunctioning. ② Verify the wire connections are not frayed. ③ Cut the fan power for 10 minutes then power on again. ④ All the pin wiring on the circuit board must be inserted tight and in the correct position.</p> |

Care & Cleaning

WARNING: Power off the fan before performing maintenance or cleaning the fan.

1. Check the support connections, brackets, and blade attachments twice a year. Make sure they are secure. Because of the fan's natural movement, some connections may become loose over time. It is not necessary to remove the fan from the ceiling.
2. Clean your fan periodically. Use only a soft brush or lint-free cloth to avoid scratching the finish. The plating is sealed with a lacquer to minimize discoloration or tarnishing.
3. (Optional) Apply a light coat of furniture polish to the wood blades.
4. (Optional) Cover small scratches with a light application of shoe polish.

DO NOT:

1. Use water when cleaning. Water could damage the motor, or the wood, or possibly cause an electrical shock.
2. Apply oil to your fan or motor. The motor has permanently lubricated sealed ball bearings.

FCC Statement

Note: This equipment has been tested and found to comply with the limits for a Class B digital device, pursuant to part 15 of the FCC Rules. These limits are designed to provide reasonable protection against harmful interference in a residential installation. This equipment generates, uses and can radiate radio frequency energy and, if not installed and used in accordance with the instructions, may cause harmful interference to radio communications. However, there is no guarantee that interference will not occur in a particular installation. If this equipment does cause harmful interference to radio or television reception, which can be determined by turning the equipment off and on, the user is encouraged to try to correct the interference by one or more of the following measures:

- Reorient or relocate the receiving antenna.
- Increase the separation between the equipment and receiver.
- Connect the equipment into an outlet on a circuit different from that to which the receiver is connected.
- Consult the dealer or an experienced radio/TV technician for help.

WARNING: Changes or modifications to this unit not expressly approved by the party responsible for compliance could void the user's authority to operate the equipment.