

# ASSEMBLY INSTRUCTION

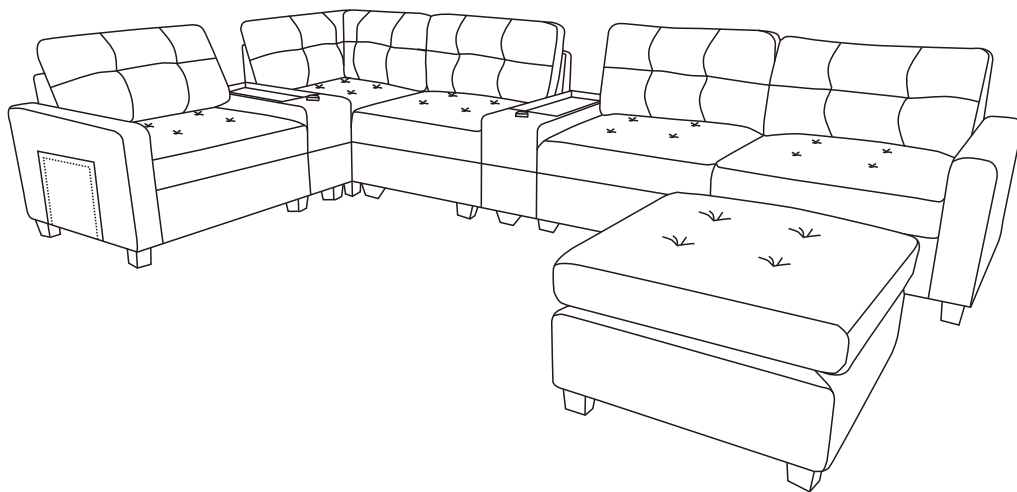

Sets often ship in multiple boxes and delivery date may vary.

## CUSTOMER SERVICE

**Questions, Missing parts, Assembly help?  
No need to return the product, we will gladly help and ship  
your replacement parts free of charge.**

# PRE-ASSEMBLY INFORMATION

**Please read this manual carefully before beginning assembly of this product. Keep this manual for future reference.**

## NOTICE

1. Please assemble it AFTER all boxes are received.
2. Please do not throw away any of the packages or the instruction until the sofa is fully assembled.
3. Please keep children away from the plastic bags or any small pieces of stuff.
4. Some key parts of our product may be stored and hidden inside of other parts. Please open any zippered or hook & loop storage compartments to take out all parts.
5. Please do not open the compressed packages until your sofa frame is completely assembled.
6. As the cushions are all vacuum compressed, there will be some wrinkles. Please give them up to 72 hours to reach its original size and the wrinkles will basically disappear.
7. DO NOT INSTALL THE SCREWS ALL THE WAY IN THE BEGINNING. Place each screw into their proper hole and use your hand to twist the screw halfway. Twist all the screws in halfway to ensure the holes will match up properly and the product is level on the ground. When everything seems fitted, then tighten the screws.
8. Do not over tighten screws and bolts to avoid stripping.



2 adults recommended



Takes about 1.5 Hours to assemble





Weight capacity of each seat: 330LBS

---

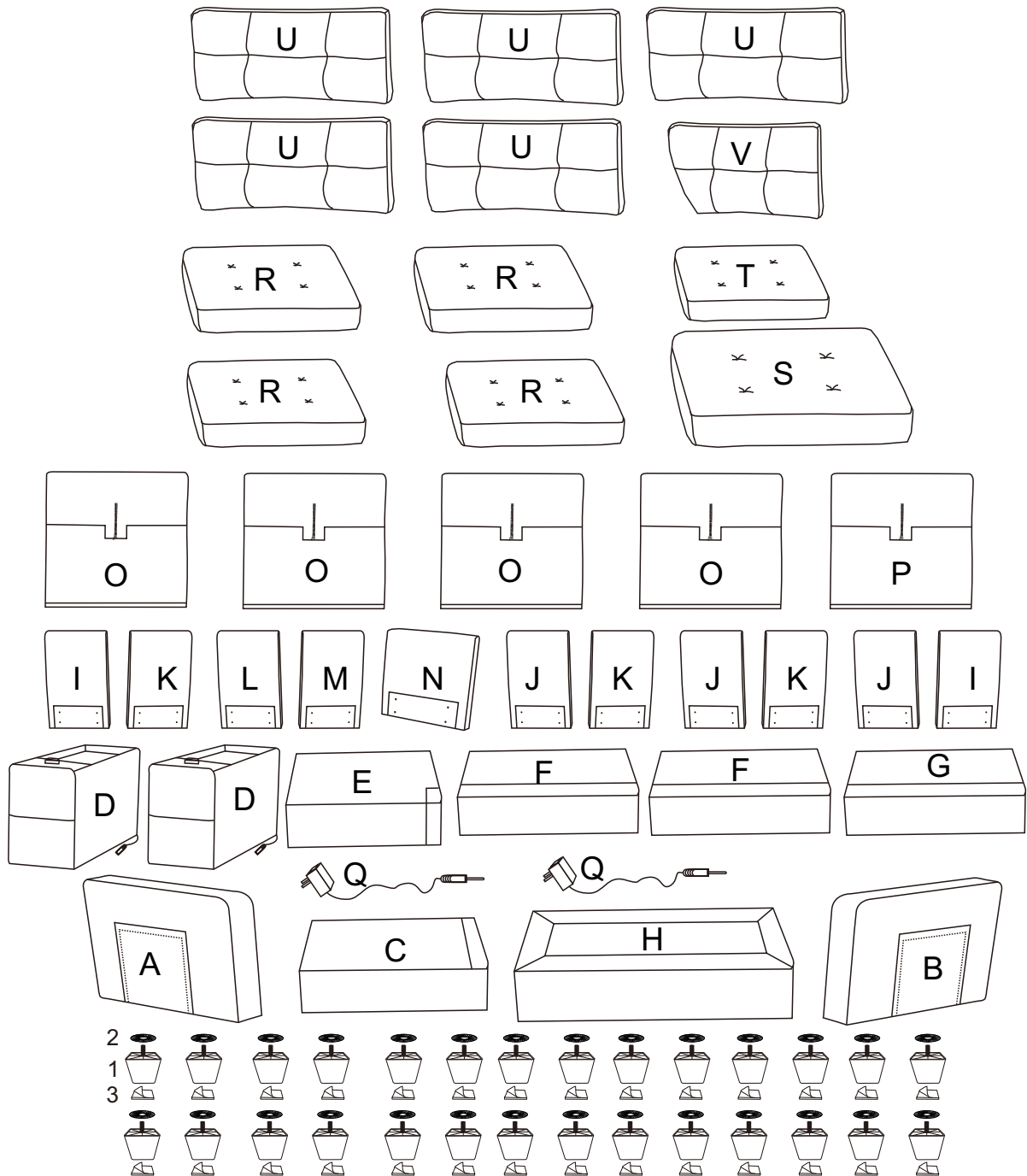
# COMPONENTS



HARDWARE			
NO	DESCRIPTION	SKETCH	QTY
4	Screws		52
5	Washer		52
6	Hex Key		1

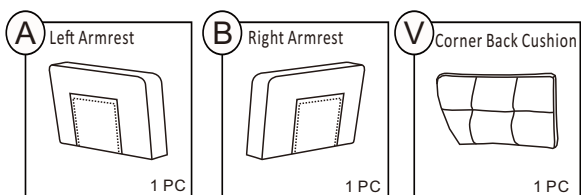
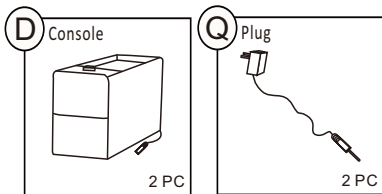
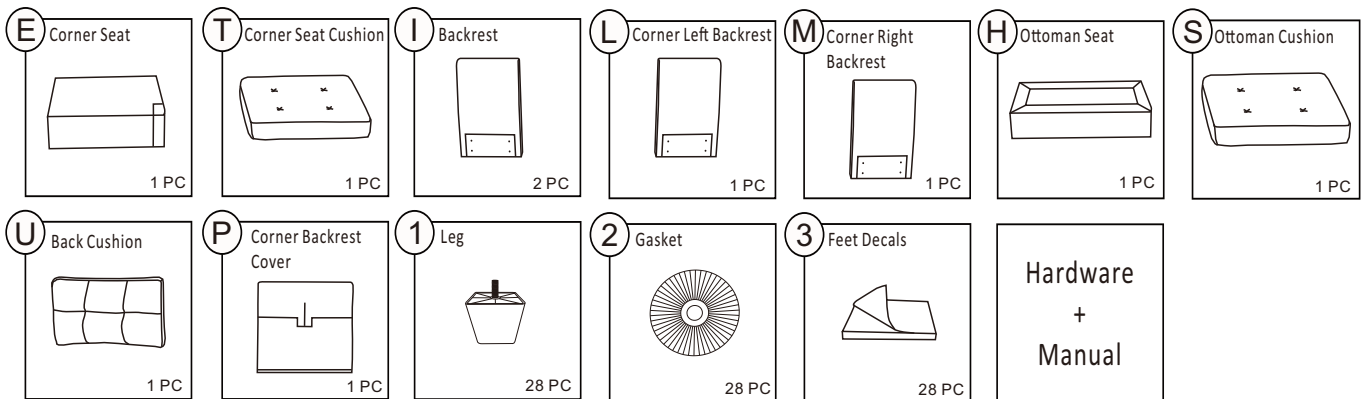
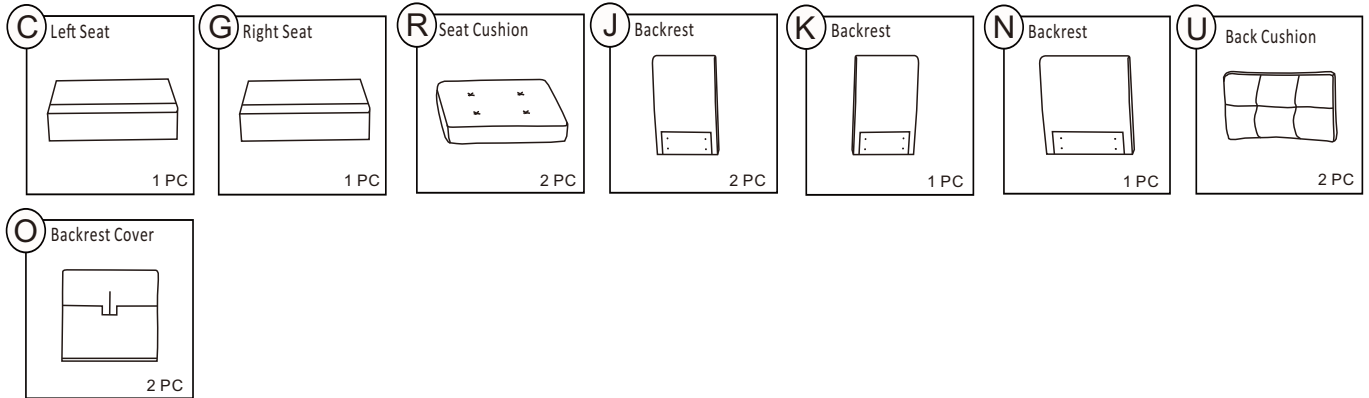
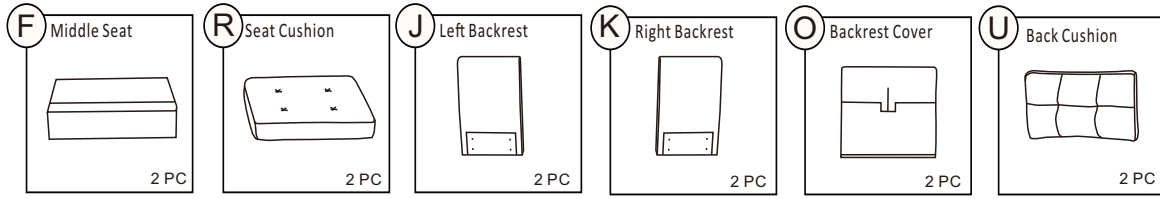

# COMPONENTS



# ASSEMBLY STEPS

## STEP 1

Connect left seat frame (C) to the backrests (I&K) with screws(4) and washers(5) by hex key(6).

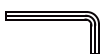
4		8
5		8
6		1

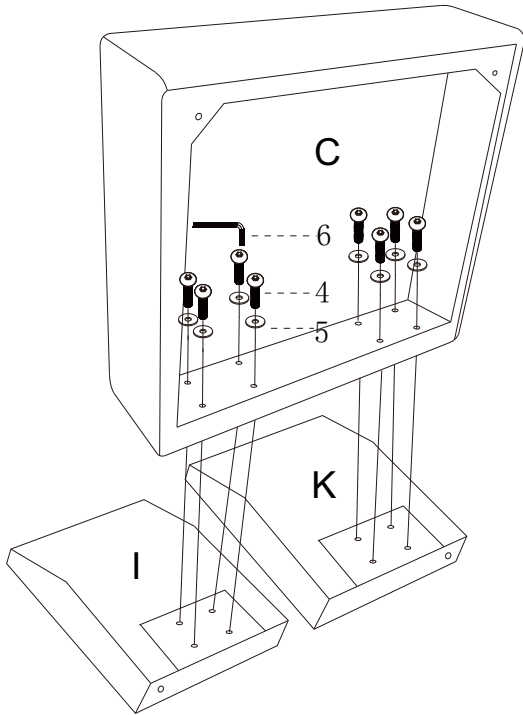





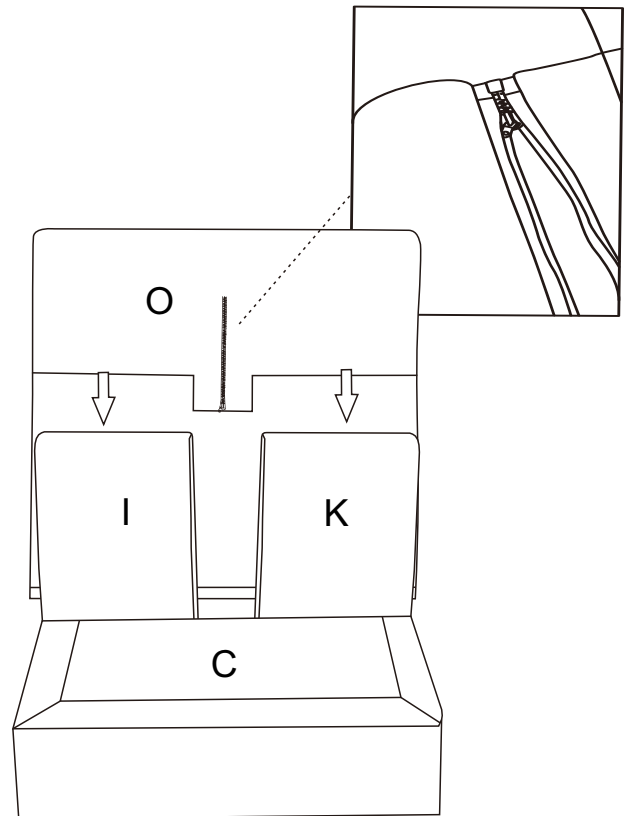

## STEP 2

Put the cover (O) on the backrest.



## STEP 3

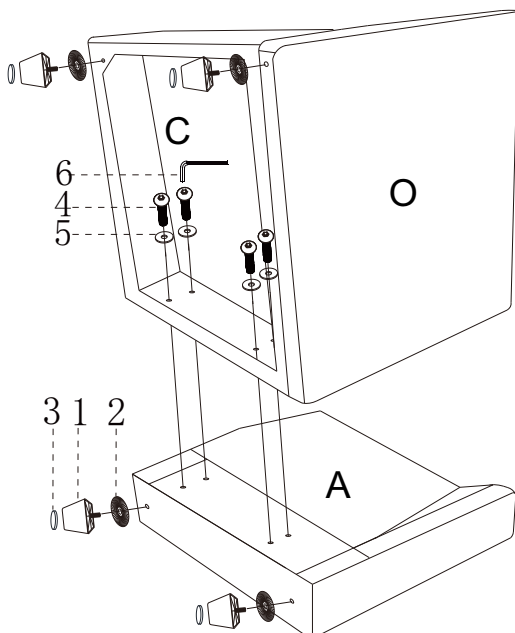

Connect left armrest (A) to seat frame (C) with screws(4) and washers(5) by hex key(6). Attach legs(1) and gaskets(2) to the seat frame. Stick the feet decals(3) onto each leg.

1		4
2		4
3		4
4		4
5		4
6		1



## STEP 4

Connect corner seat frame (E) to the backrests (L&M) with screws(4) and washers(5) by hex key(6).

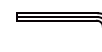
4		8
5		8
6		1

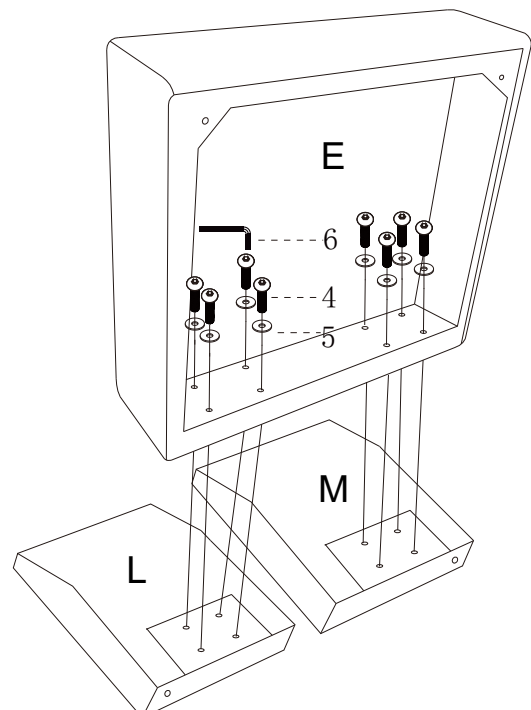

# ASSEMBLY STEPS

## STEP 5 Put the cover (P) on the backrest.

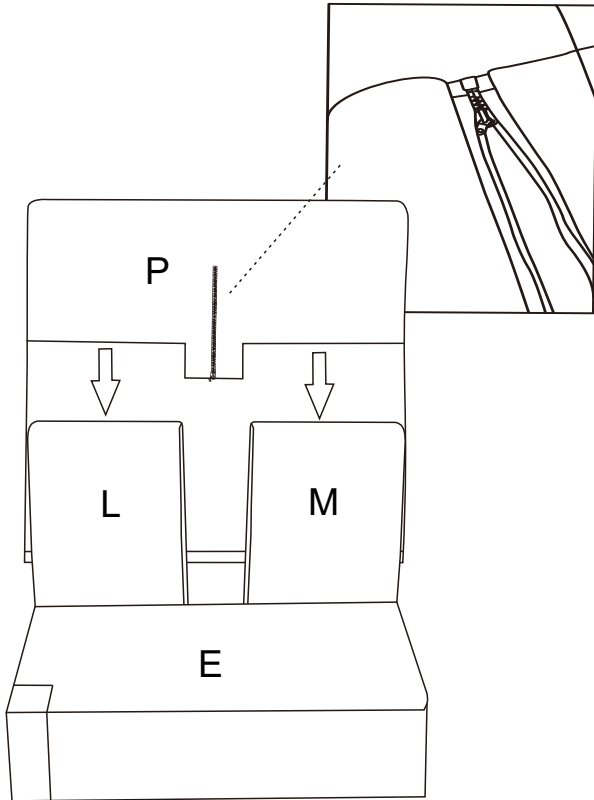

## STEP 6

Connect corner backrest (N) to seat frame (E) with screws(4) and washers(5) by hex key(6). Attach legs(1) and gaskets(2) to the seat frame. Stick the feet decals(3) onto each leg.

1		4
2		4
3		4
4		4
5		4
6		1

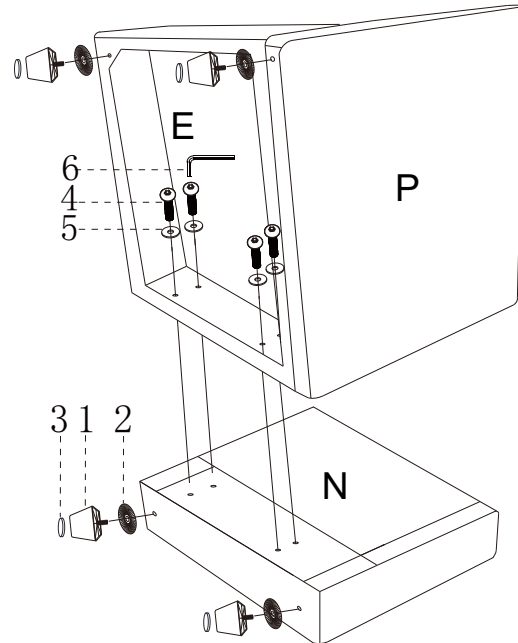

## STEP 7

Connect middle seat frame (F) to the backrests (J&K) with screws(4) and washers(5) by hex key(6).

4		16
5		16
6		1

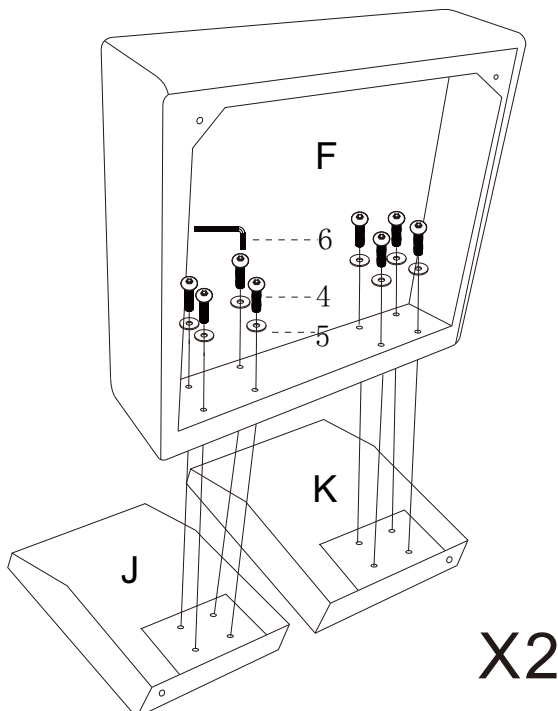

## STEP 8

Put the cover (O) on the backrest. Attach legs(1) and gaskets(2) to the seat frame. Stick the feet decals(3) onto each leg.

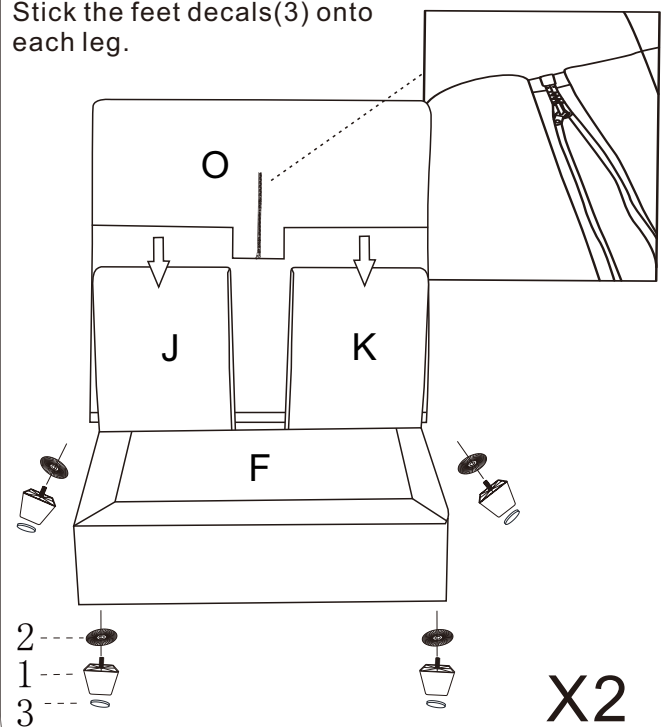

1		8
2		8
3		8



# ASSEMBLY STEPS

## STEP 9

Connect right seat frame (G) to the backrests (J&I) with screws(4) and washers(5) by hex key(6).

4		8
5		8
6		1

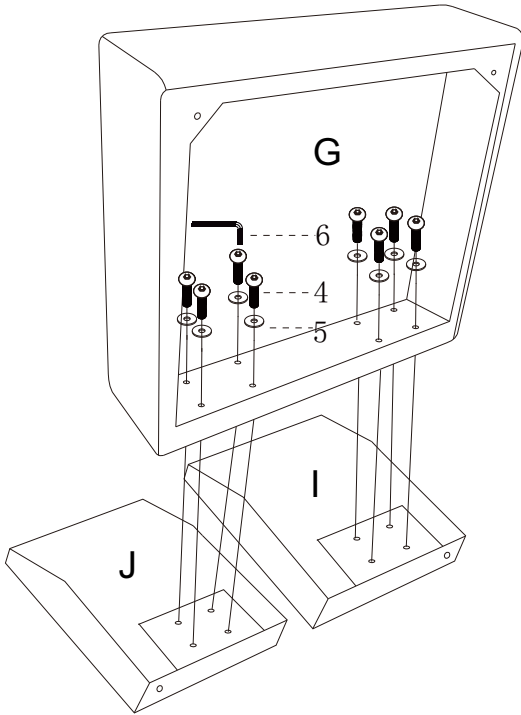





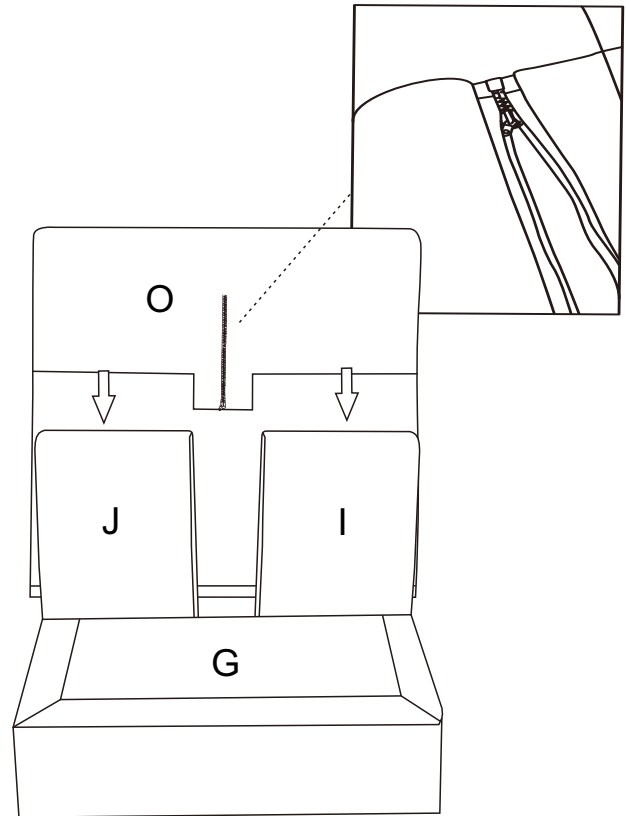

## STEP 10

Put the cover (O) on the backrest.



## STEP 11

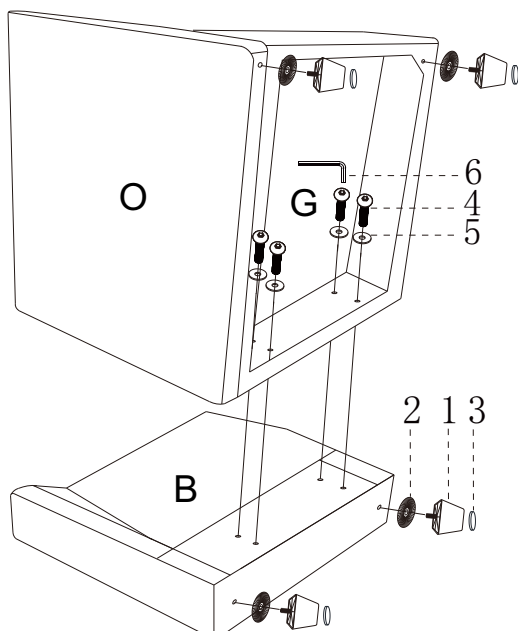

Connect right armrest (B) to seat frame (F) with screws(4) and washers(5) by hex key(6). Attach legs(1) and gaskets(2) to the seat frame. Stick the feet decals(3) onto each leg.

1		4
2		4
3		4
4		4
5		4
6		1



## STEP 12

Attach legs (1) and gaskets (2) to the consoles (D) and ottoman seat (H). Stick the feet decals (3) onto each leg.

1		8
2		8
3		8

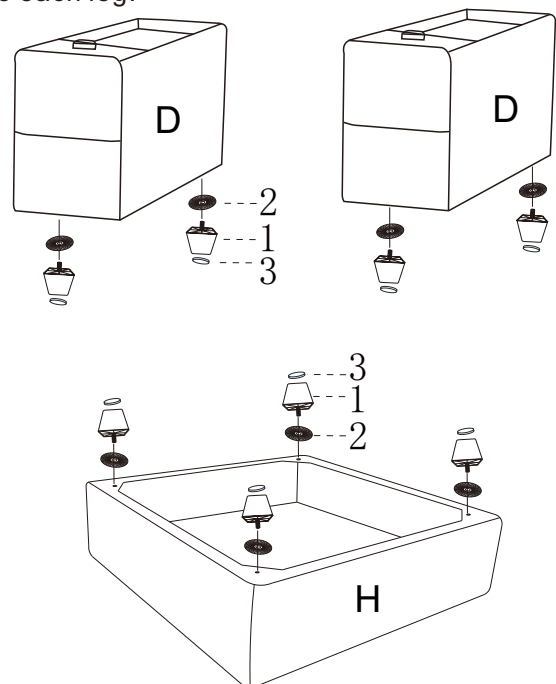

**STEP 13** Connect the left seat frame, corner seat frame, two middle seat frames, two consoles and right seat frame with inserts.

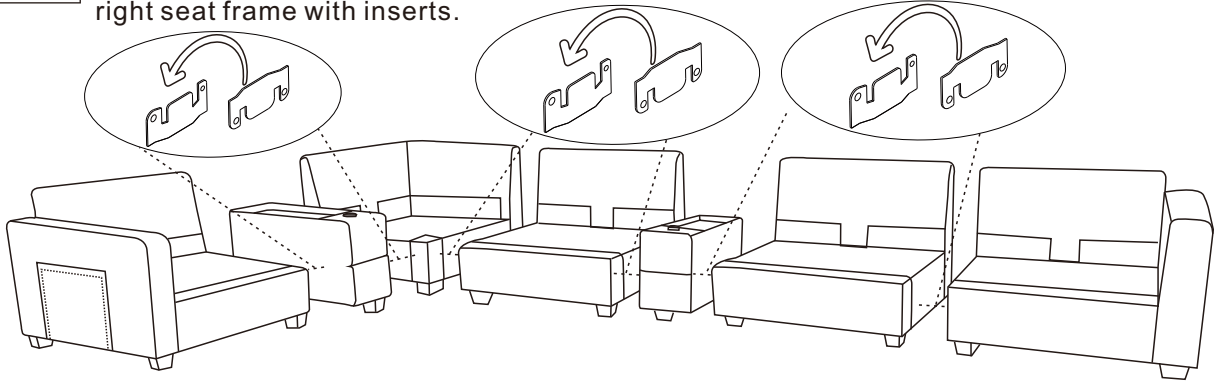

**STEP 14** Open the vacuum bag and take the cushions (R/S/T/U/V) out. To restore the original shape, follow the steps bellow.

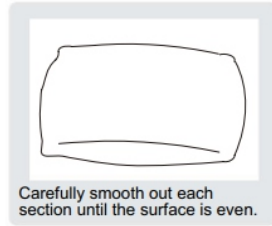
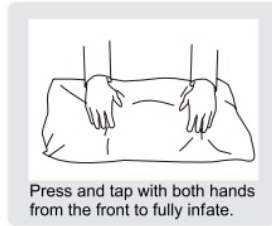
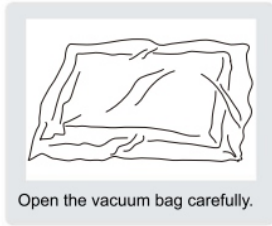

After packing up, place them in somewhere dry and venslated. After about 72-96 hours. It can be restored to the best use condition.

**STEP 15** Put the cushions (R, S, T, U & V) on the sofa.

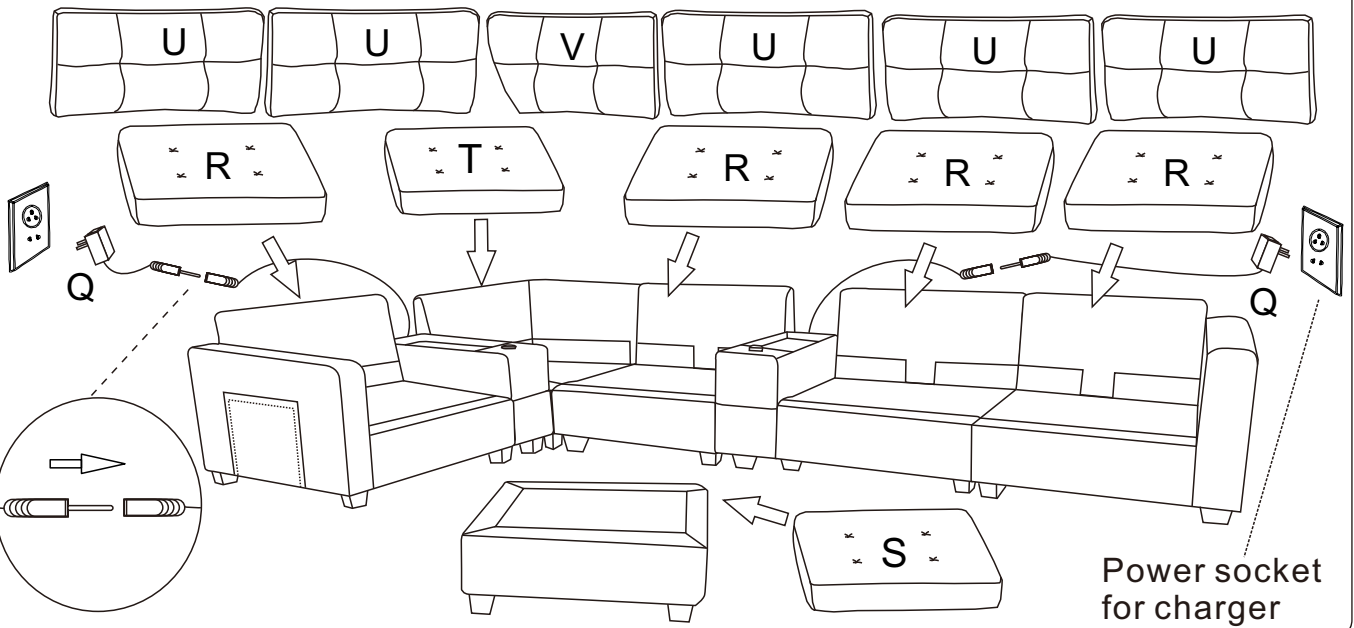

**STEP 16** Complete

