

# Assembly Instructions

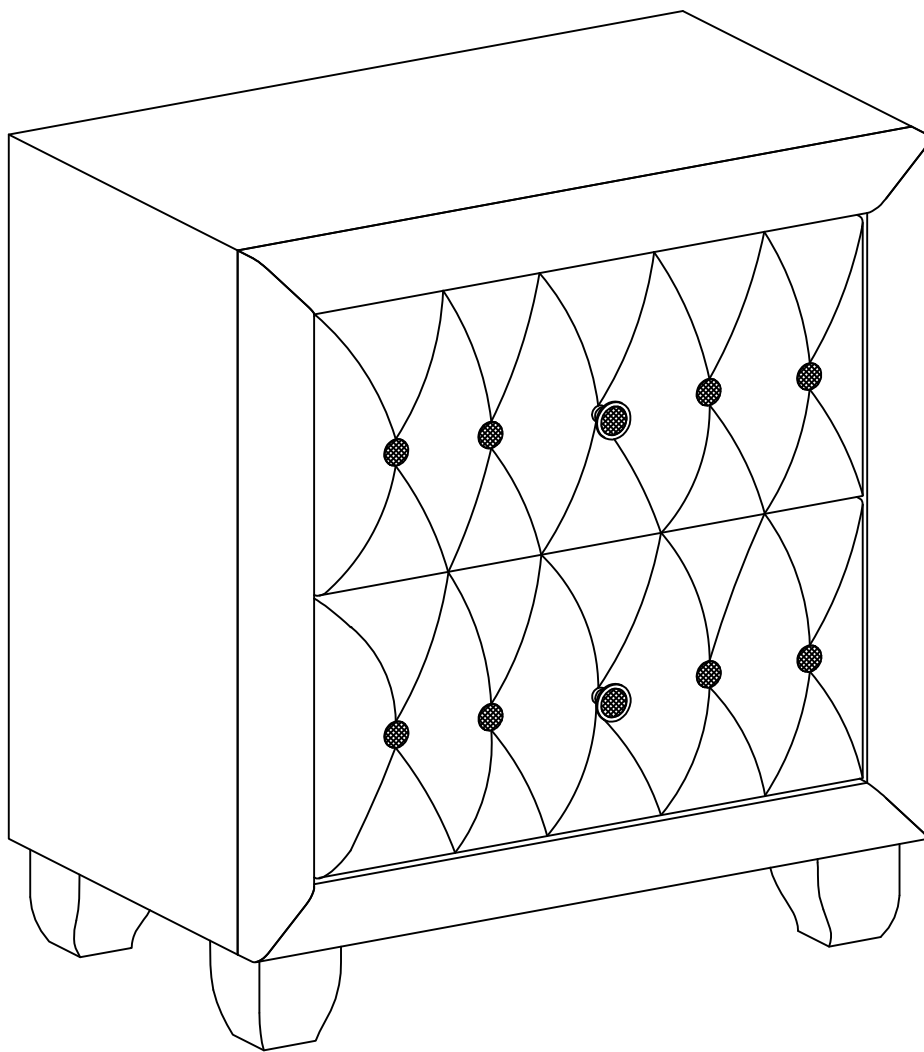

ITEM: F1979 NIGHTSTAND





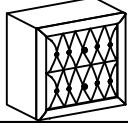

# Assembly Instructions

ITEM: F1979 NIGHTSTAND

## PARTS LIST

NO	DECS	PHOTO	Q'TY
A	Upholstery Nightstand		1 pc
B	Legs		4 pcs

## HARDWARE LIST

NO	DECS	PHOTO	Q'TY
1	Long Bolts Ø5/16" x 100mm		4 pcs
2	Spring washer <math>\varnothing 5/16''</math>		4 pcs
3	Flats washer <math>\varnothing 5/16''</math>		4 pcs
4	Allen key 4mm		1 pc

### Step 1

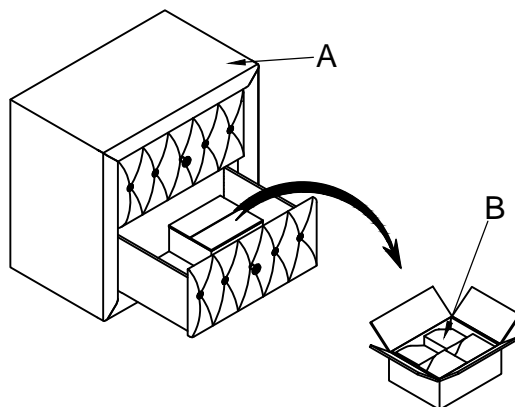

### Step 2

