

Assembly Instructions

Caution : You must read this before you proceed.

BASKET





! WARNING:



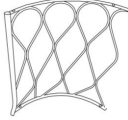

Thank you for purchasing the Hanging Chair. Please read below before you proceed.

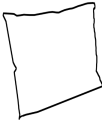
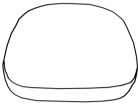
1. Not intended for use by children 12 years of age or younger.
2. This is a hanging chair, not a swing chair.
3. Do not swing on or in the chair. It could cause the product to tip over, resulting in possible injury.
4. This chair basket is not a toy.
5. No mounting hardware kit included.
6. Professional installation required.

Parts List

No.	Picture	Description	Qty
A		Top	1
B		Left Back	1
C		Right Back	1
D		Seat	1
E		Back Cushion	2
F		Seat Cushion	1

Hardware

①		Bolt(M8*30MM)	5
②		Bolt(M8*20MM)	5
③		Nut((M8)	9
④		Allen Wrench(M8)	1
⑤		Wrench(M8)	1

Chair Basket intended for use with Iron Stand

	Iron Stand (Separate Package)	1
---	-------------------------------	---

Assembly preparation

Before Beginning Assembly:

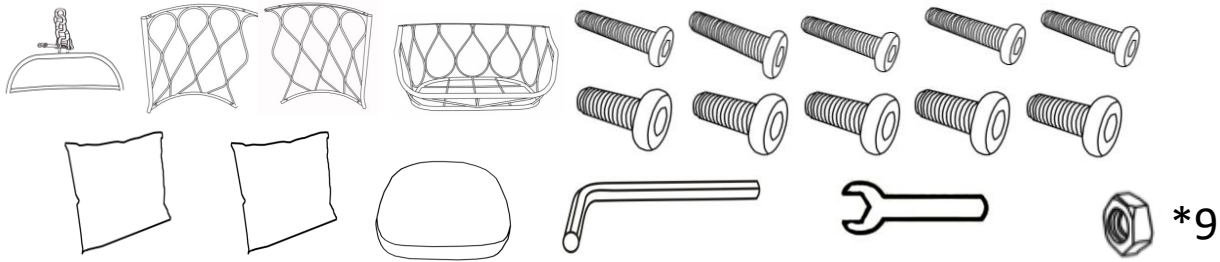

- Read instructions, cover to cover-



- Have 2 adults on hand for assembly-



- Do not assemble on flooring or carpet-



- Assemble on a clean non-marring surface (packing foam)-



- Save all packaging until finished-

Assembly Steps

Overview

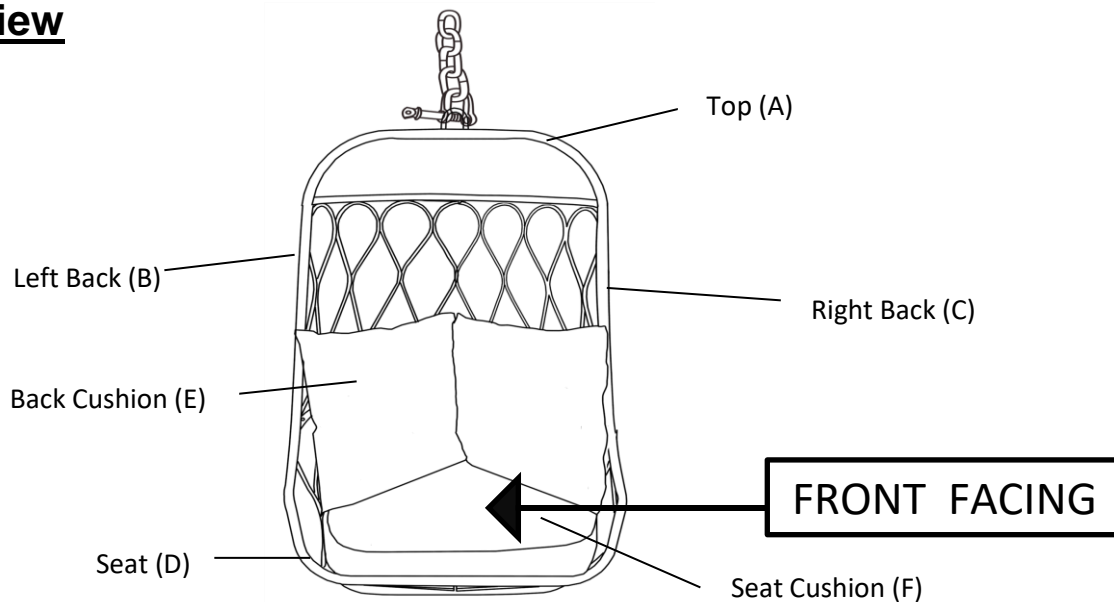

This Basket has multiple parts and may require up to 30 minutes to assemble. To give you an overview of the Basket parts, the above picture is to help you put the various parts into perspective. Please read through the instructions below to familiarise yourself with the parts and steps before assembly.

Step 1

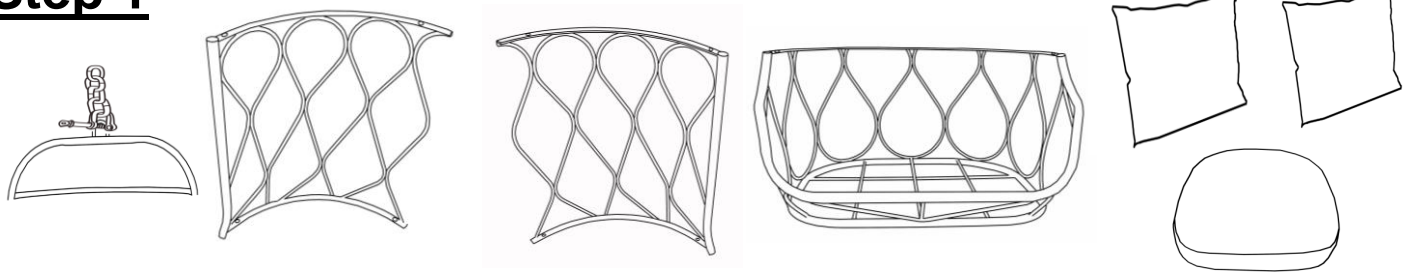

Unpack and place all parts on a clean, soft surface.

Step 2

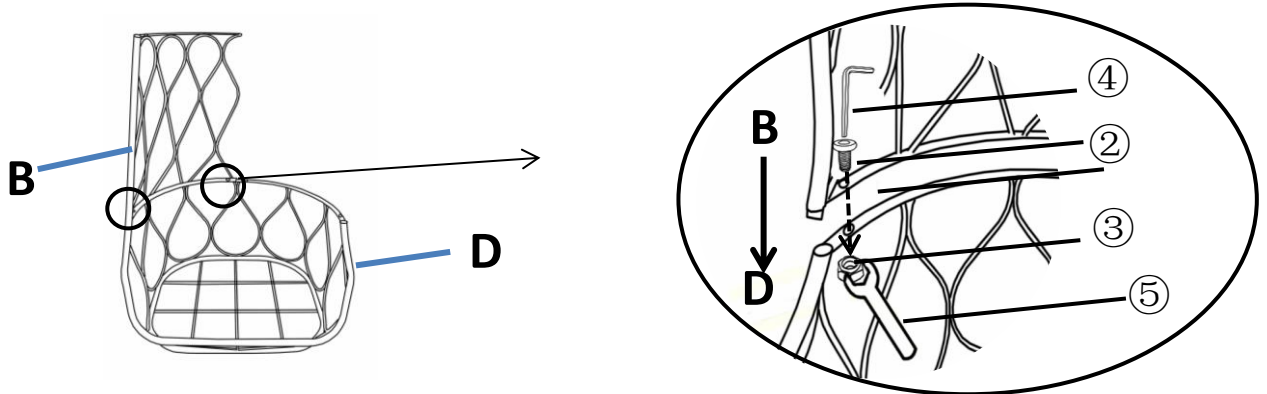

Attach the Left Back(B) to the Seat (D) using Bolts(2) and Nuts(3).

Use the Wrench(5) to tighten the Nuts(3) while fastening the Bolts(2) with the Allen Wrench(4).

Do not overtighten.

Step 3

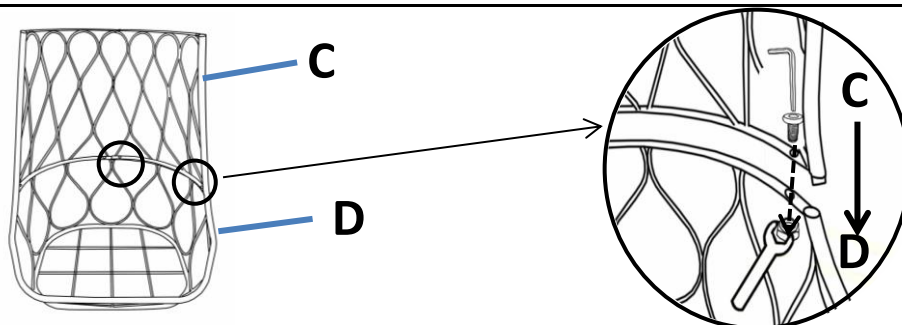

Repeat Step 2 to assemble the Right Back(C) to the Base(D)

Do not overtighten.

Step 4

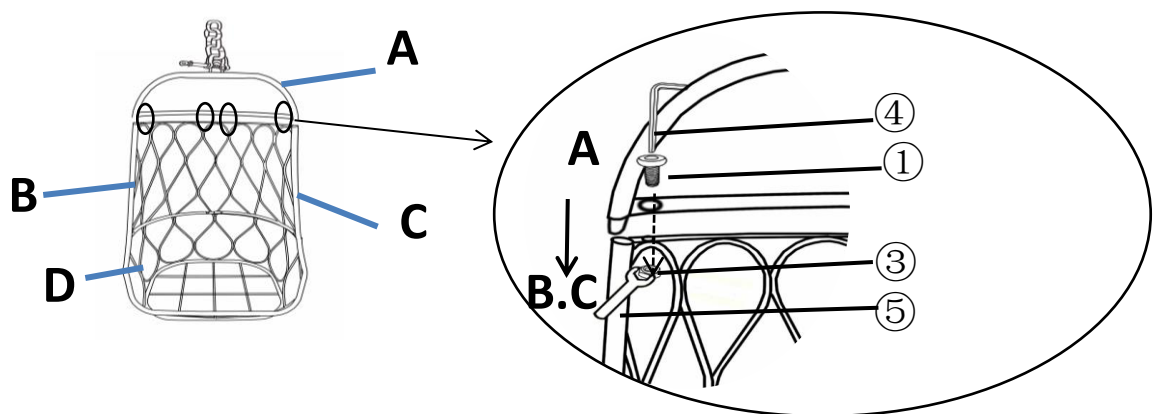

On completion of Step 3, proceed to connect the Basket Top(A).

Use the Bolts(1) and Nuts(3) as in Step 2 above, to complete this Step 4 assembly.

All the Bolts and Nuts must be tightened now.

Step 5

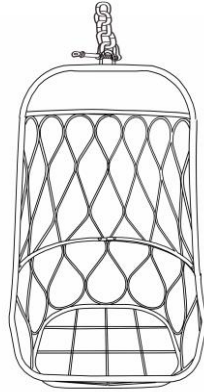

Fully tighten all Nuts and Bolts.

Step 6

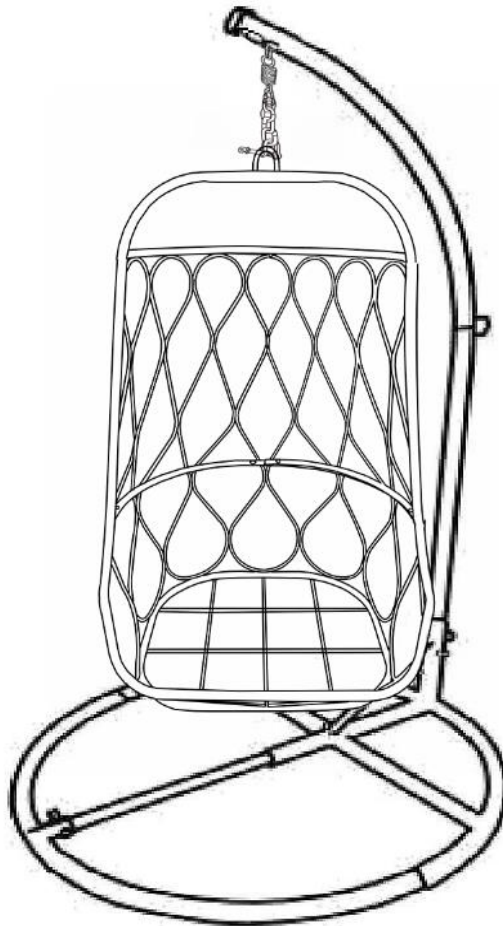

Lift the Basket and hang the Iron Chain on the Spring of the Hanging Chair Base.

Step 7

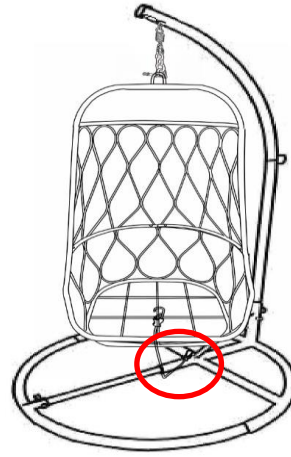
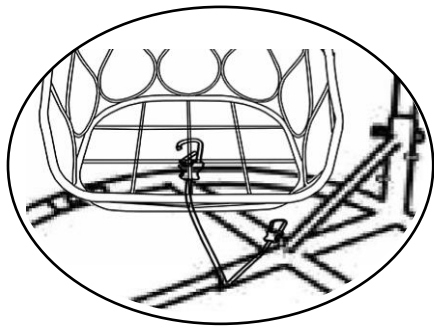

Lift the chair basket and hook the Iron Chain(A) to the Iron Stand, and fasten the Safety strip as shown above.

Note: This step should be completed with 2 adults

Step 8

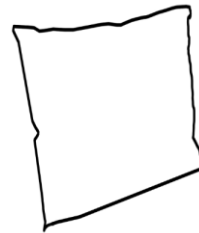

E

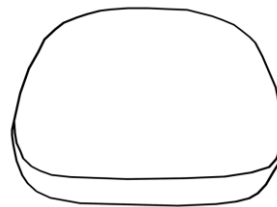









F

Put the Cushion(E) and (F) on the Chair, and Adjust the Chain link to your preferred Seat Height.

Your Hanging Chair-Basket is ready for use.

Care & Maintenance

- ⊘  ● Do not put hot items directly on furniture surface.
- ⊘  ● Do not clean furniture with harsh cleansers or polish.
- ✓  ● To obtain the longest lifespan of your outdoor products, minimizing exposure to direct sunlight is recommended.
- ⊘  ● Children should not climb or jump on the furniture.
- ⊘  ● Do not write on furniture without a padded barrier to protect the surface.
- ✓  ● To obtain the longest lifespan of your outdoor products, avoid extended and lengthy exposure to rain, snow, and direct sunshine. Whenever possible cover the product and /or place under patio or awnings.
- ⊘  ● Not for commercial use. For residential use only.
- ⊘  ● Stains may be removed with mild soap solution and damp cloth.
- ✓  ● Dust and Pick-up spills: Use a Clean, non-colored, lint free cloth.