

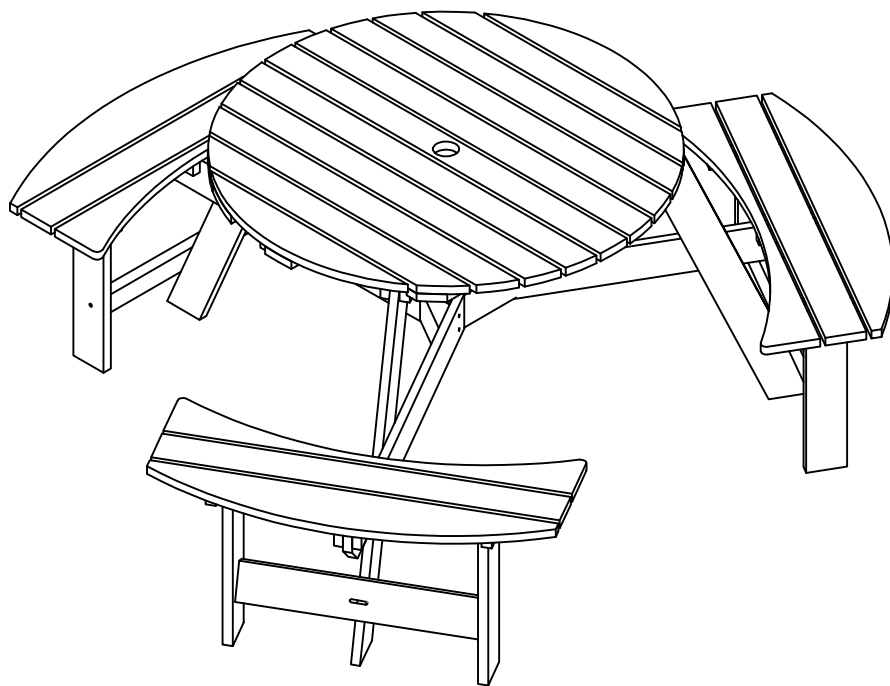









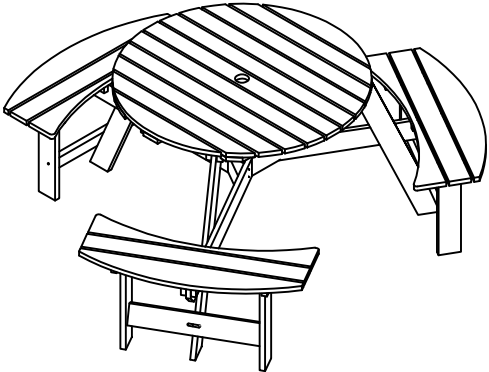



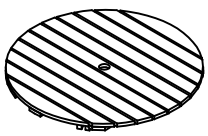



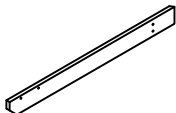

# Outdoor Picnic Table Instrucyion Manual

## (6-Person)



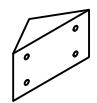



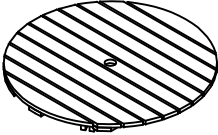
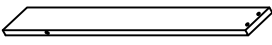

# Parts List

Carefully remove the parts from the carton, verify that you have received all components, and place them individually on a soft cloth to prevent scratches or other damage.

			A		12PC
			B		3PC
			C		12PC
			D		3PC
①		1PC	E		15PC
②		3PC	F		15PC
			G		30PC
③		3PC	H		1PC
④		3PC	I		1PC
⑤		6PC	J		1PC
			K		21PC
⑥		3PC	L		27PC
			M		27PC
⑦		3PC	N		6PC



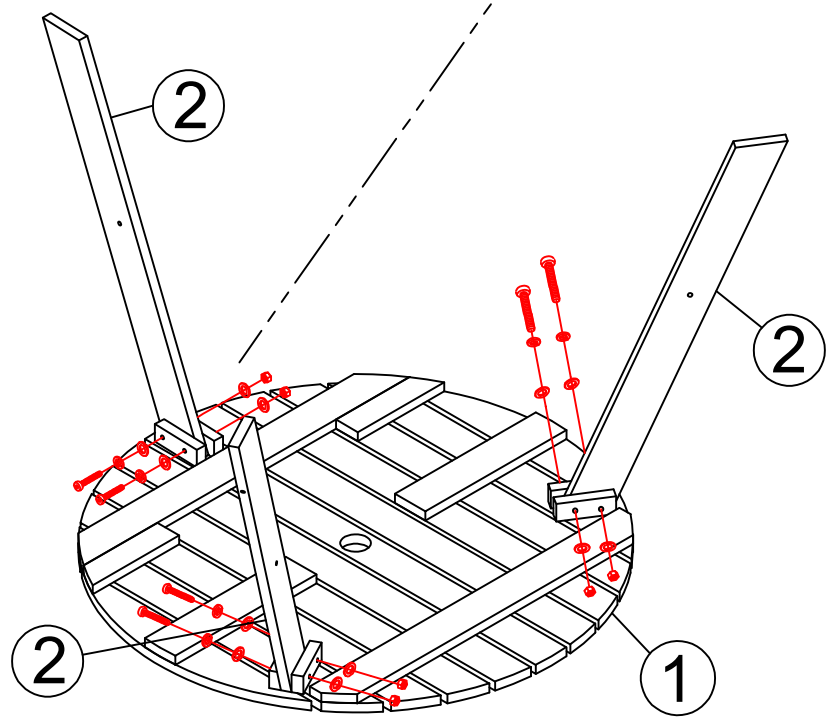
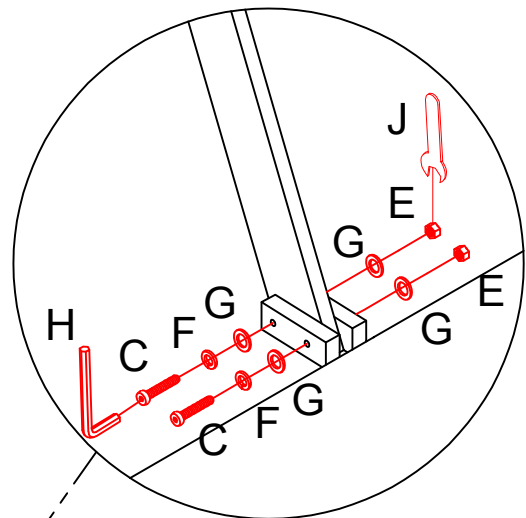

# Step 1: Install the table top and legs

①	②	C	E	F	G	H	J
							
1PC	3PC	6PC	6PC	6PC	12PC	1PC	1PC

As shown in the picture, fix the ② table leg with the screw through the slot.

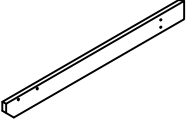

## Step 2: Install the tripod





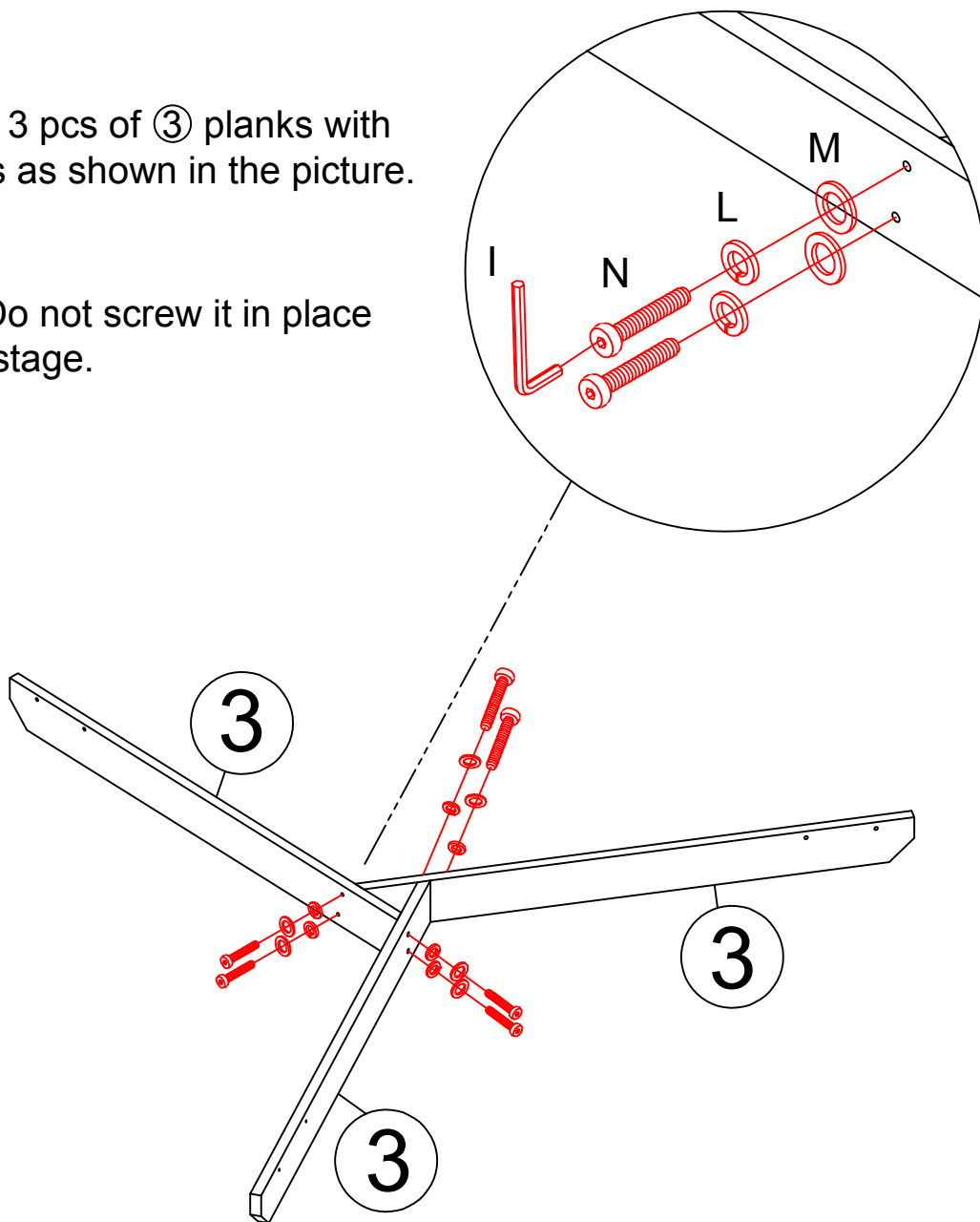

③	N	L	M	I
				
3PC	6PC	6PC	6PC	1PC

Attach 3 pcs of ③ planks with screws as shown in the picture.

Note: Do not screw it in place at this stage.





### Step 3: Fix the table legs and tripod with screws as shown in the picture.

B	D	E	F	G	H	J
						
3PC	3PC	3PC	3PC	6PC	1PC	1PC

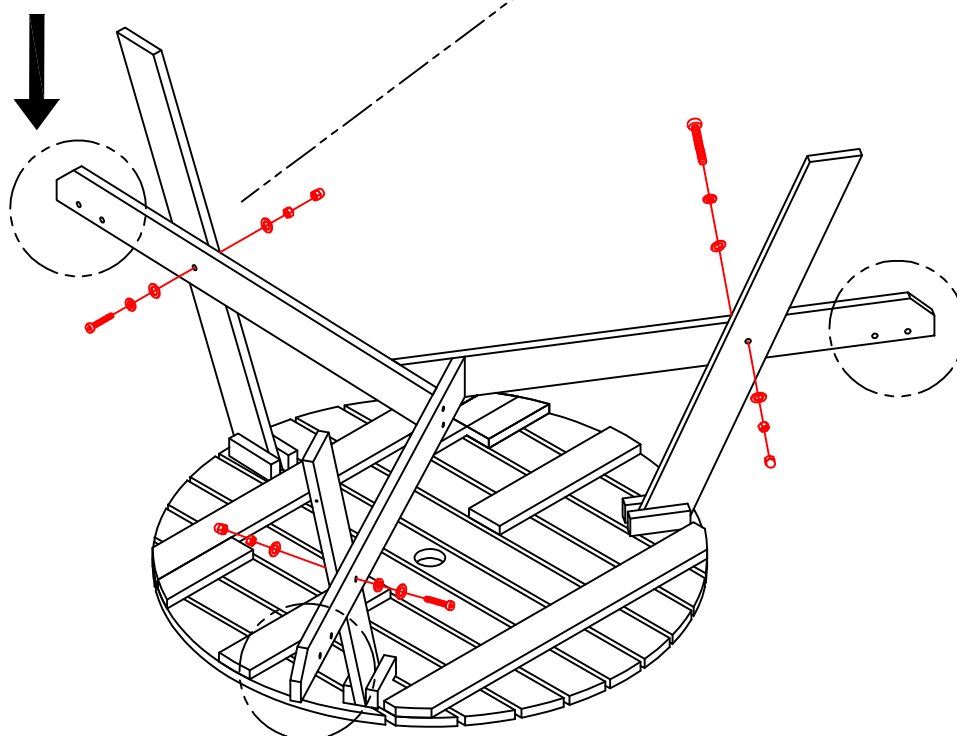
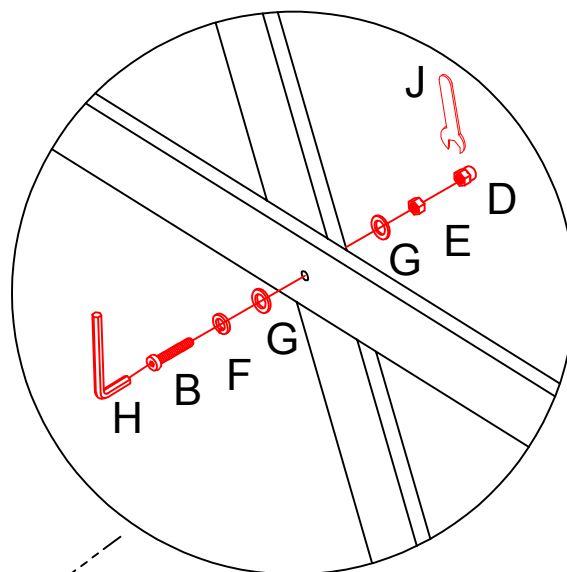
Note: As shown in the picture, the tripod must be placed in the same direction to ensure a smooth assembly. The tripod must be oriented towards the same side as shown in the picture to ensure smooth assembly.



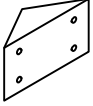



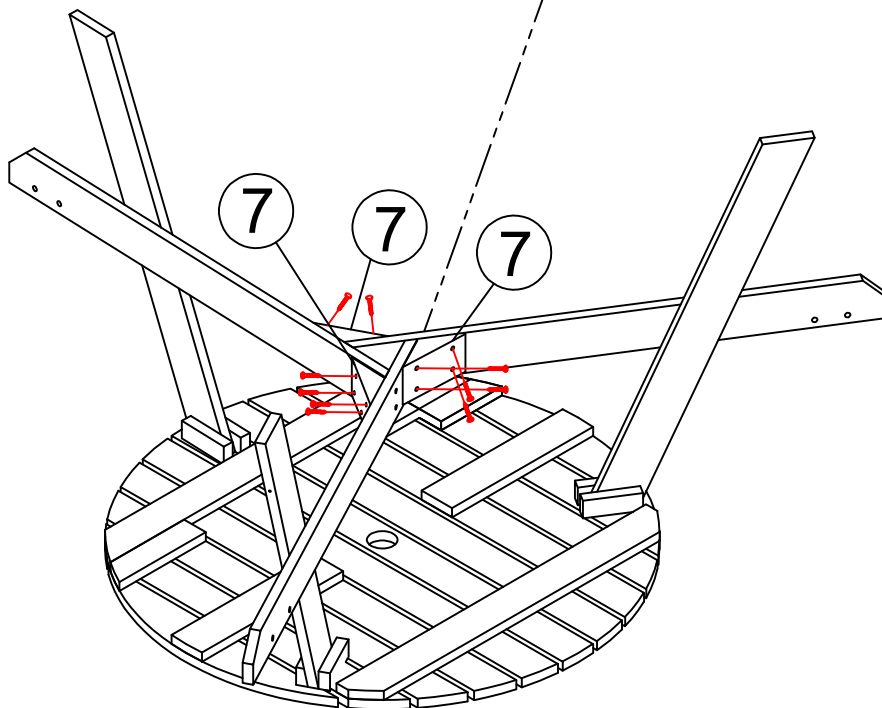
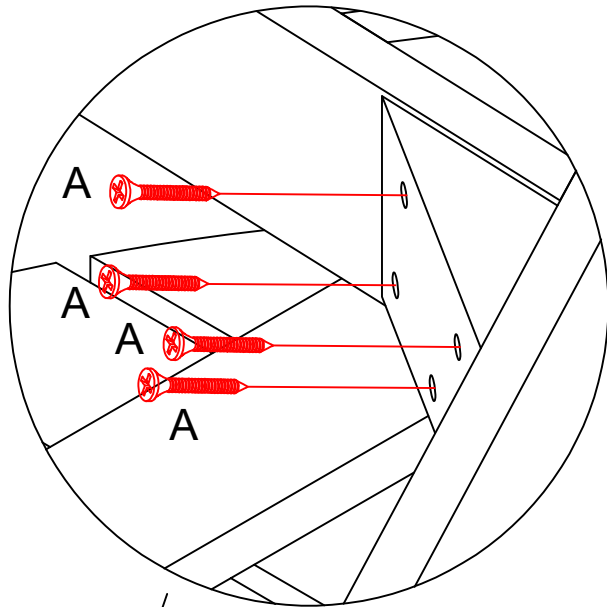

Step 4: Secure the triangular wood block to the tripod with screws as shown.

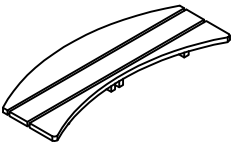
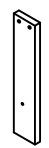
⑦	A
	
3PC	12PC







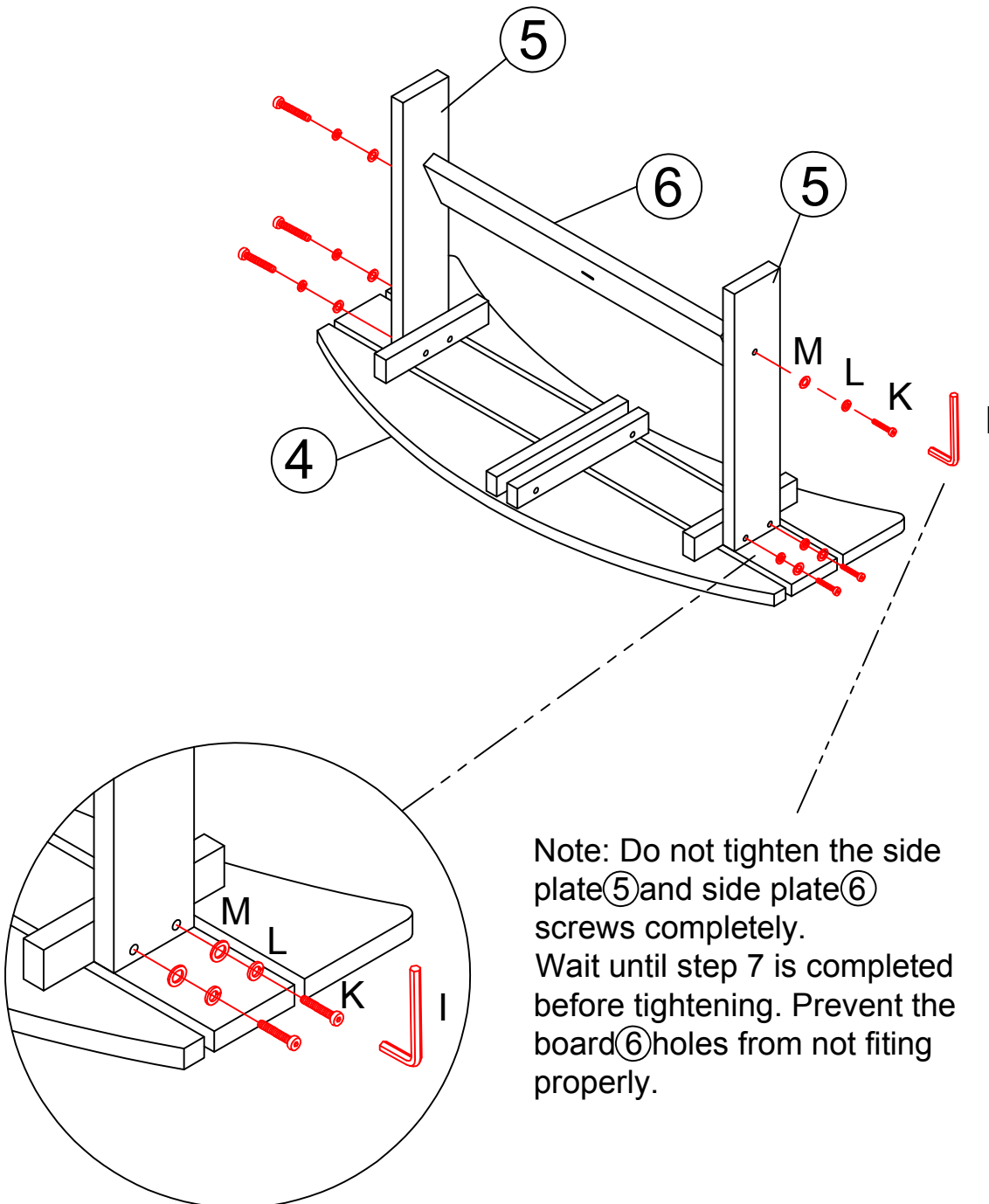

# Step 5: Fix the stool with screws.

④	⑤	⑥	K	L	M	I
						
3PC	6PC	3PC	18PC	18PC	18PC	1PC





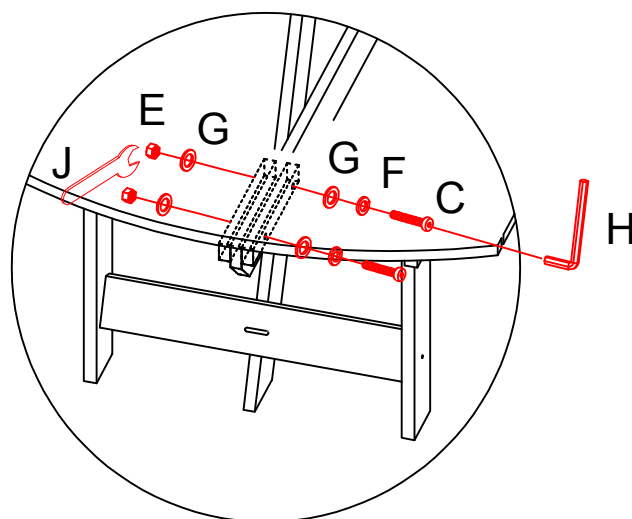
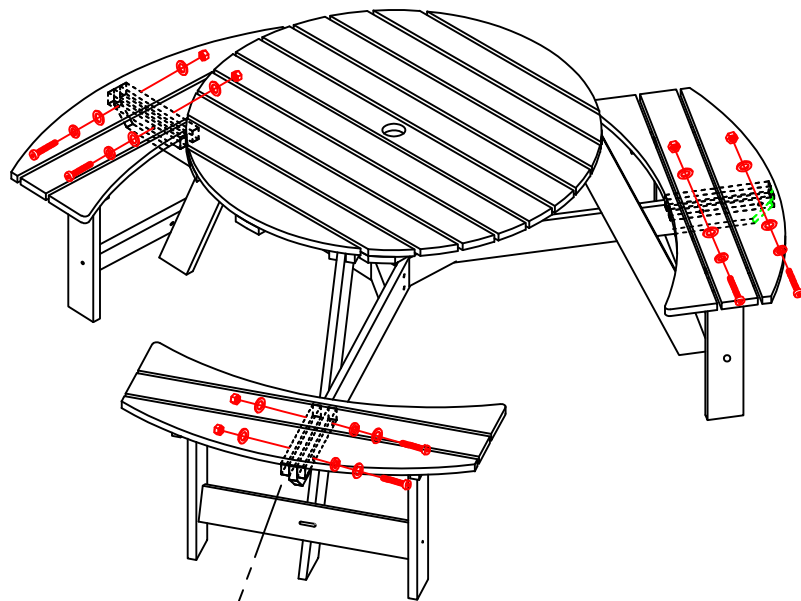

# Step 6: Attach the stool to the tripod.

C	E	F	G	J	H
					
6PC	6PC	6PC	12PC	1PC	1PC



## Step 7: Fix table legs and stools with screws.

K	L	M	I
			
3PC	3PC	3PC	1PC

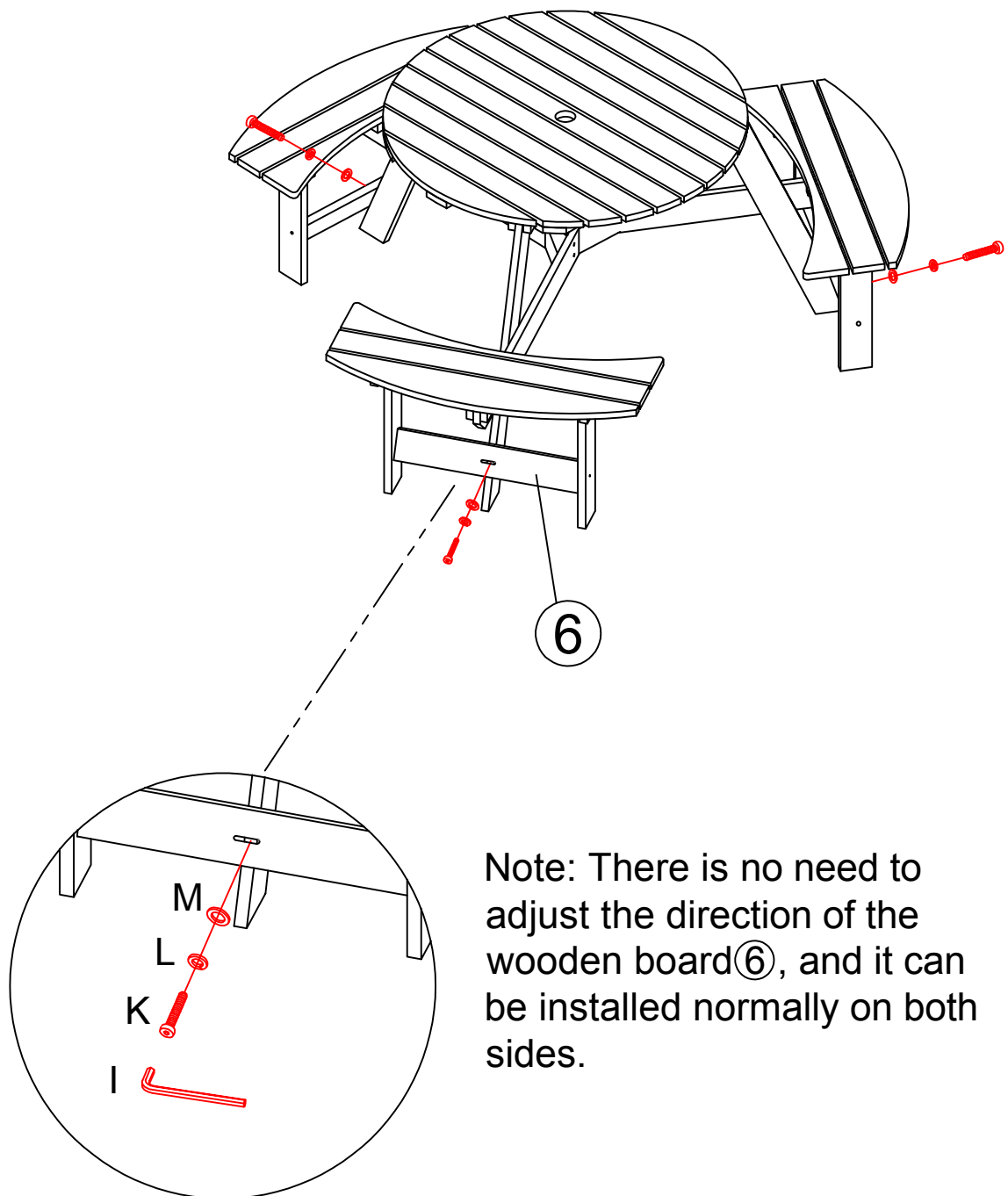

We sincerely thank you for trusting our service and our products, and may this product add enrichment to your home. We guarantee that the product has undergone strict quality inspection and meticulous packaging.

.This manual contains important information and keep it properly.

. Please avoid harsh, corrosive and abrasive cleaners.

.Keep dry and avoid damp environments.