

**HOUSE BED**  
**ASSEMBLY INSTRUCTIONS**  
SKU: N709P173466

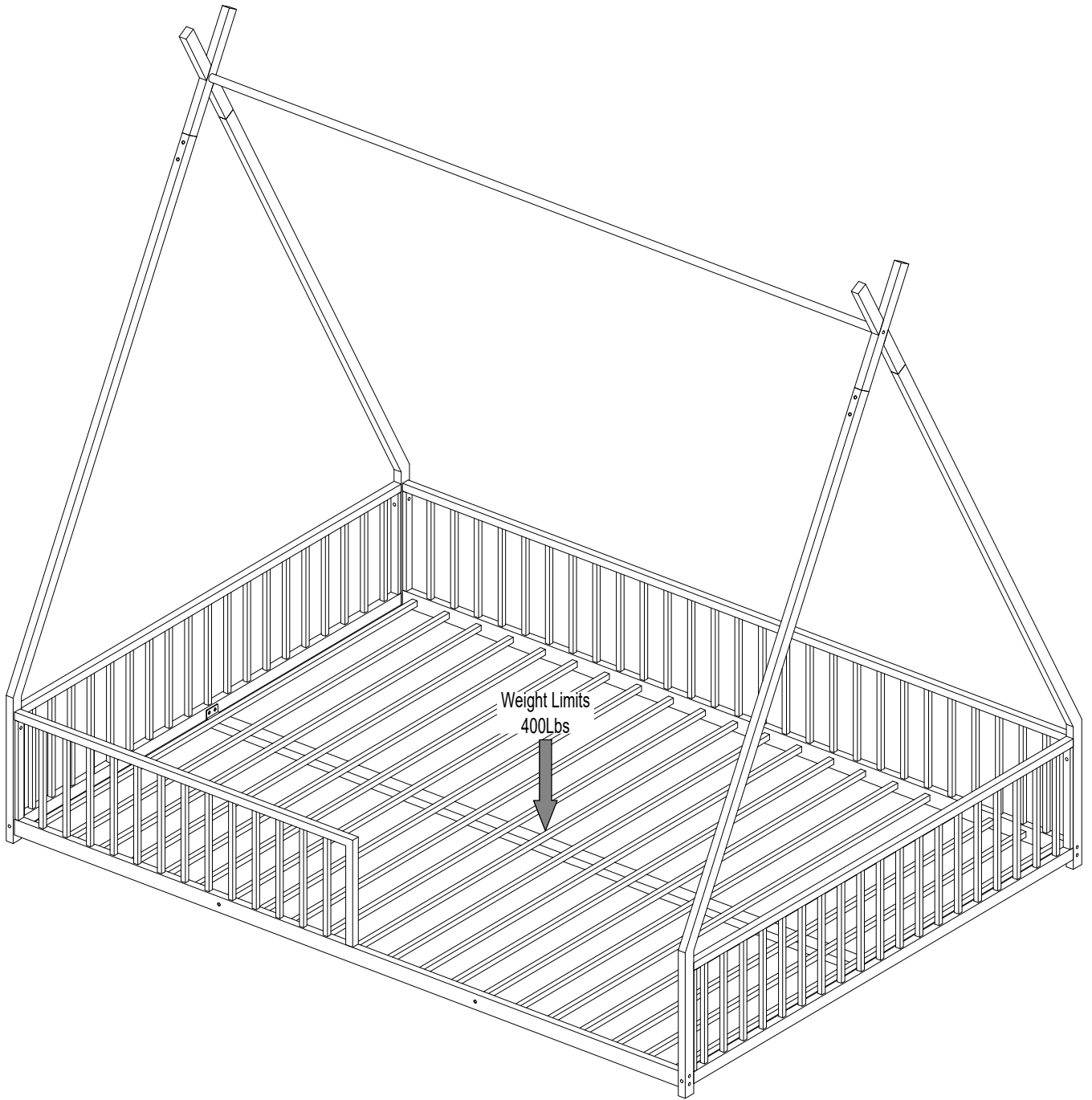

**HOUSE BED**  
**ASSEMBLY INSTRUCTIONS**  
SKU: N709P173466

**SAFETY WARNING AND GENERAL NOTES**

- Do not use substitute parts. Contact the manufacturer or dealer for replacement parts.
- Keep these instructions for future reference.
- We recommend assembling your bed on the shipping carton to protect your floor or carpet.
- Be certain all staples are out of the box before beginning assembly on the shipping carton.
- Replacement Parts:  
Replacement Parts, including additional guardrails, may be obtained from any of our (GIGACLOUD TECHNOLOGY (USA) INC.) dealers

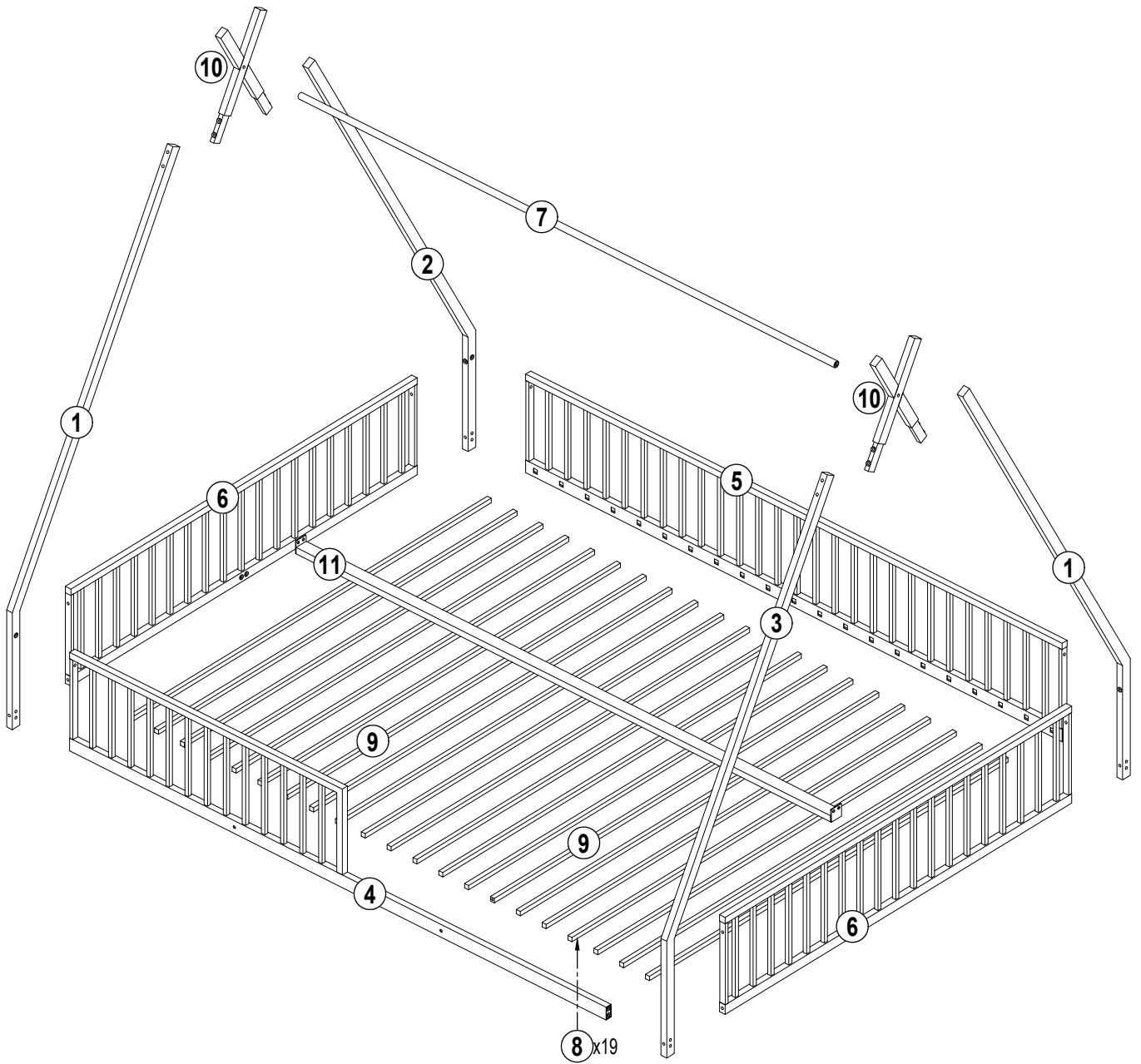

**PART LIST**

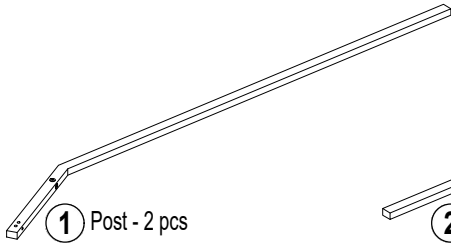

① Post - 2 pcs

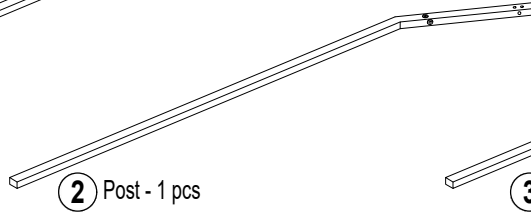

② Post - 1 pcs

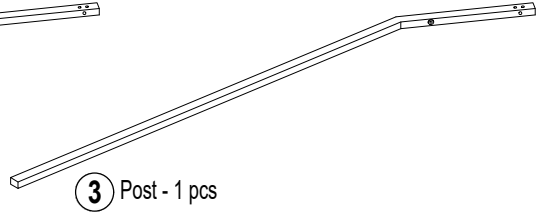

③ Post - 1 pcs

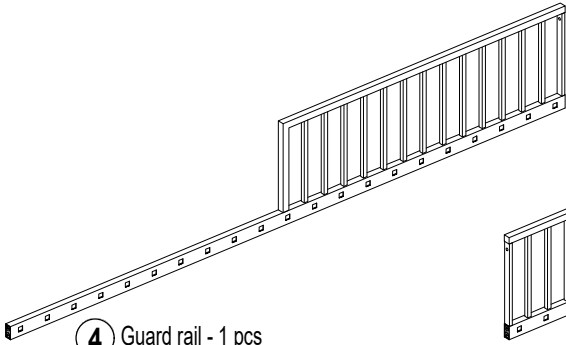

④ Guard rail - 1 pcs

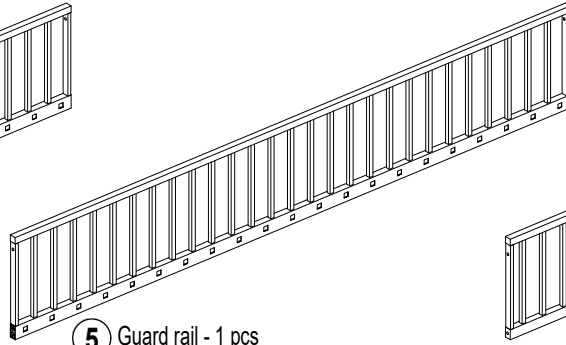

⑤ Guard rail - 1 pcs

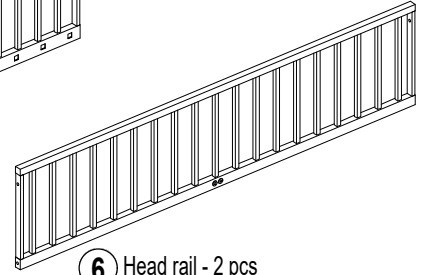

⑥ Head rail - 2 pcs

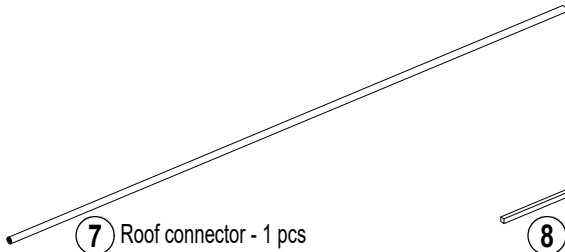

⑦ Roof connector - 1 pcs

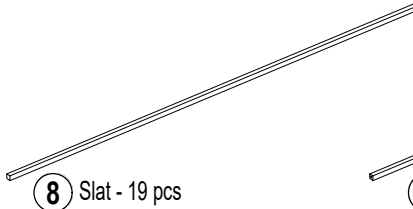

⑧ Slat - 19 pcs

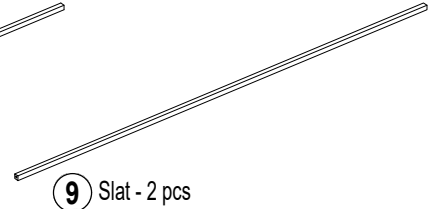

⑨ Slat - 2 pcs

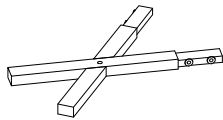

⑩ Roof connector  
2 pcs

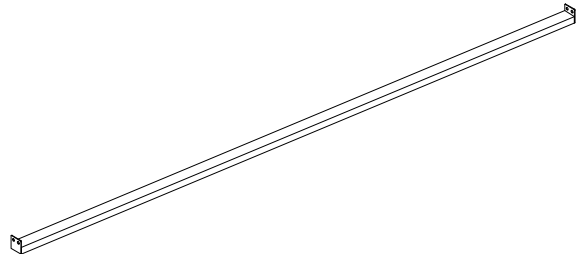

⑪ Support - 1 pcs

**HARDWARE LIST**

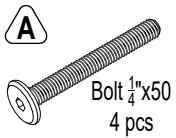

Bolt  $\frac{1}{4}$ "x50  
4 pcs

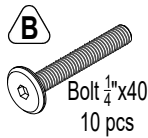

Bolt  $\frac{1}{4}$ "x40  
10 pcs

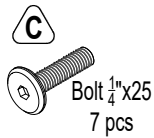

Bolt  $\frac{1}{4}$ "x25  
7 pcs

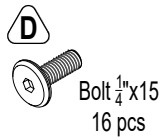

Bolt  $\frac{1}{4}$ "x15  
16 pcs

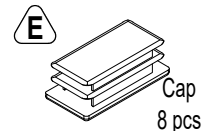

Cap  
8 pcs

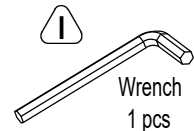

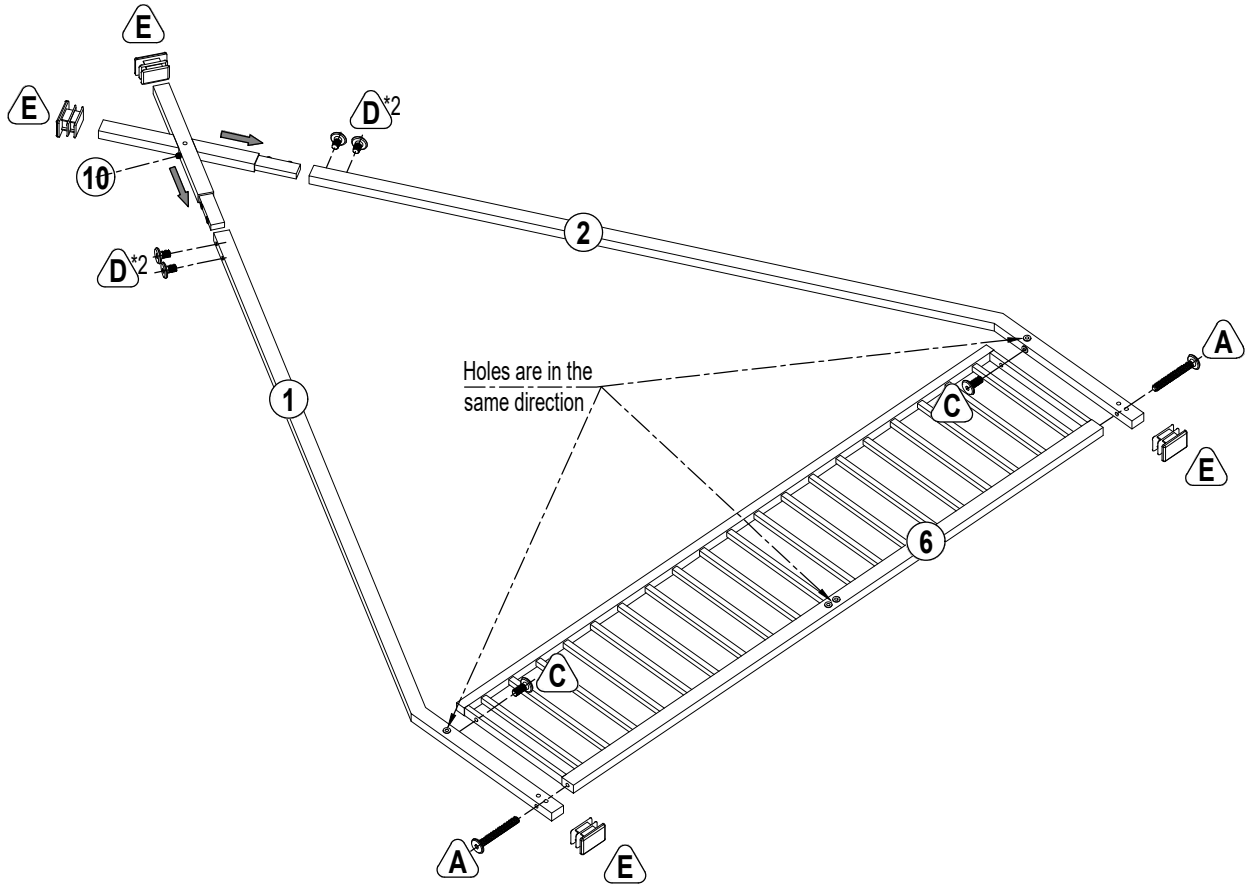

Wrench  
1 pcs

**STEP 1:**

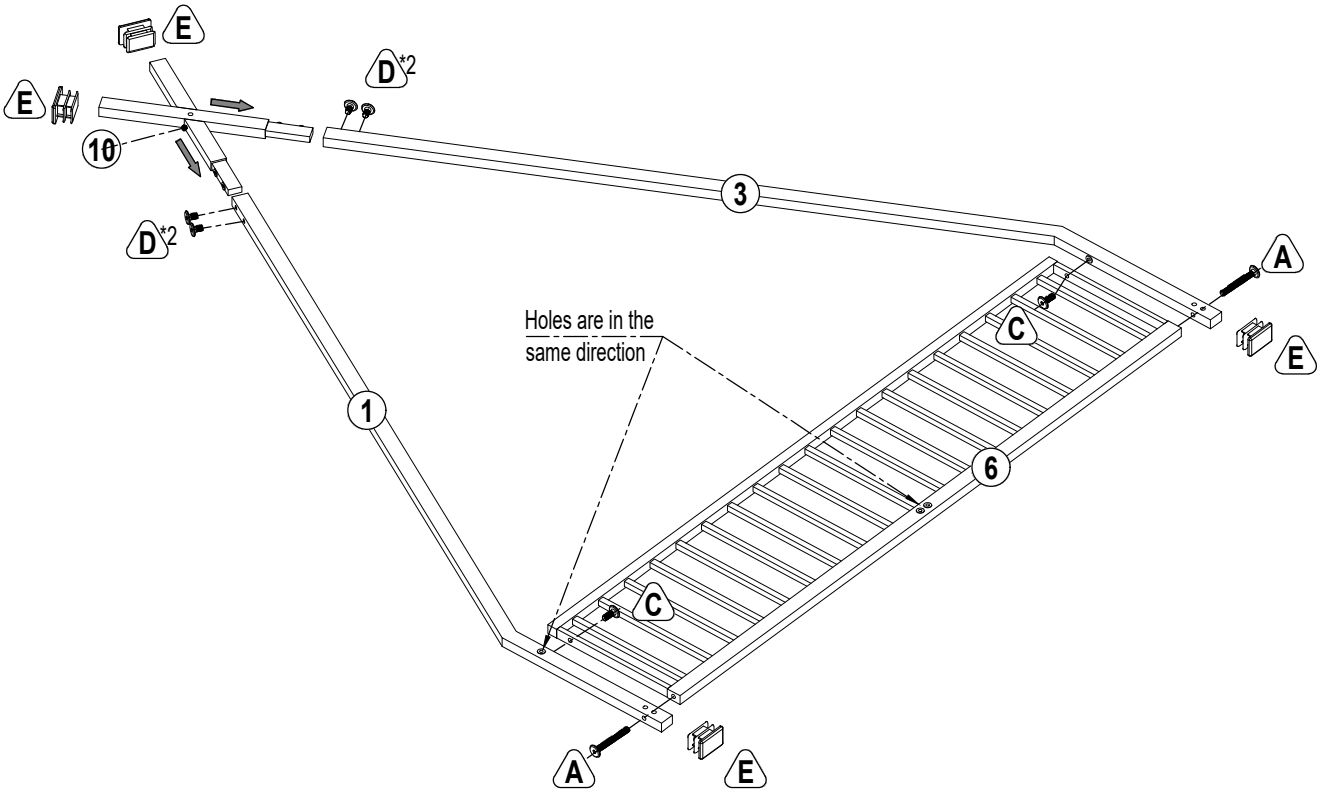

**STEP 2:**

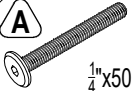
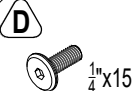
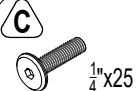

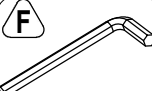
 <p><b>A</b> 1/4"x50 4 pcs</p>	 <p><b>D</b> 1/4"x15 8 pcs</p>	 <p><b>C</b> 1/4"x25 4 pcs</p>	 <p><b>E</b> 30x20 - 8 pcs</p>	 <p><b>F</b> 1 pcs</p>
--------------------------------------------------------------------------------------------------------------------------	---------------------------------------------------------------------------------------------------------------------------	---------------------------------------------------------------------------------------------------------------------------	-----------------------------------------------------------------------------------------------------------------------	---------------------------------------------------------------------------------------------------------------

**STEP 3:**

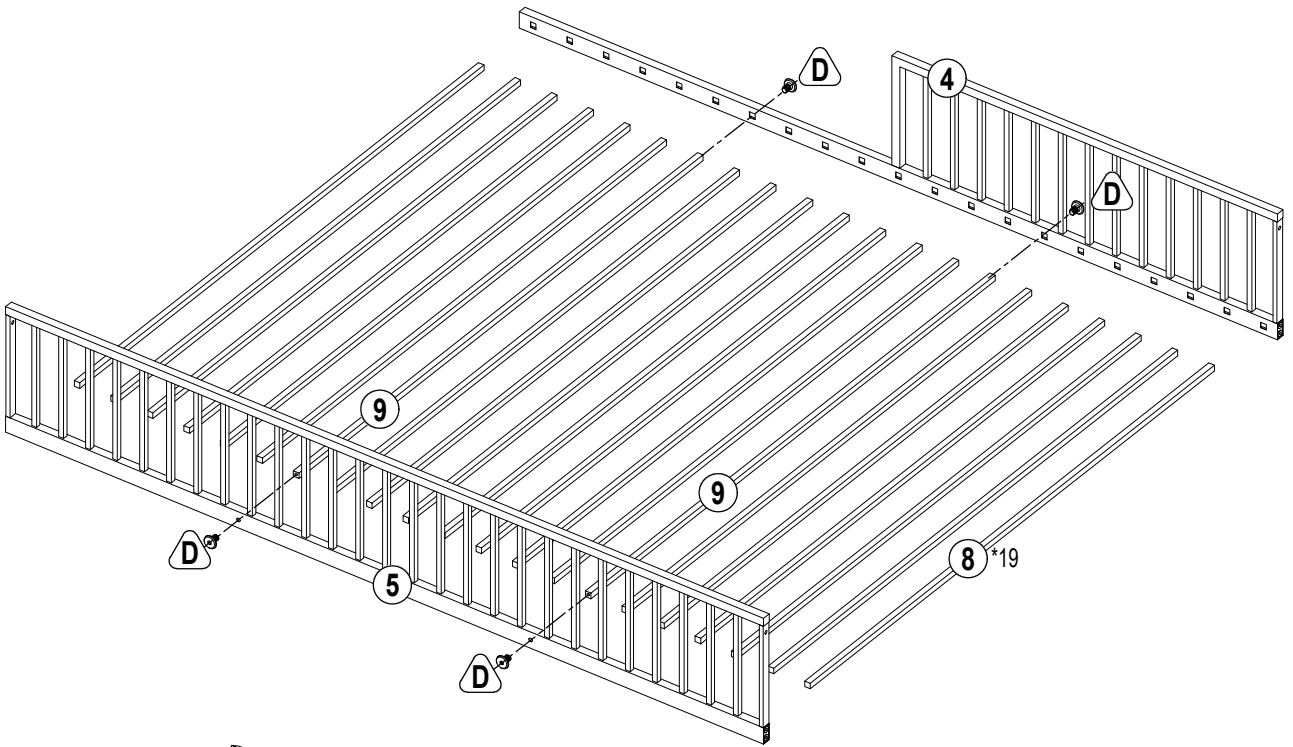

**STEP 4:**

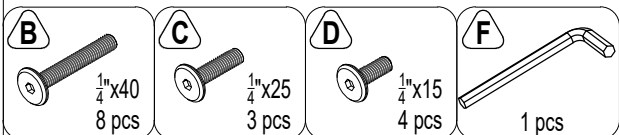
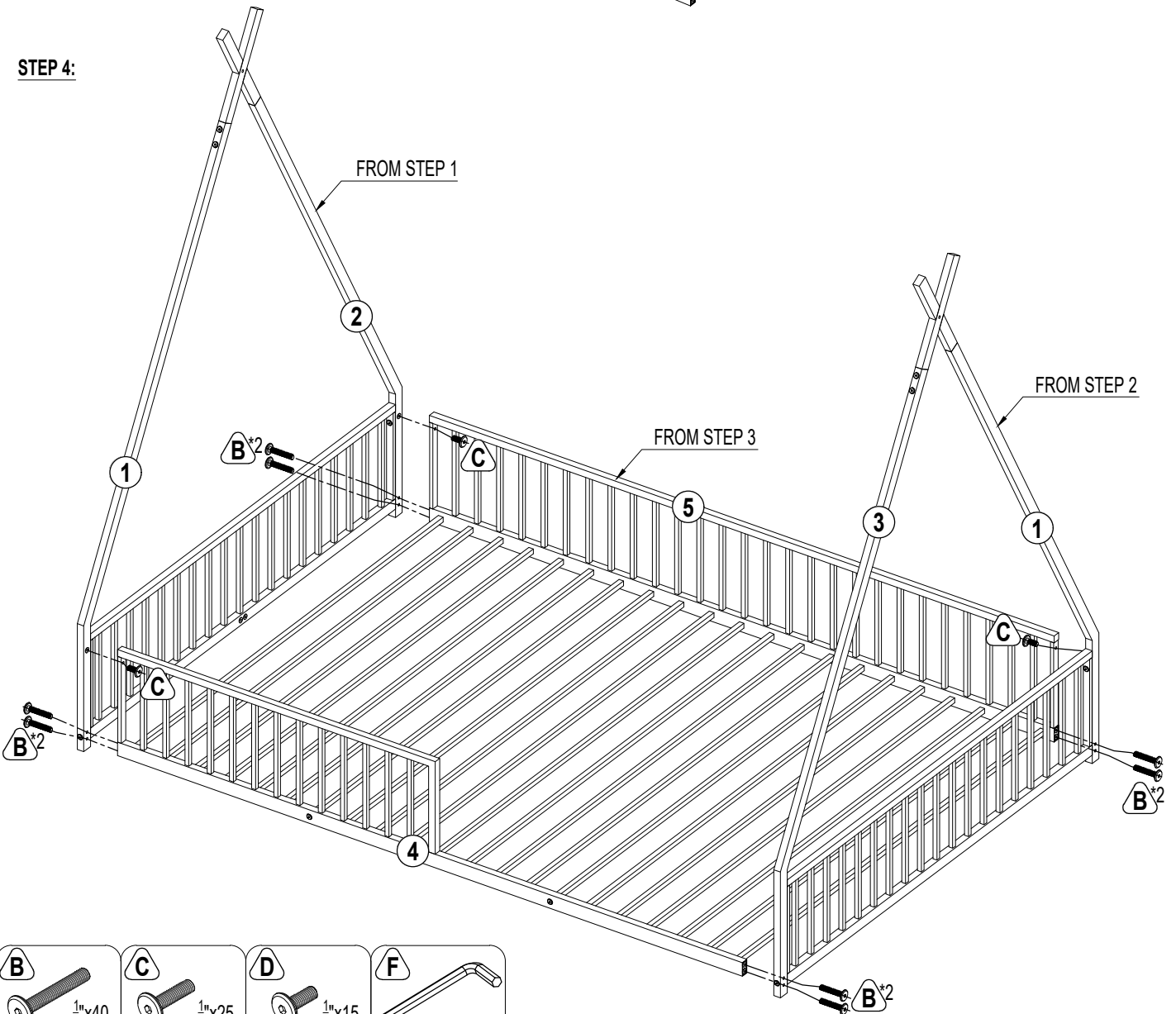

**STEP 5:**

