

# ASSEMBLY INSTRUCTIONS

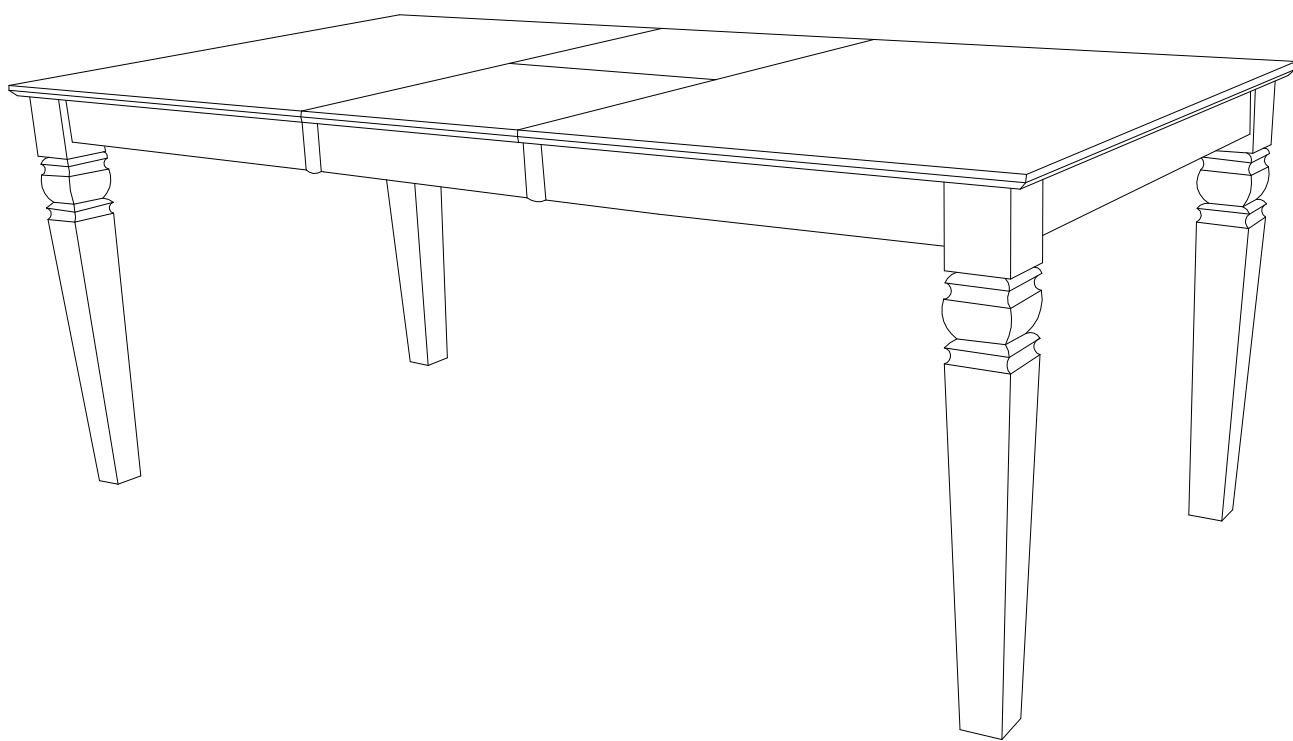

Description : RECTANGULAR DINING TABLE 60x42 WITH 18 IN BUTTERFLY LEAF

Dimension : W.42"x D.42"(60")x H.30"

Cube Size : 44.4"x44.4"x6.1"

(Top)

NW: 63.8 LBS

GW: 70.4 LBS

Cube Size : 30.8"x14.9"x4.3"

(Leg)

NW: 19.8 LBS

GW: 22 LBS

RECTANGULAR DINING TABLE 60x42 WITH 18 IN BUTTERFLY LEAF

## BEFORE ASSEMBLY

Thank you for purchasing this quality product. This product has been designed for easy assembly and constructed for durability. Please take the time to read and follow the assembly instructions carefully.

Be sure to check all packing material carefully for small parts which may have come loose inside the carton during shipment. Please separate, identify, and count all parts and metal hardware. Compare with part list to be sure all parts are present.

If hardware is missing or you have difficulty assembling this product, please call for us.

### IMPORTANT NOTE:

- Place all wooden parts on a clean and smooth surface such as a rug or carpet to avoid the parts from being scratched.
- Remove all wrapping material, including staples & packing straps before you start to assemble.
- DO NOT tighten all screws and bolts until completely assembled.
- Keep all hardware parts out of reach of children.

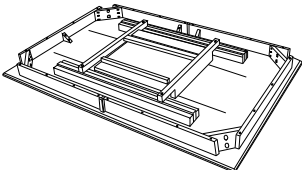
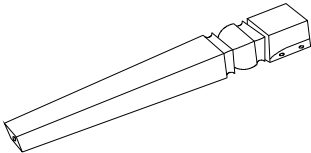

## PART LIST

When unpacking, please be careful not to discard any parts with the packaging. Before continuing, please make sure you have the following parts:

| NO | Description | Qty | Sketch   | NO | Description | Qty | Sketch   |
|----|-------------|-----|--|----|-------------|-----|--|
| A  | Top         | 1   |  | B  | Table Leg   | 4   |  |

## HARDWARE LIST

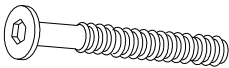
When unpacking, please be careful not to discard any parts with the packaging. Before continuing, please make sure you have all of the following hardware:

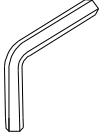
| NO | Description  | Qty | Sketch  | NO | Description  | Qty | Sketch  |
|----|--|-----|---|----|--|-----|---|
| 1  | Bolt<br>(M8x70)  | 8   |  | 2  | Lock washer<br>( $\Phi 8.5 \times \Phi 11 \text{mm}$ ) | 8   |  |
| 3  | Flat Washer<br>( $\Phi 8.5 \times \Phi 19 \text{mm}$ ) | 8   |  | 4  | Allen key<br>(M4mm)                                    | 1   |  |

RECTANGULAR DINING TABLE 60x42 WITH 18 IN BUTTERFLY LEAF

## STEP 1

Attach legs (B) to the top (A) with Bolts (1) and washers (2), (3). Tighten with the Allen Key (4).

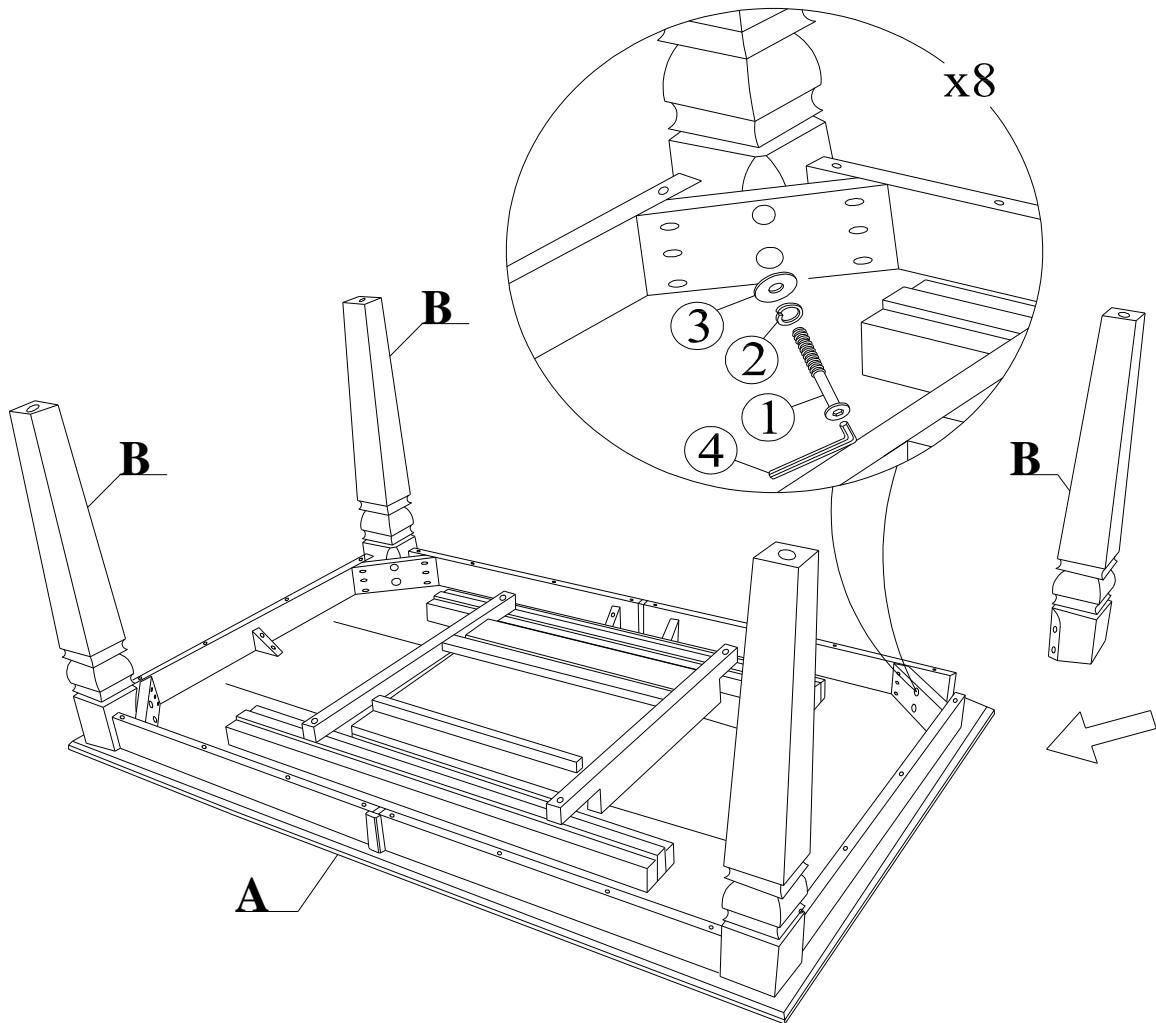

## STEP 2

Unlatch 2 end pieces of table top by the latches underneath table top. Pull the 2 ends of the table top apart.

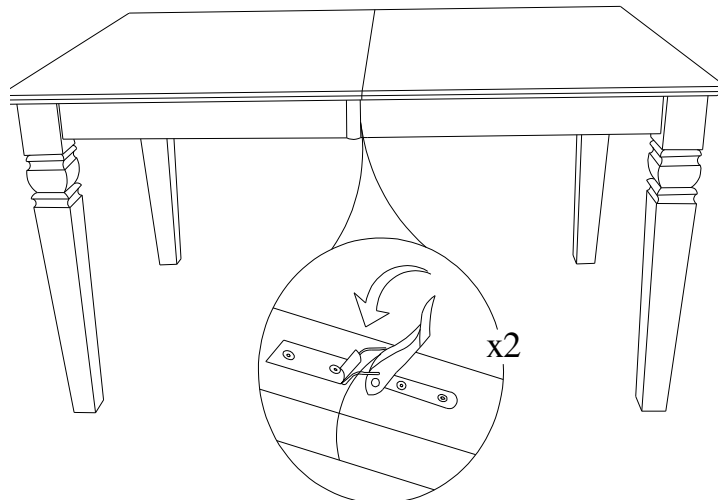

RECTANGULAR DINING TABLE 60x42 WITH 18 IN BUTTERFLY LEAF

### STEP 3

Unfold the butterfly leaf with the apron at both ends straightened up as shown on the Step 3. Place flattened butterfly leaf at the center of the table. Then push two end pieces inward making sure all pins & holes aligned. Latch them together by the 4 latches underneath table top.

