

ASSEMBLY INSTRUCTIONS

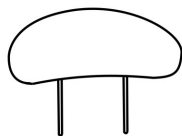

Ax1

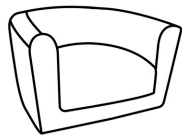

Bx1



Cx4



Dx12



Ex1

1

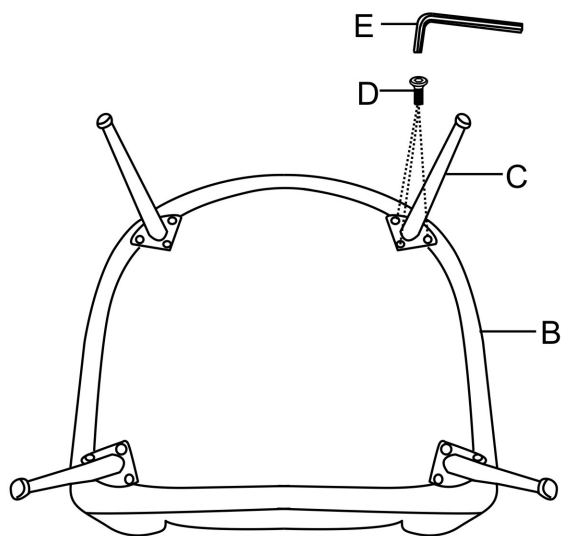

2

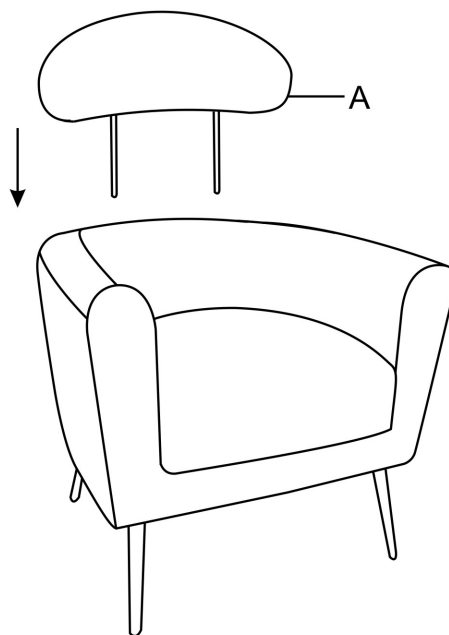

3

