

EROMMY!

Closer to Life!

—
WQSP255TN

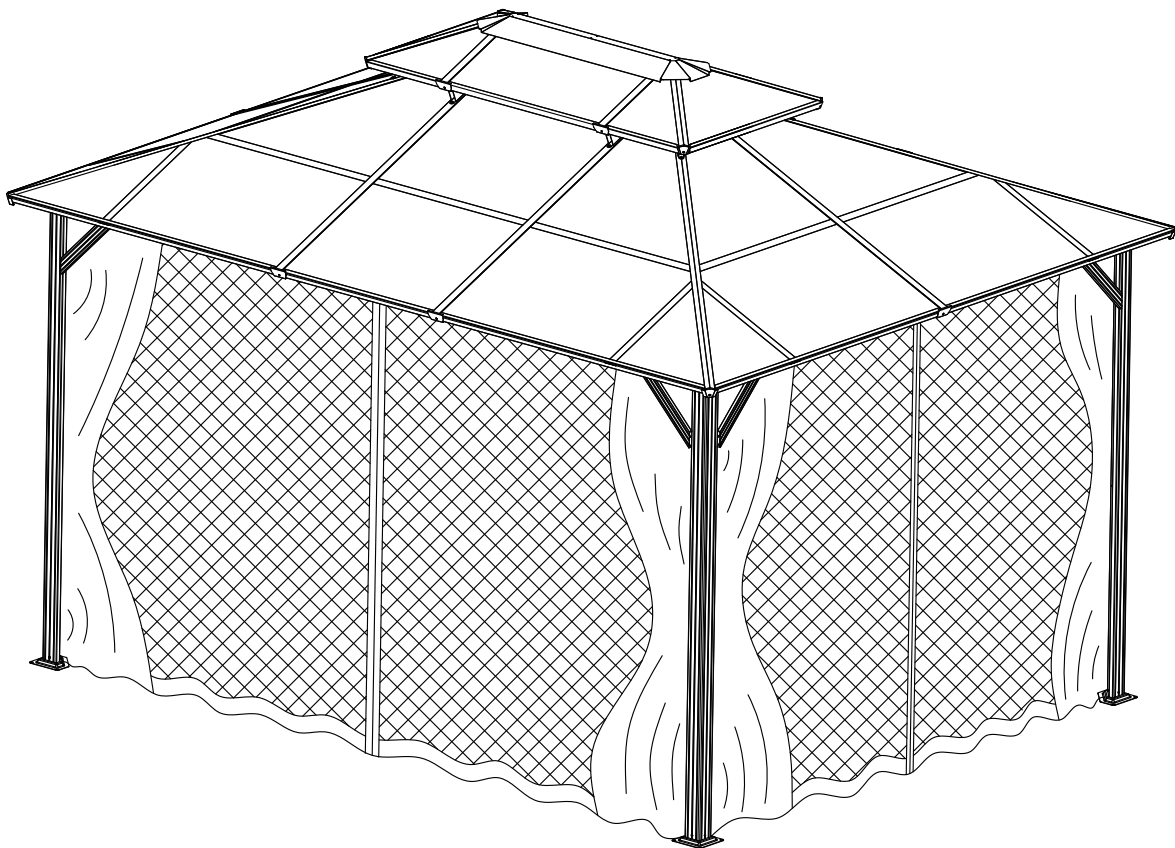

10x12.8ft

PC ROOF GAZEBO

Installation instructions

EROMMY PRODUCT INSTRUCTION

i Remember that the assembly might take (5) hours and requires (4) people.

REMEMBER

EROMMY isn't responsible for replacing parts lost or damaged during assembly. If you have issues, Email: service@erommy.com or Tel: **8886766299** instead of returning the unit.

IMPORTANT

Finalize site preparation and foundation construction before unpacking. Remove all parts from the packaging and check the right count and type of pieces before assembling.

! CAUTION

- Consult local authorities to ensure you have the required permits and are aware of any applicable local building regulations.
- It's crucial to review the site preparation information in the manual beforehand to get everything ready.
- Read instructions thoroughly before starting assembly. Follow the steps carefully because the kit contains parts that might be damaged if constructed incorrectly.
- Please handle the kit with caution since some parts have sharp metal edges.
- Avoid working in severe winds or extreme cold and wear gloves, eye protection, and long sleeves during assembly or maintenance.
- When filling it, store heavier items near the bottom. The product isn't intended for children to play in, and don't stand, sit, or store anything on the roof.

BRAND STORY

Guided by the ideology of “Closer to Life” , EROMMY is committed to bringing you refined and trustworthy products that fit your needs. Our vision is to empower every customer to stay close to nature and ultimately transform their lifestyle.

EROMMY, Closer to Life!



PACKING LIST

Serial number

Box A

Part name	H	H1	J	J1	J2	J3	K
Qty	1	1	4	4	4	4	4
Part name	K1	K2	K3	L	L1	L2	Q
Qty	4	4	2	2	2	2	1
Part name	Q1	Q2	R	S	T	T1	
Qty	8	2	4	4	4	1	

PACKING LIST















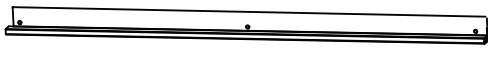

Serial number

Box B

Part name	A	B	B1	B2	B3	B4	B5
Qty	4	2	2	2	2	2	2
Part name	B6	B7	C	C1	D	D1	D2
Qty	2	2	4	4	4	4	4
Part name	D3	D4	E	E1	E2	E3	E4
Qty	2	4	4	4	4	4	2
Part name	F	F1	F2	G	G1	I	M
Qty	8	4	4	2	2	2	4
Part name	N	N1	O	O1	O2	O3	P
Qty	4	4	8	8	4	6	8
Part name	P1	P2	U	U1	V	W	W1
Qty	10	3	80	8	32	146	18
Part name	X	X1	Y	Y2	Z	Z1	Z2
Qty	8	16	12	3	12	1	1
Part name	Z3						
Qty	1						





ASSEMBLY

Instruction

	A x4
	B x2
	B1 x2
	B2 x2
	B3 x2
	B4 x2
	B5 x2
	B6 x2
	B7 x2
	C x4
	C1 x4
	D x4
	D1 x4
	D2 x4
 	D3 x2

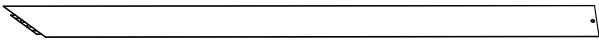
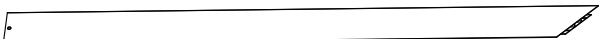
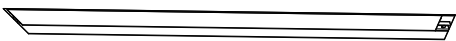
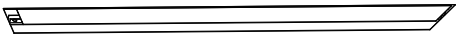
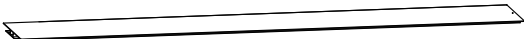
ASSEMBLY

Instruction

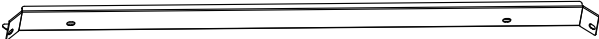
	D4 x4
	E x4
	E1 x4
	E2 x4
	E3 x4
	E4 x2
	F x8
	F1 x4
	F2 x4
	G x2
	G1 x2

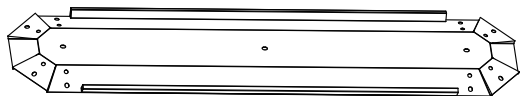
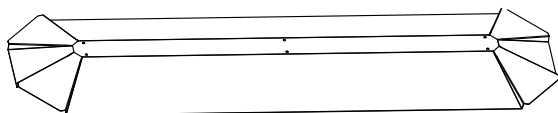
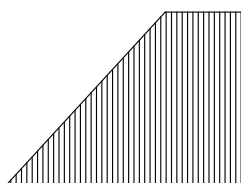
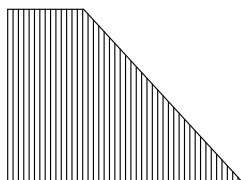
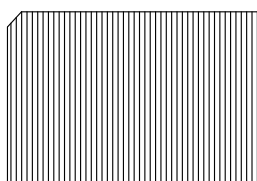
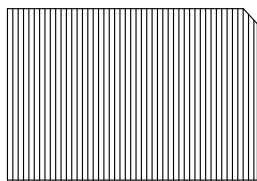
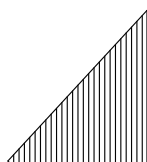
**H** x1**H1** x1**I** x2**J** x4**J1** x4**J2** x4**J3** x4**K** x4

ASSEMBLY

Instruction

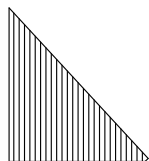

K1 x4

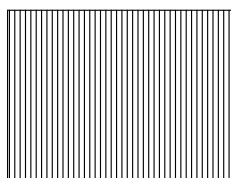

K2 x4

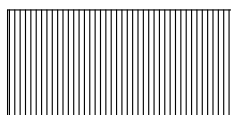

K3 x2

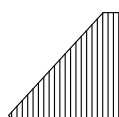

L x2

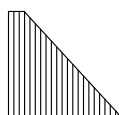

L1 x2

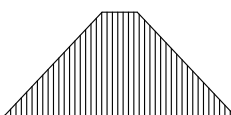

L2 x2





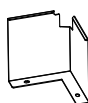







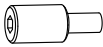

M x4

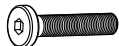



N x4

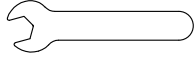

N1 x4

		T1 x1
		U x80
	Ø11 * Ø6* 20mm	U1 x8
		V x32
	M6 * 15 mm	W x146
	M6 * 20mm	W1 x18
	M6 * 35 mm	X x8
	M4 * 12 mm	X1 x16
	ST4.8* 12 mm	Y x12
	M6	Y2 x3
		Z x12
		Z1 x1
		Z2 x1
		Z3 x1

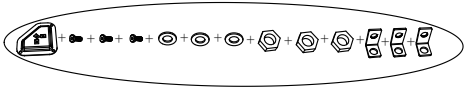
No.	Qty	Picture	No.	Qty	Picture
A	4		W	12	 M6 * 15 mm
R	4				

Step1

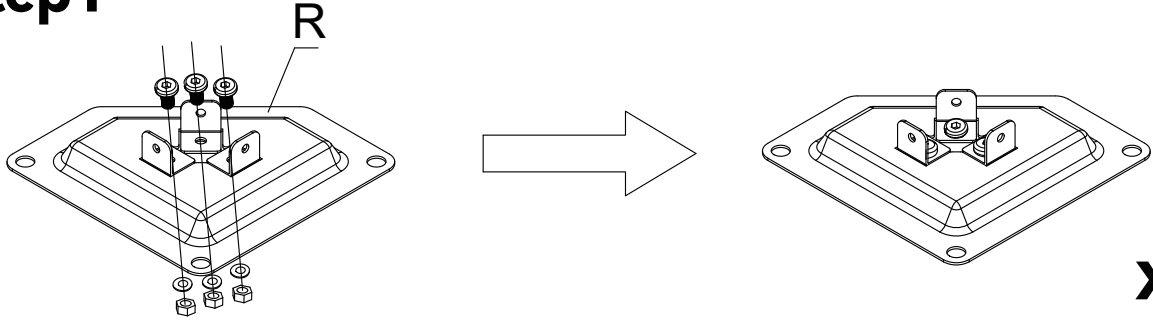

Step2

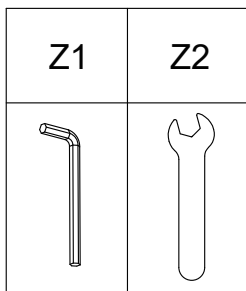
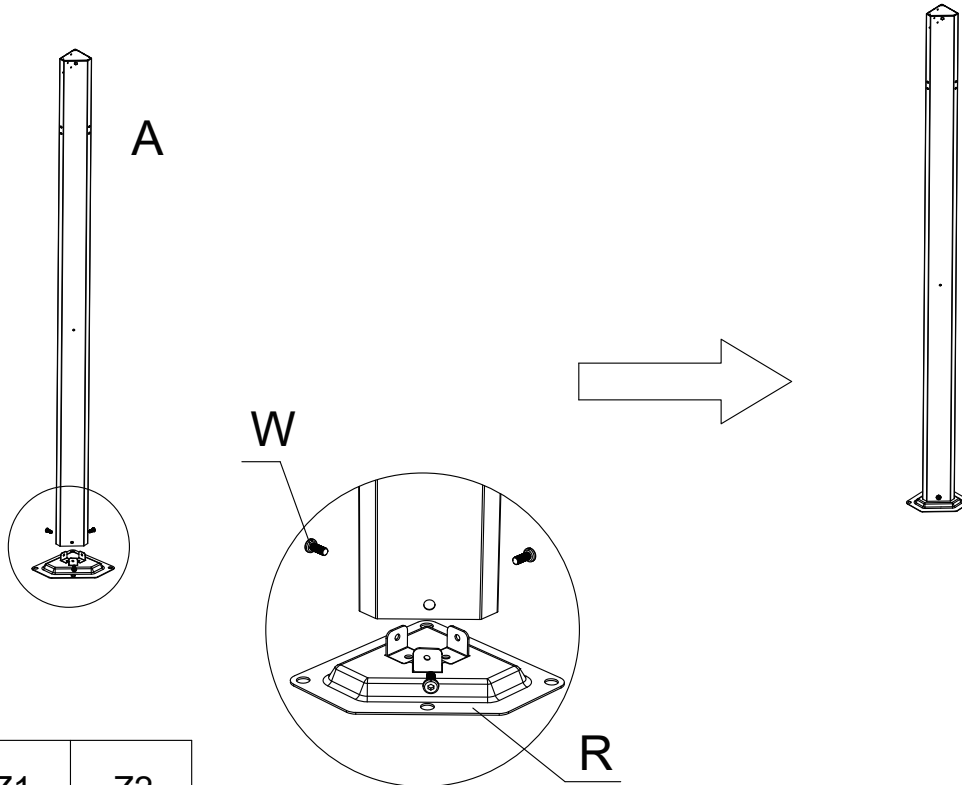

4pcs

No.	Qty	Picture	No.	Qty	Picture
B	2		B1	2	
B2	2		B3	2	
B4	2		B5	2	
B6	2		B7	2	
W	16	M6 * 15 mm			

Step3

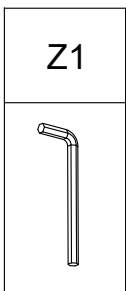
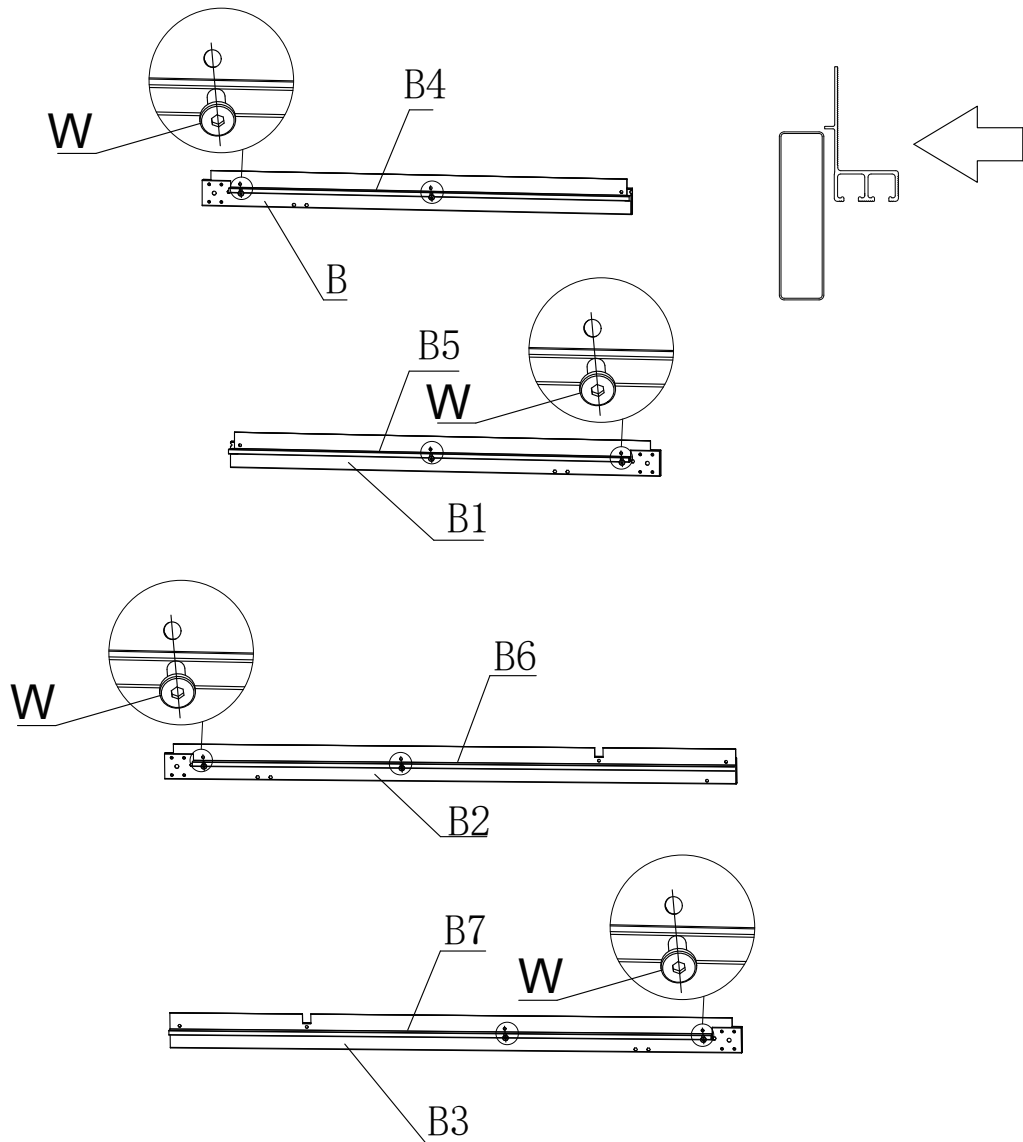

x2

No.	Qty	Picture	No.	Qty	Picture
B	2		B1	2	
B2	2		B3	2	
W	40	 M6 * 15 mm	M	4	

Step4

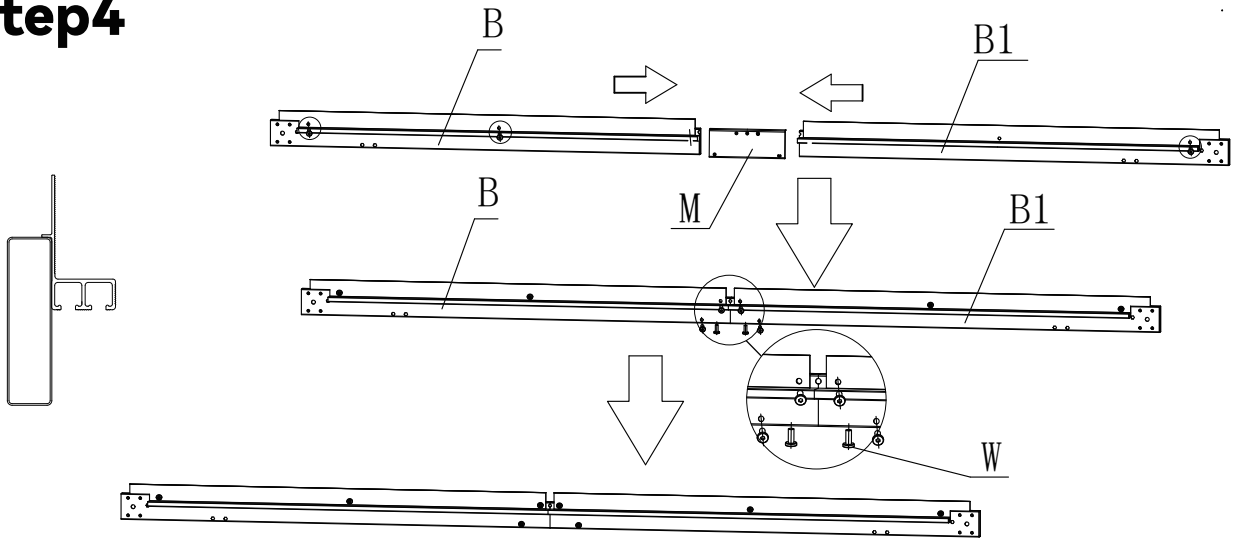

x2

Step5

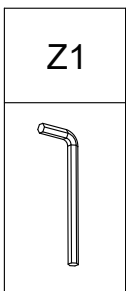
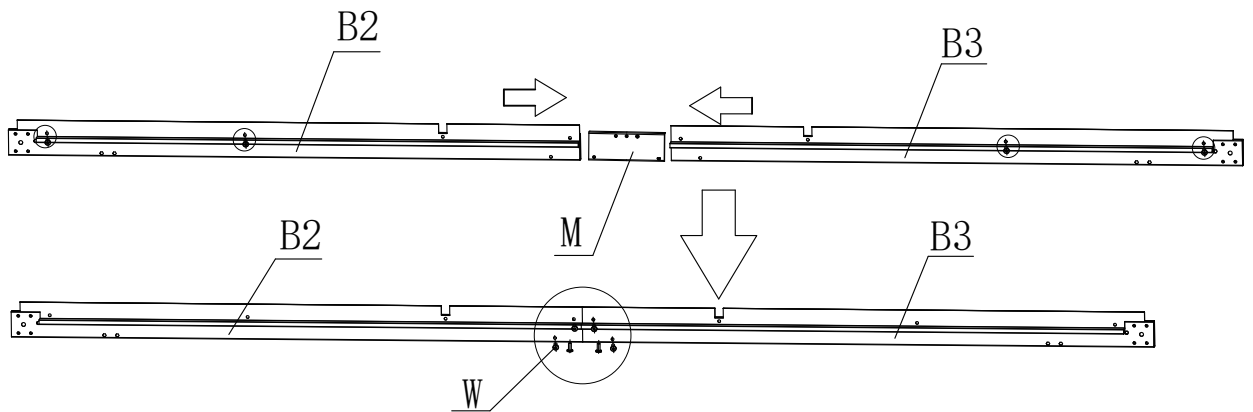



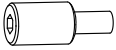

x2

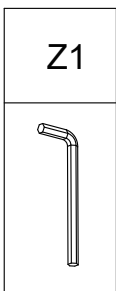
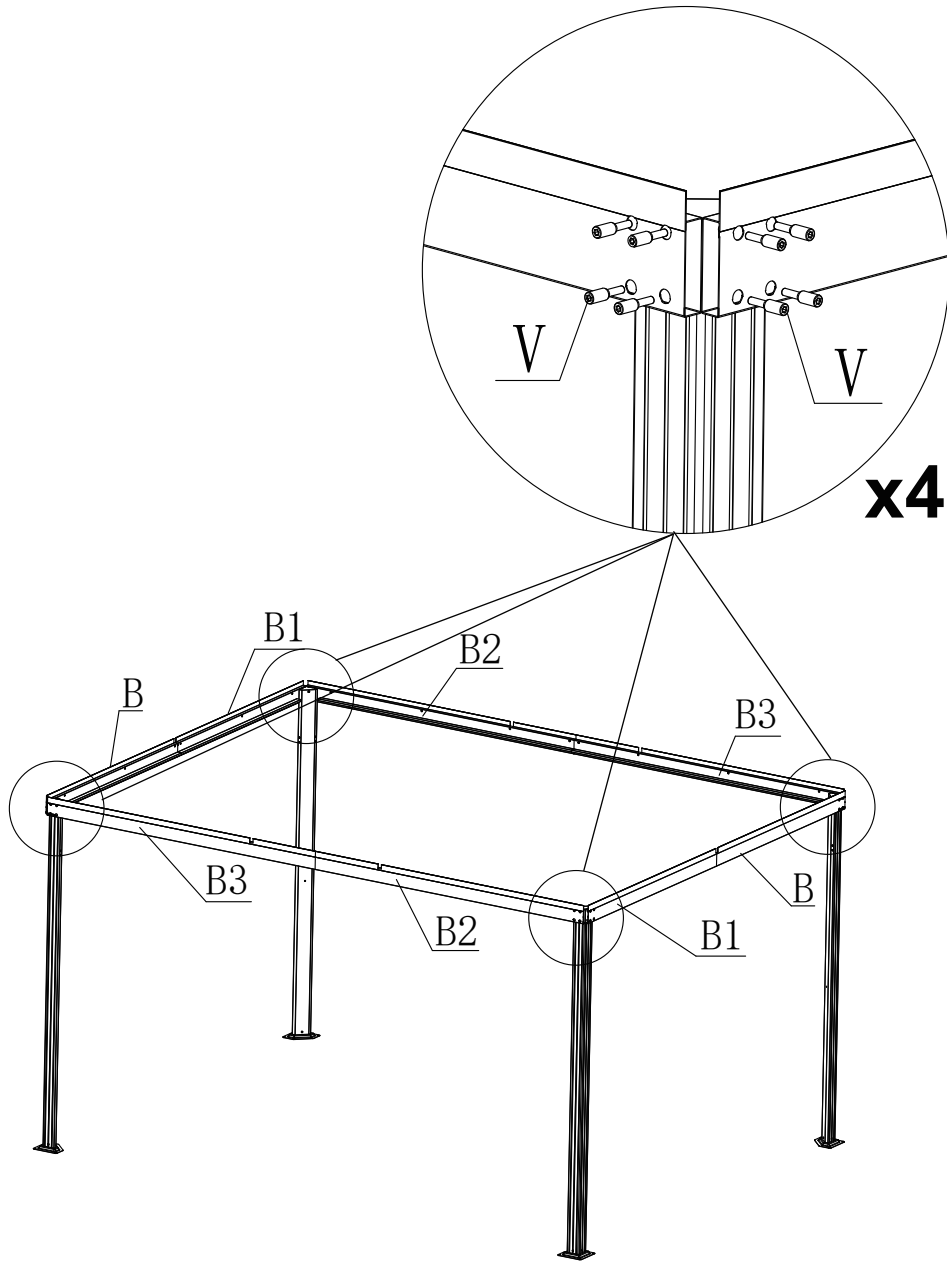
No.	Qty	Picture	No.	Qty	Picture
V	32				



Step 6



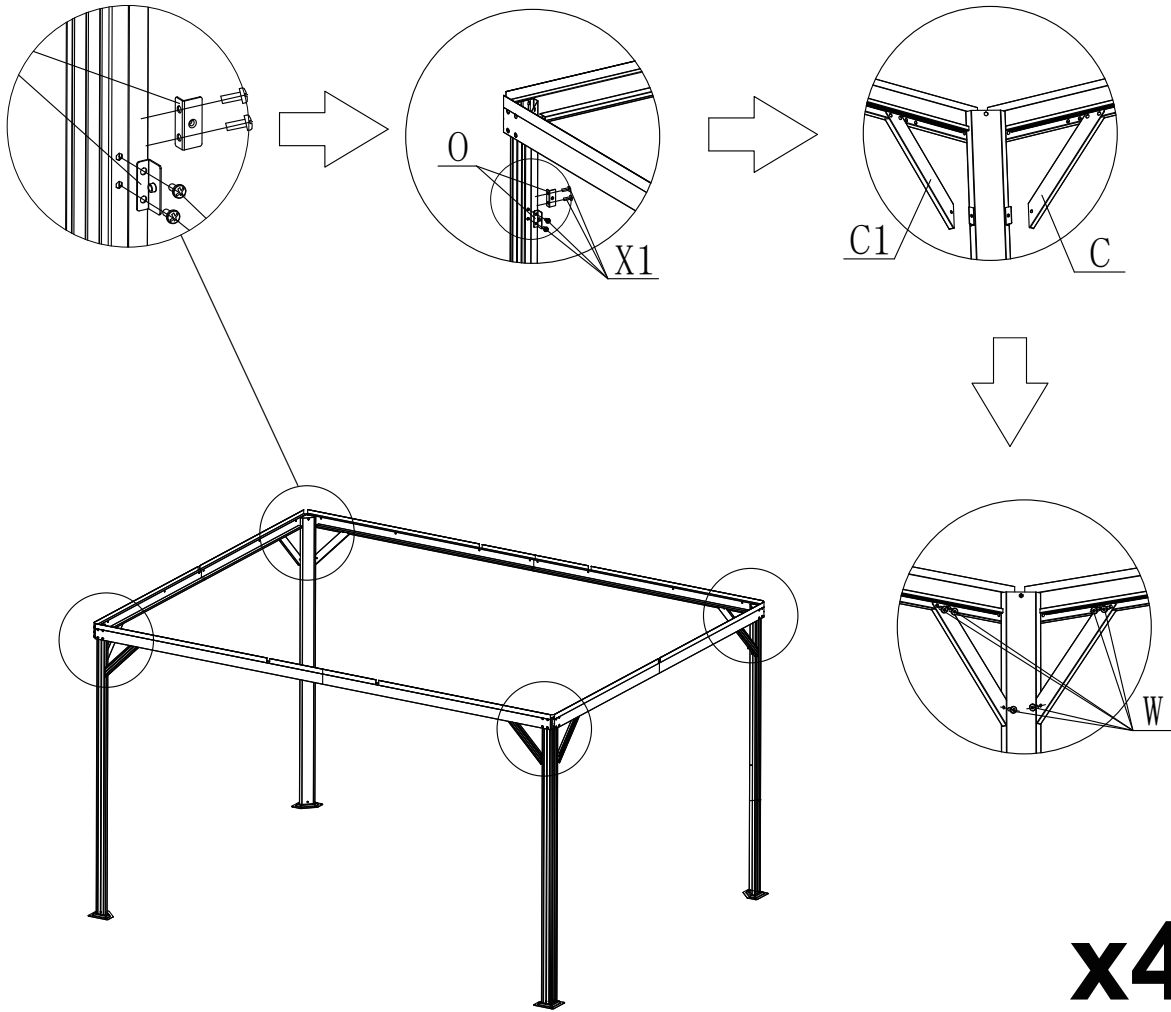

No.	Qty	Picture	No.	Qty	Picture
C	4		W	24	 M6 * 15 mm
C1	4		O	8	
			X1	16	 M4 * 12 mm

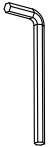
Step 7





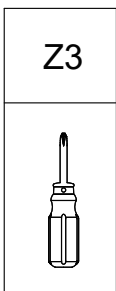
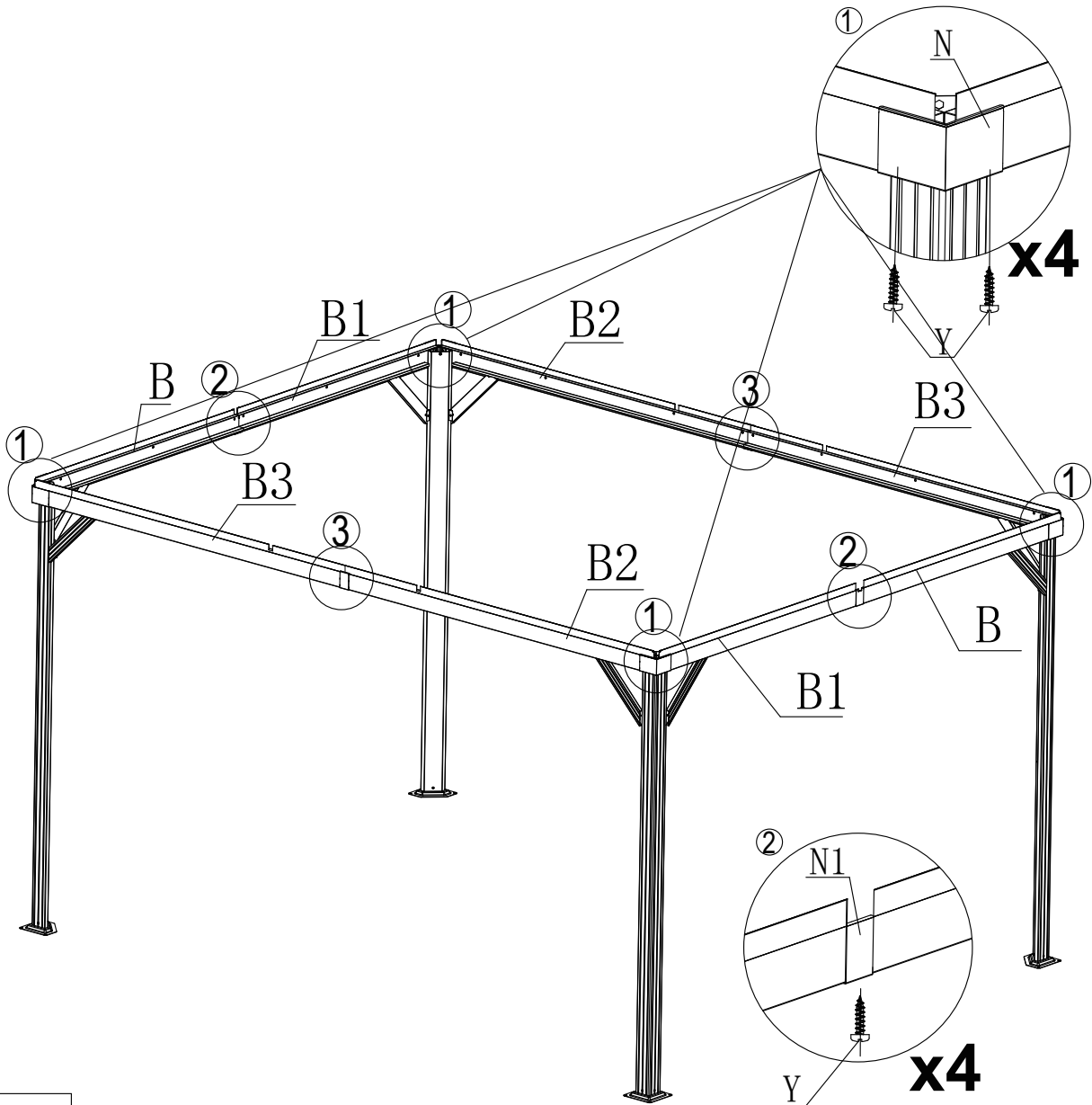

Z1	Z3
	

No.	Qty	Picture	No.	Qty	Picture
N	4		Y	12	 ST4.8* 12 mm
N1	4				

Step8



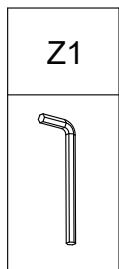
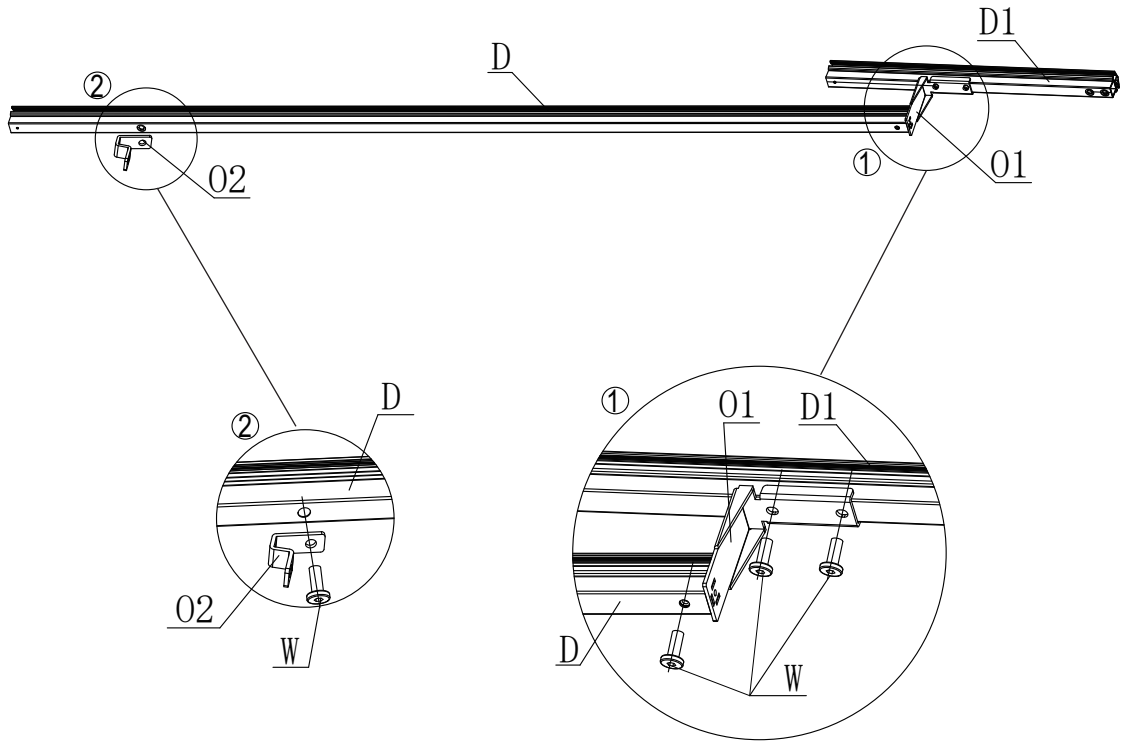

No.	Qty	Picture	No.	Qty	Picture
D	4		W	16	
D1	4		O1	4	
O2	4				

Step9

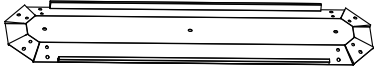

x4

No.	Qty	Picture	No.	Qty	Picture
H	1		W	12	 M6 * 15 mm

Step10

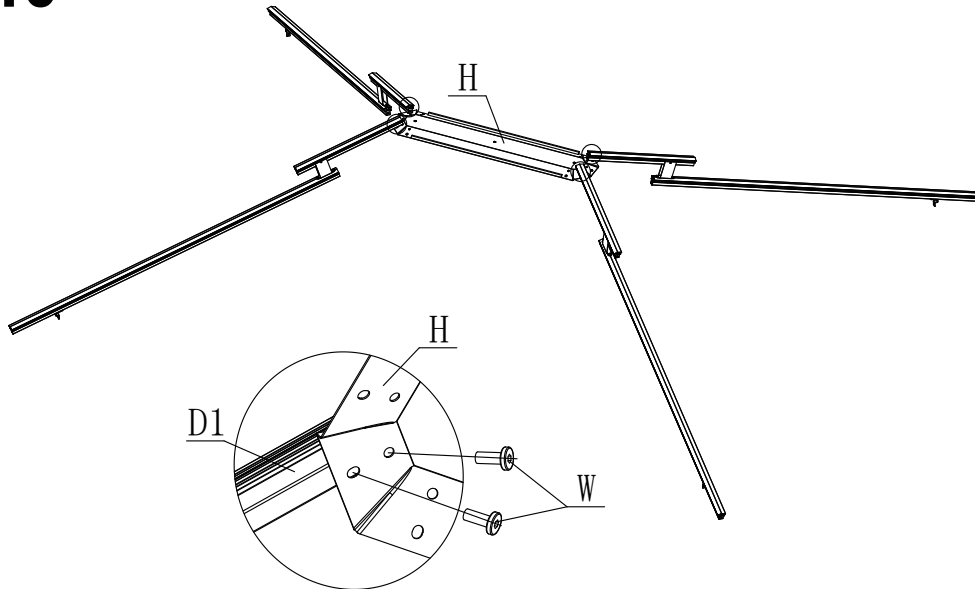



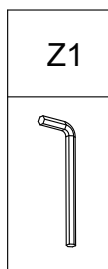
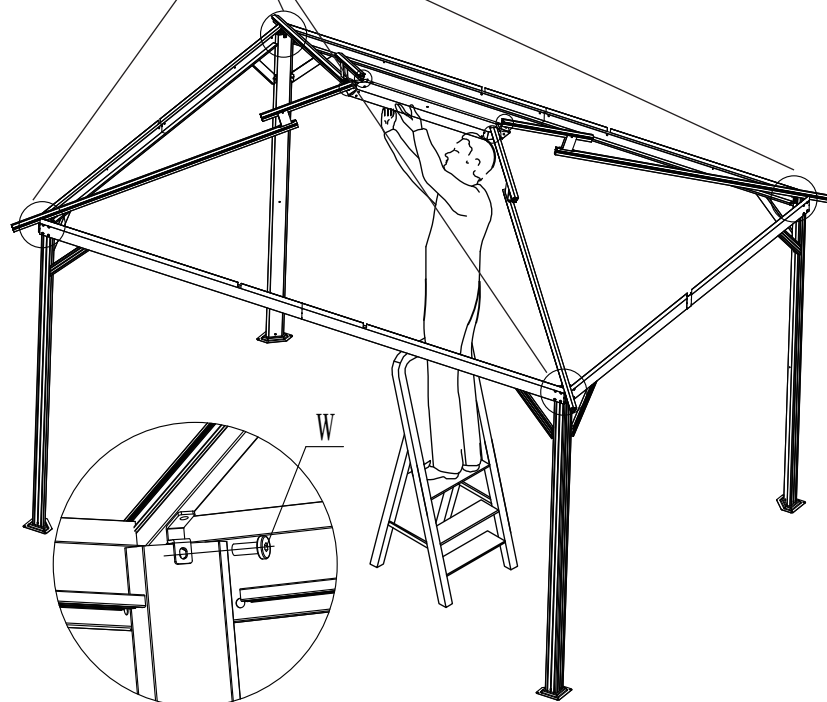

Step11



Note:

1. Have one person stand on the ladder to lift and hold "H" while others fasten the screws of "V"
2. Do not release "H" until all the "V" screws are fully tightened.

No.	Qty	Picture	No.	Qty	Picture
D2	4		W	16	 M6 * 15 mm
D4	4		O1	4	
O3	4				

Step12

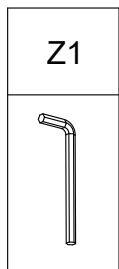

No.

Qty

Picture



W

12

M 15 mm

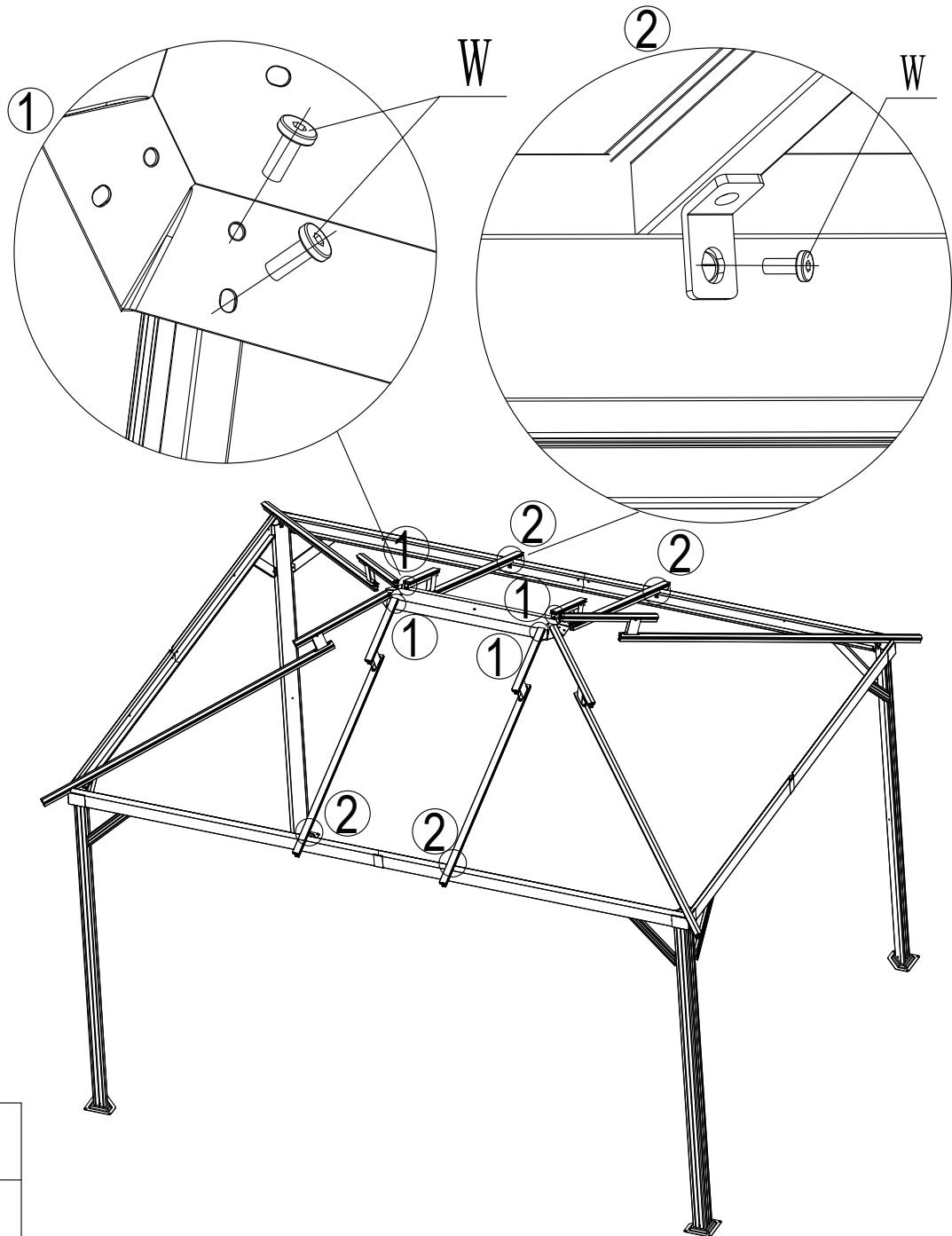



Step 13

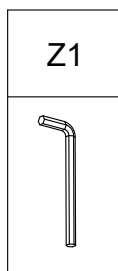
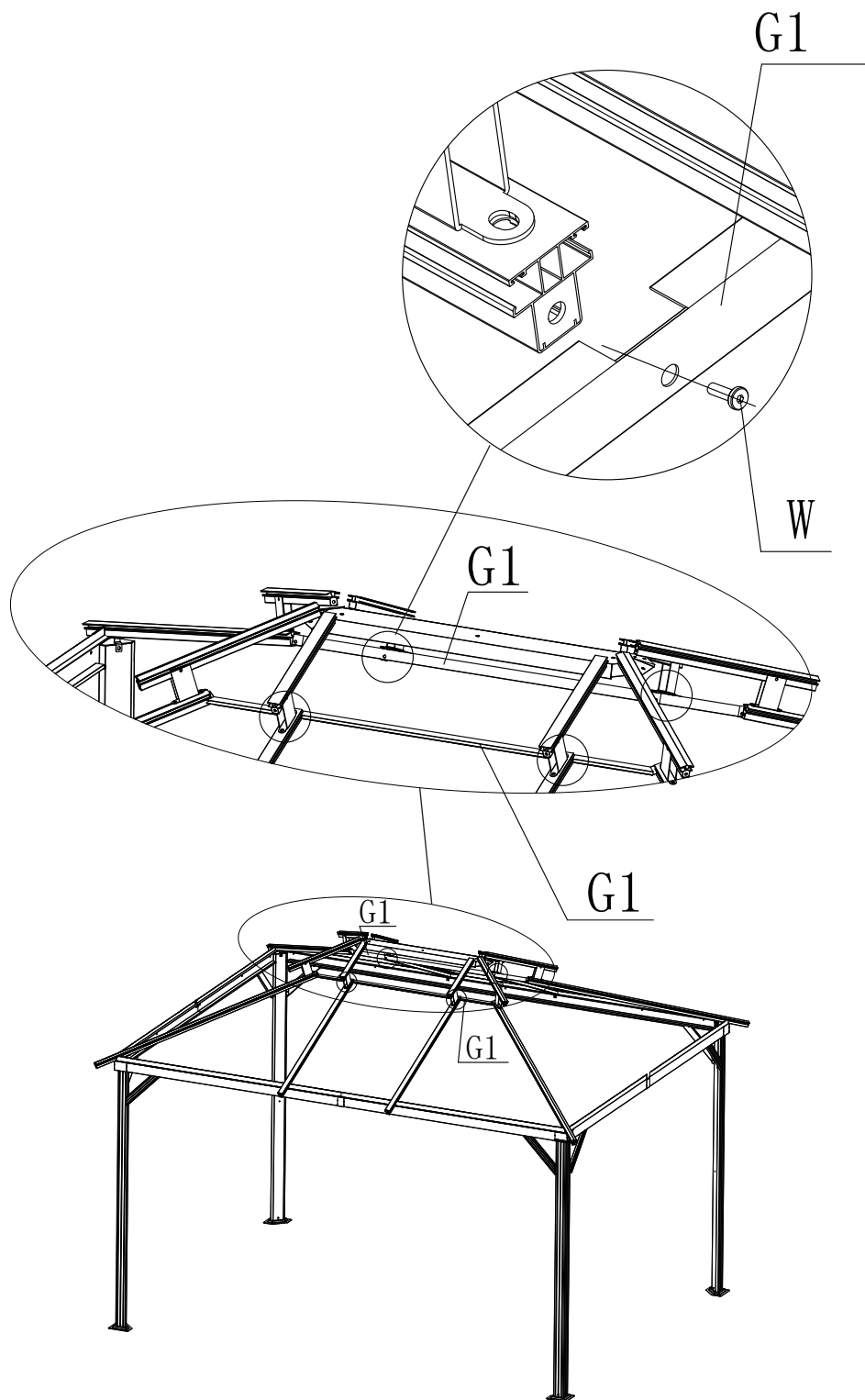

No.	Qty	Picture	No.	Qty	Picture
G1	2		W	4	 M6 * 15 mm

Step14



No.	Qty	Picture	No.	Qty	Picture
D3	2		W	4	 M6 * 15 mm
I	2		O3	2	

Step15

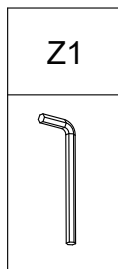
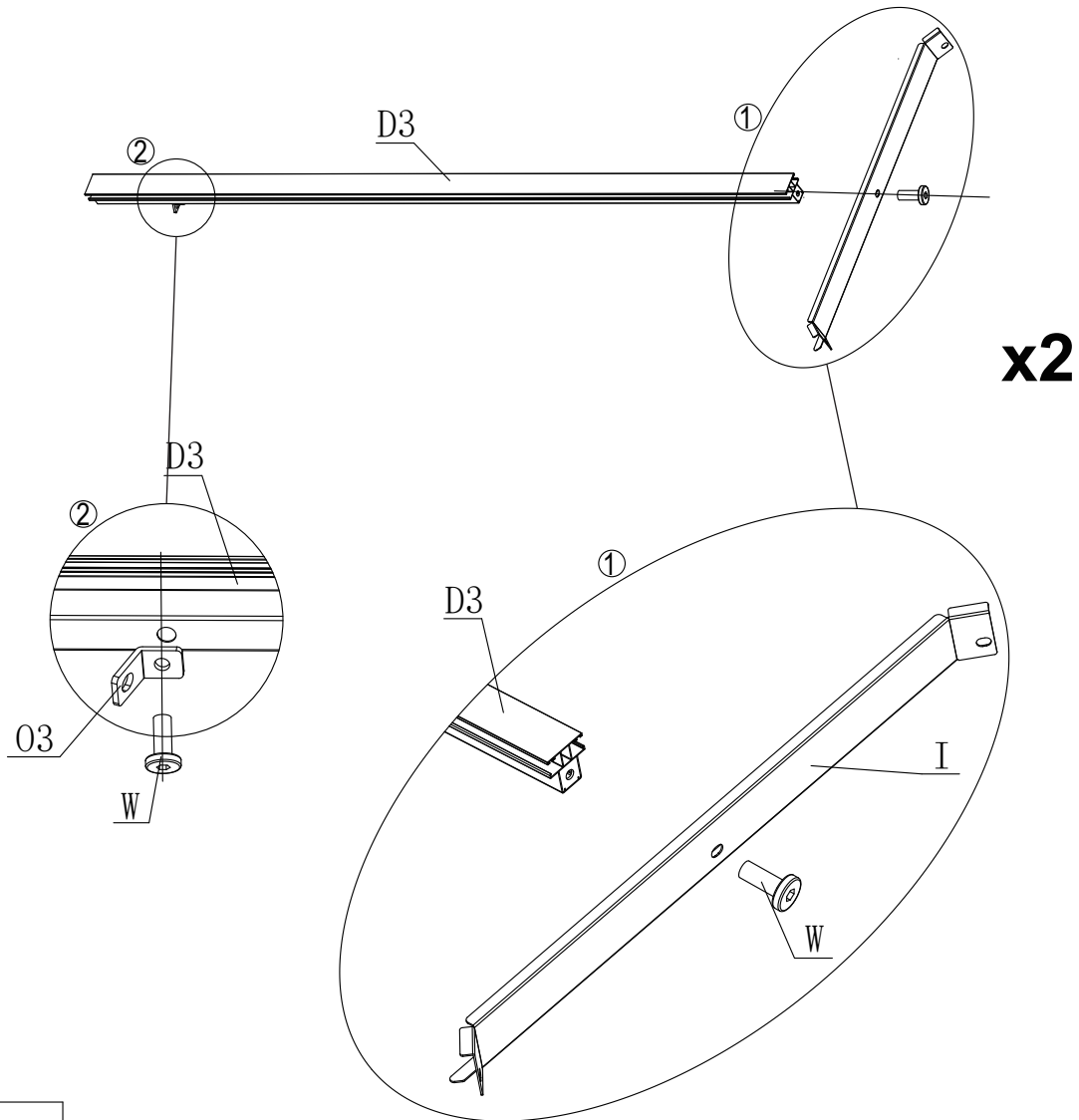

No.

Qty

Picture

W

6

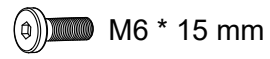



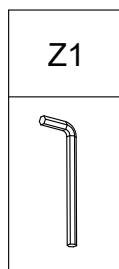
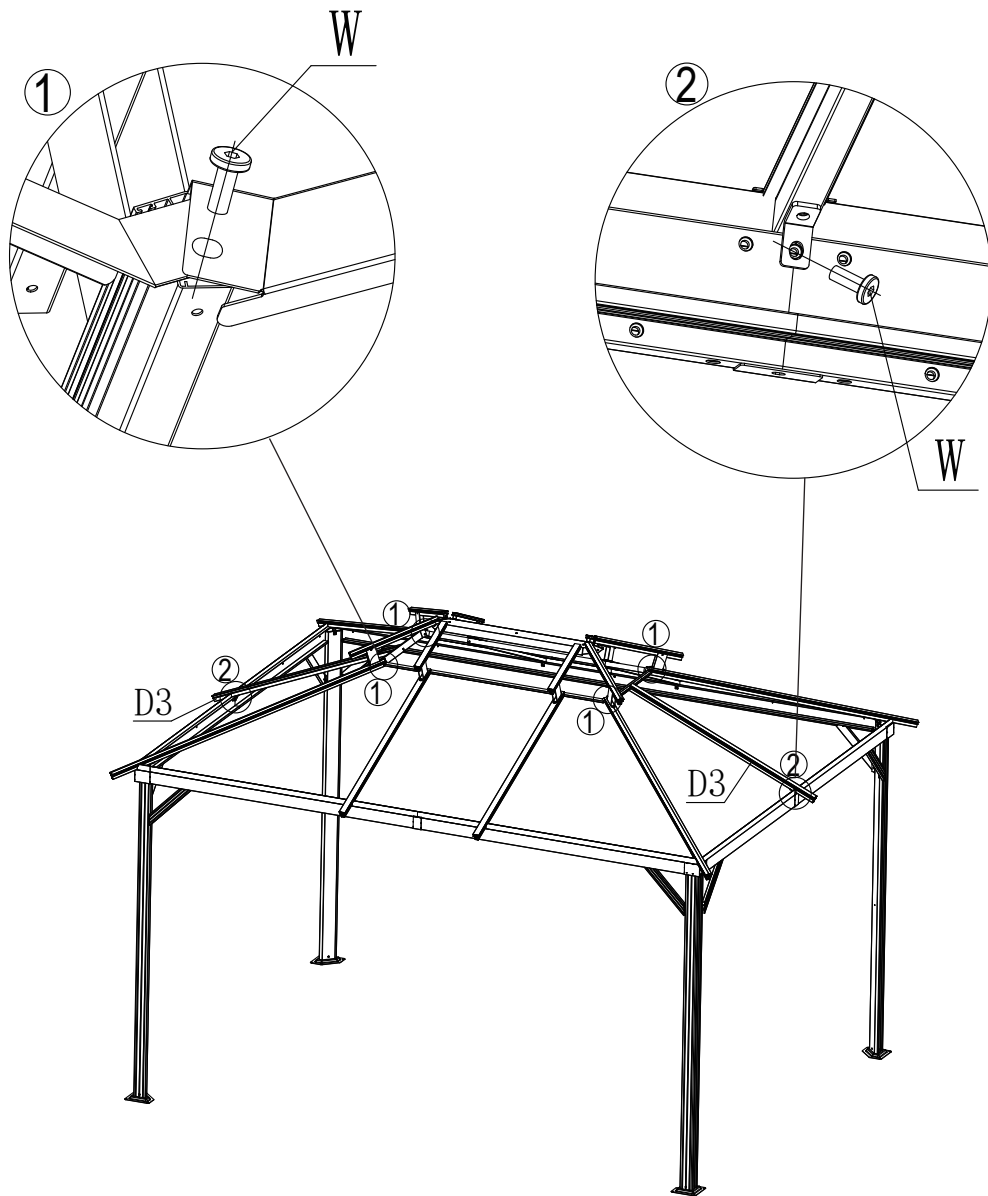

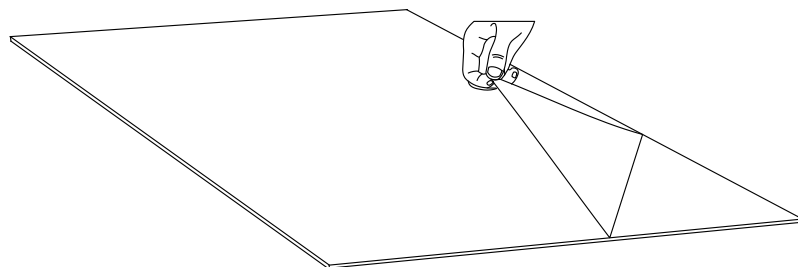
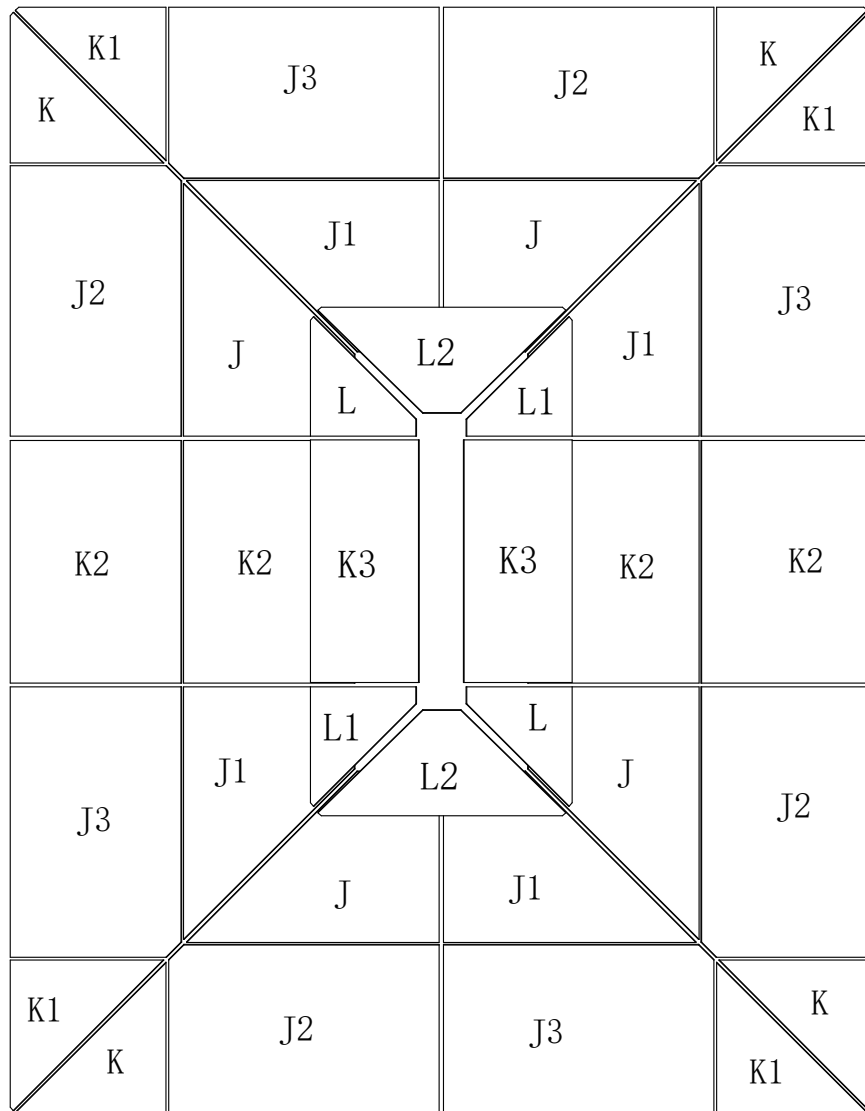

Step16

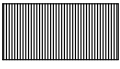

Step 17





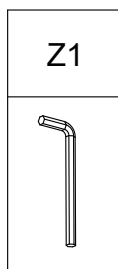
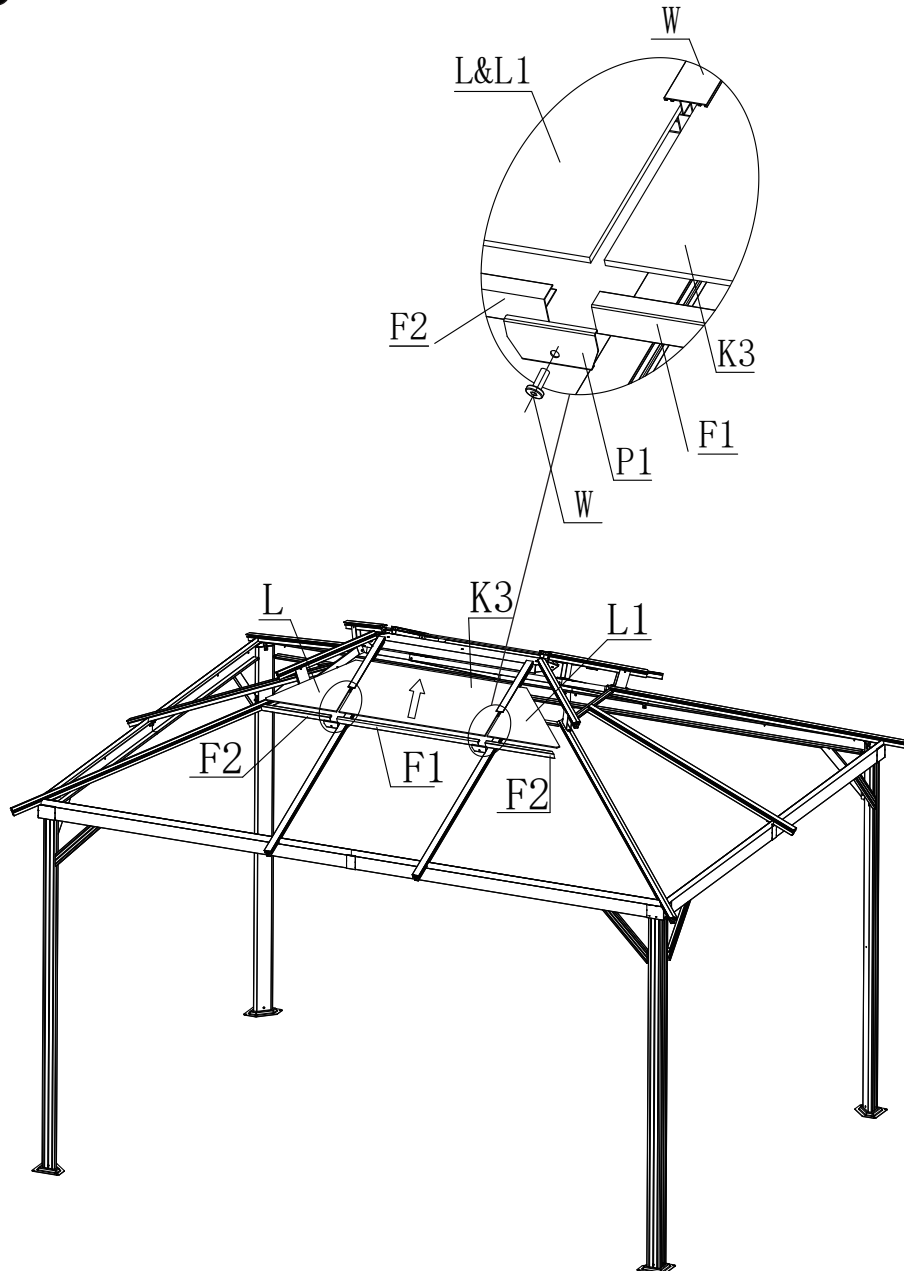

Remove the protective film
before installation.

No.	Qty	Picture	No.	Qty	Picture
K3	2		L	2	
L1	2		F2	4	
F1	2				
P1	4		W	4	 M6 * 15 mm

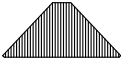
Step18





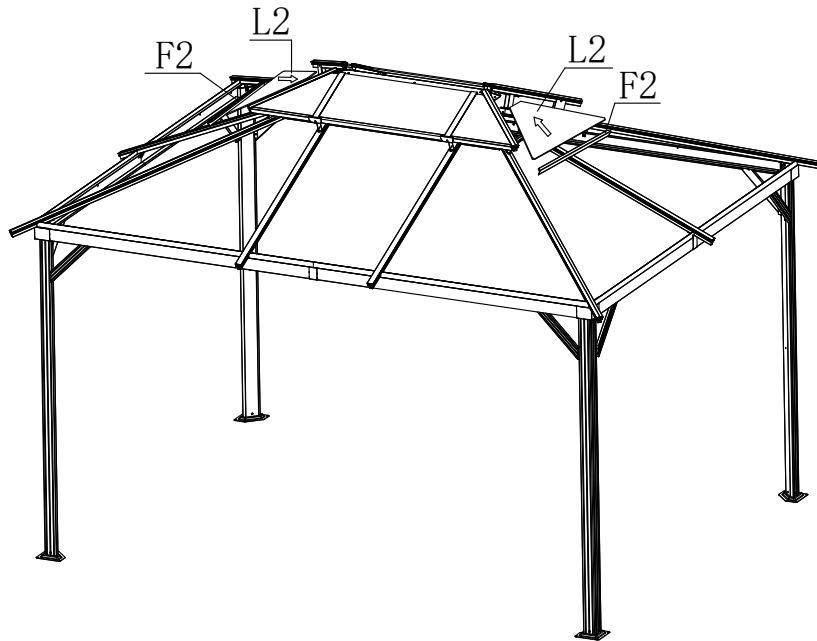

No.	Qty	Picture	No.	Qty	Picture
L2	2		P	4	
G	2		W	4	 M6 * 15 mm

Step19

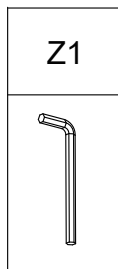
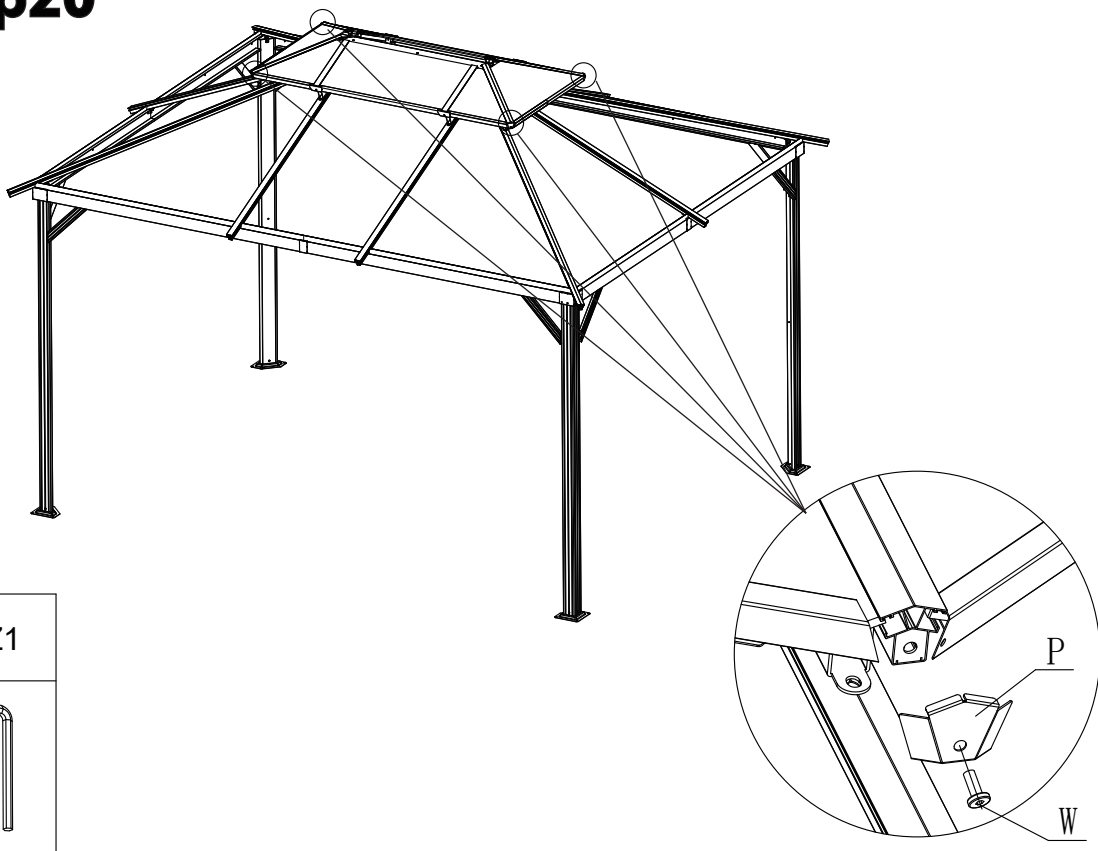

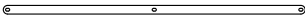

Step20

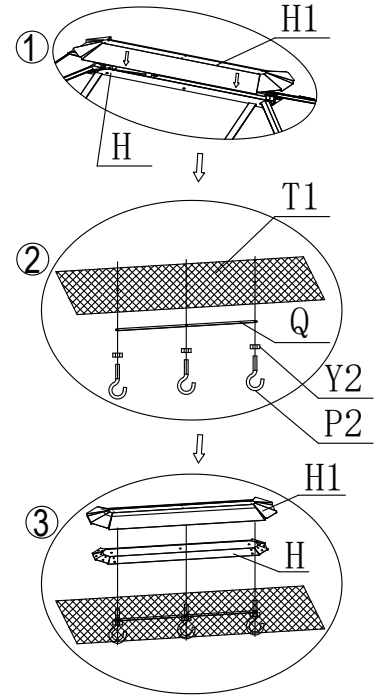
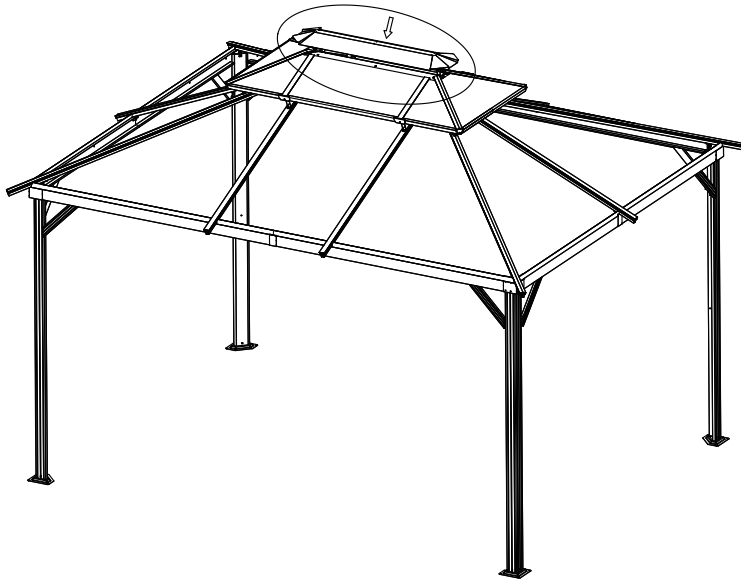

No.	Qty	Picture	No.	Qty	Picture
H1	1		T1	1	
Q	1		P2	3	
Y2	3	 M6			

Step21



No.	Qty	Picture	No.	Qty	Picture
Q1	8		Q2	2	

Step22

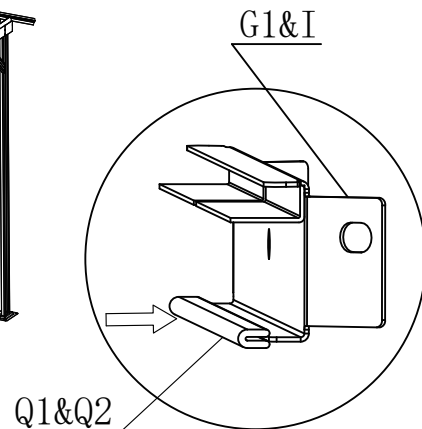
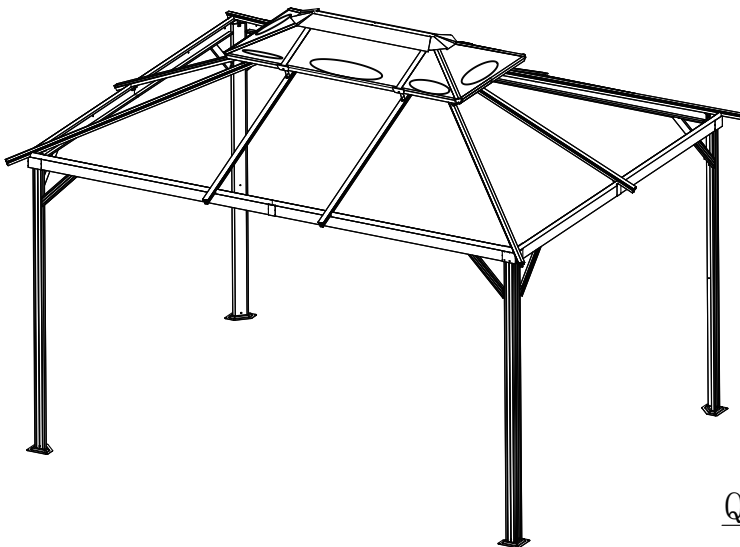

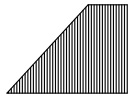
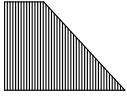
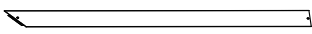
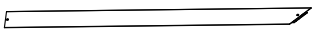
No.	Qty	Picture	No.	Qty	Picture
J	4		J1	4	
E	4		E1	4	

Step23

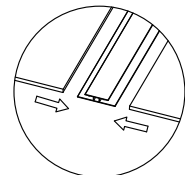
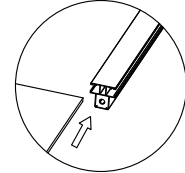
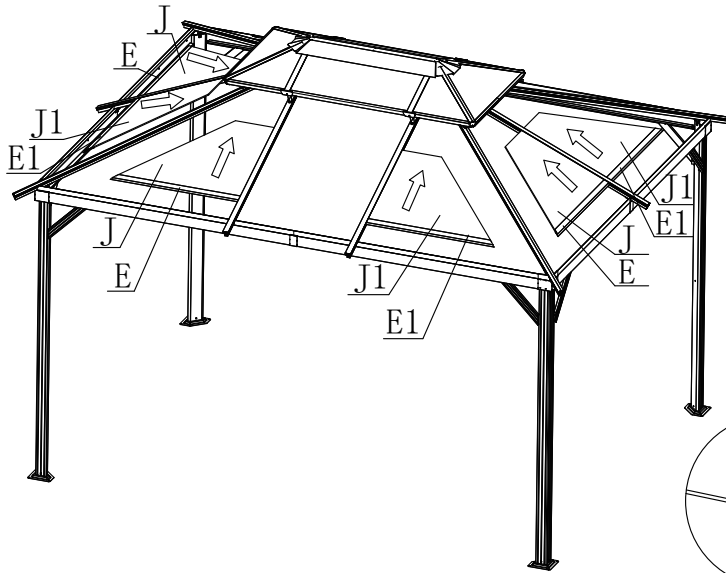

Refer to diagram install the E/E1
Narrow side top ↑ / Wide side base ↓

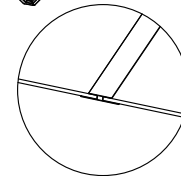

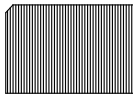
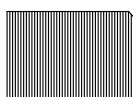

No.	Qty	Picture	No.	Qty	Picture
J2	4		J3	4	

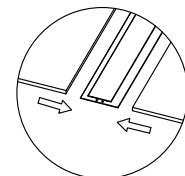
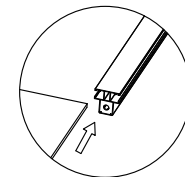
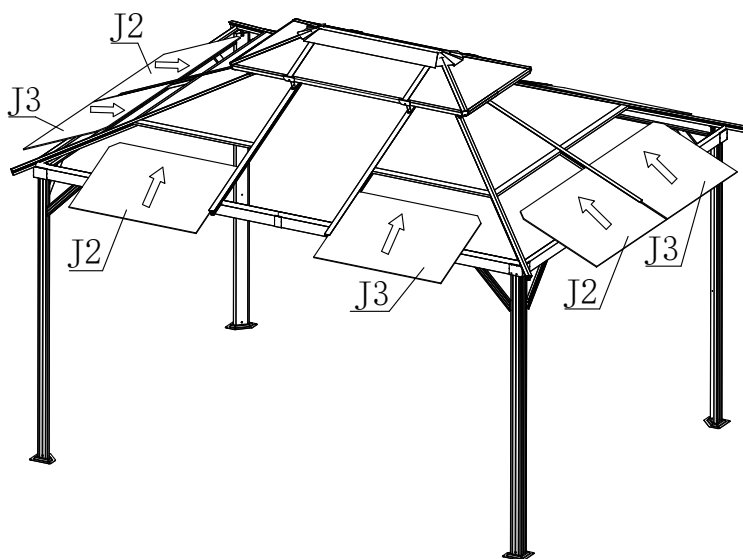
Step24



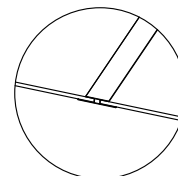

Refer to diagram install the E/E1
Narrow side top ↑ / Wide side base ↓

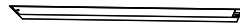
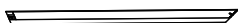

No.	Qty	Picture	No.	Qty	Picture
K	4		K1	4	
E2	4		E3	4	

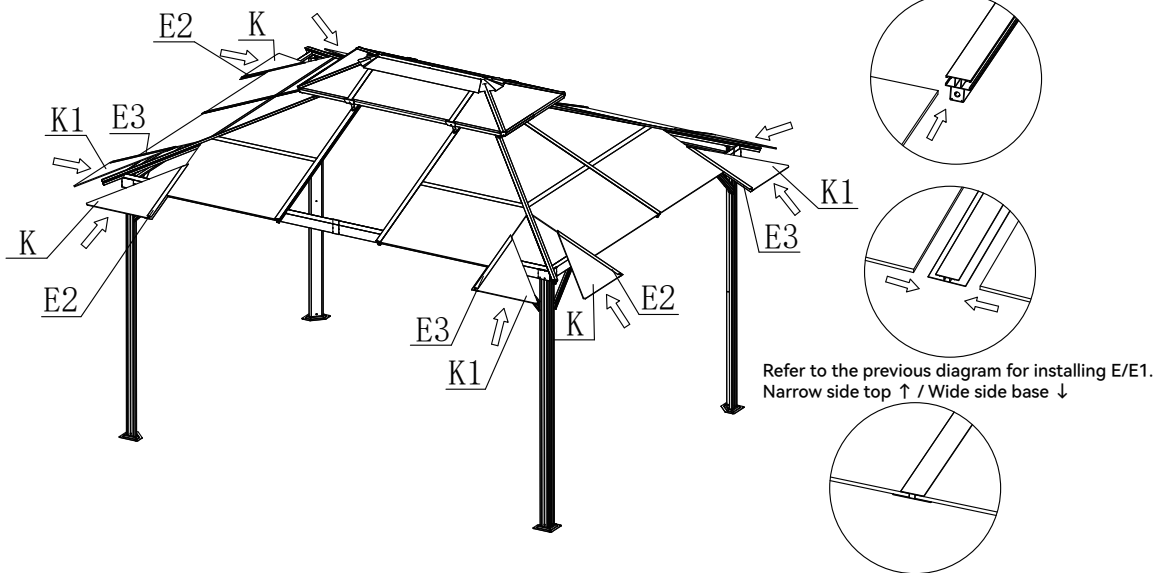

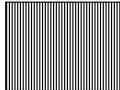

Step25

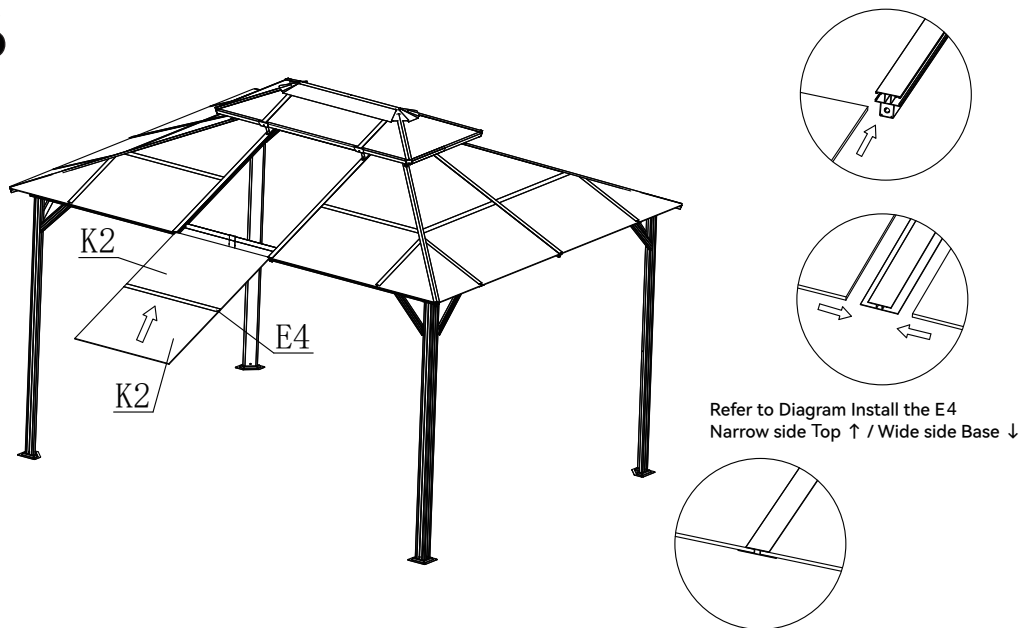

No.	Qty	Picture	No.	Qty	Picture
K2	4		E4	2	



Step26

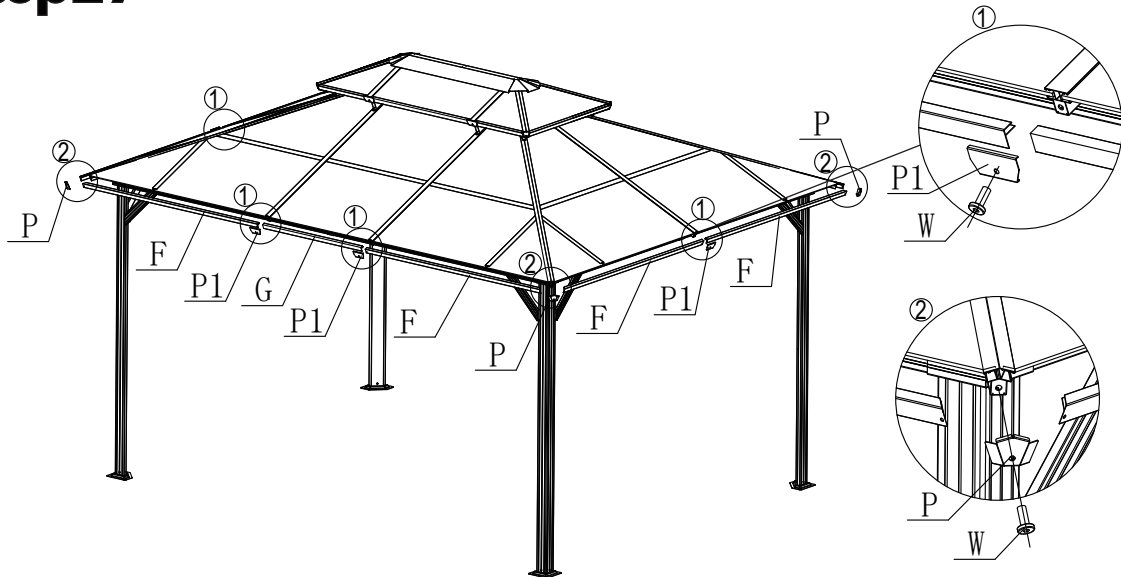

No.	Qty	Picture	No.	Qty	Picture
F	8		P	4	
F1	2		P1	6	
			W	10	 M6 * 15 mm

Step27



No.	Qty	Picture	No.	Qty	Picture
U	80		U1	8	 Ø11 * Ø 6* 20mm
X	8	 M6 * 35 mm			

Step28

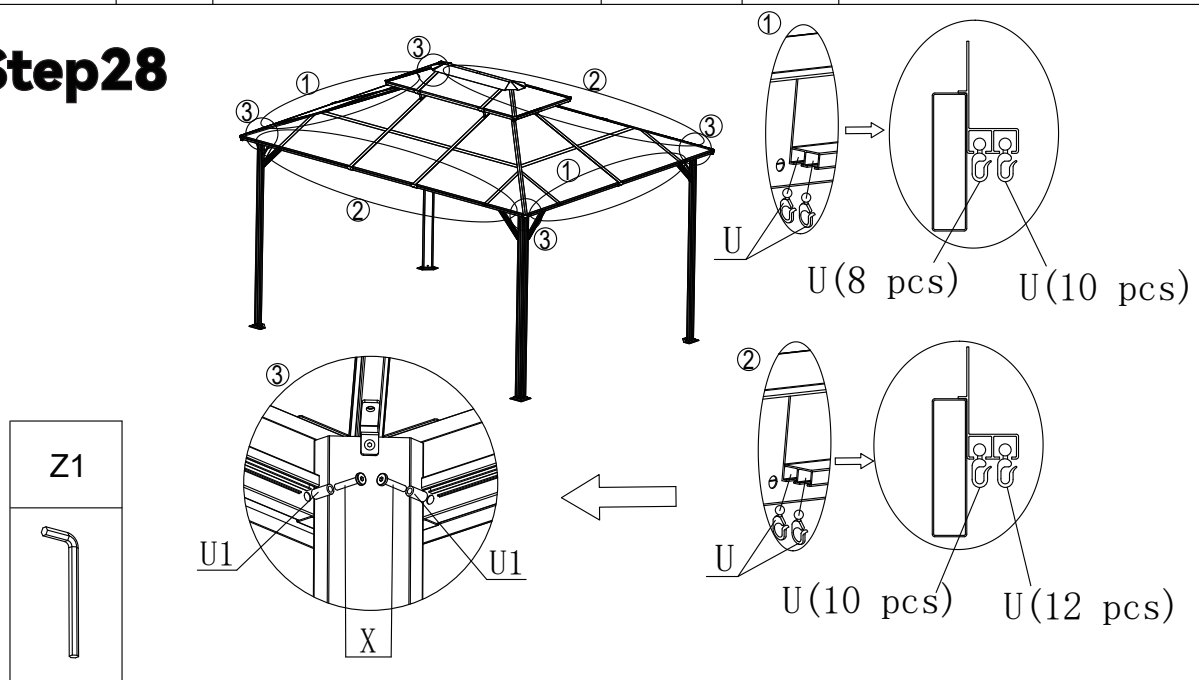

No.	Qty	Picture
S	4	 Curtain

Step29

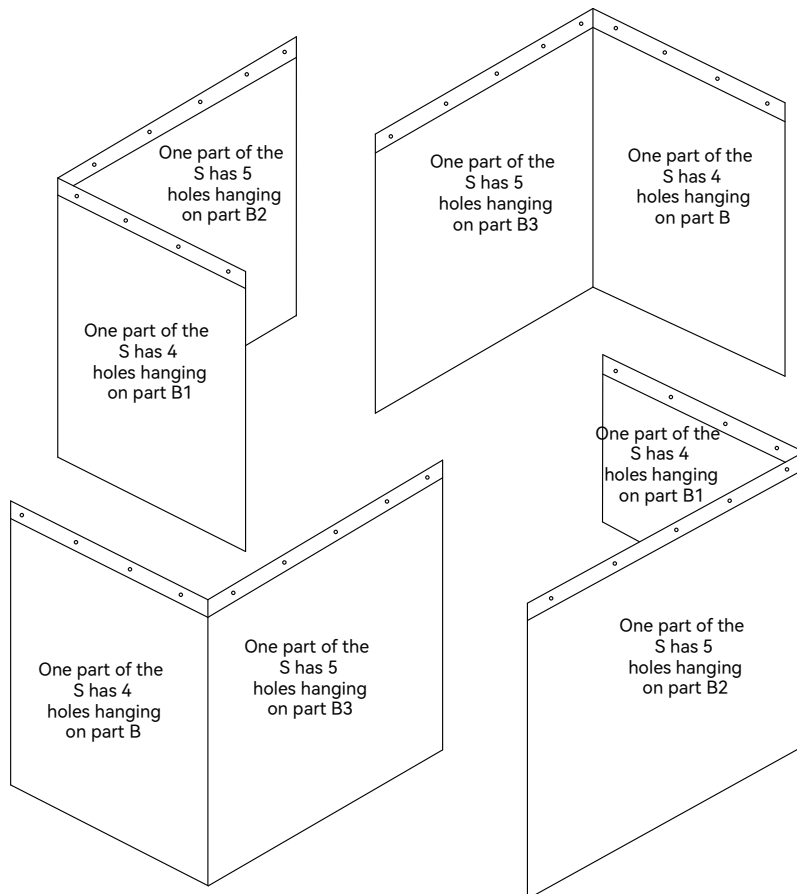

Step30

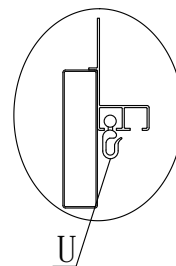
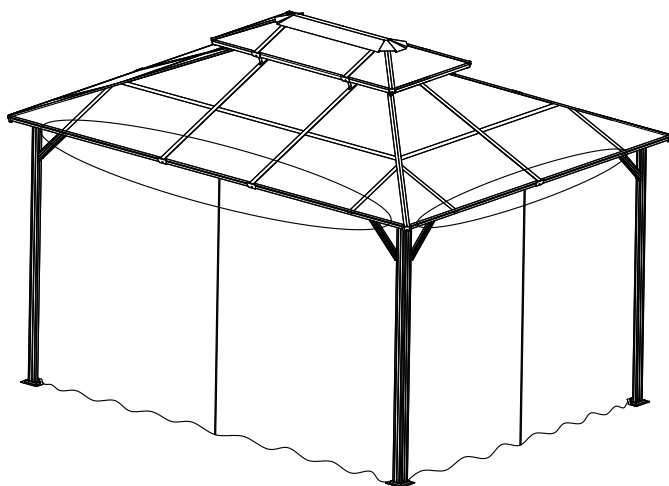

Pay attention to the sidewall curtain's installation position.

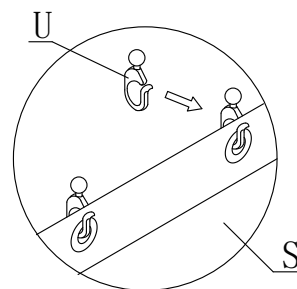

No.	Qty	Picture
T	4	

Step31

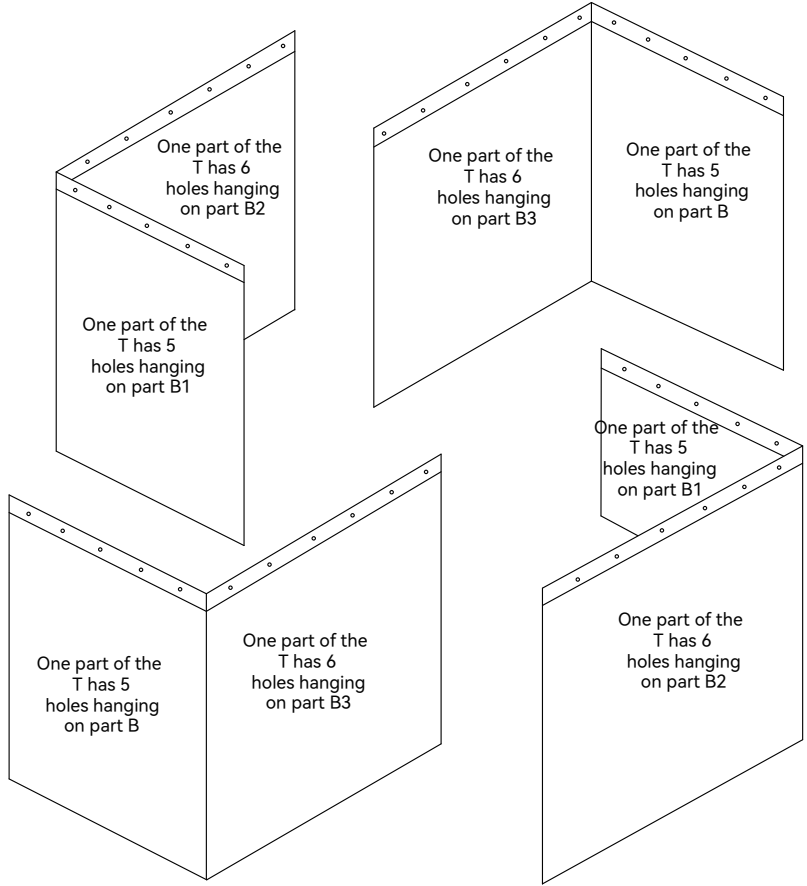

Step32

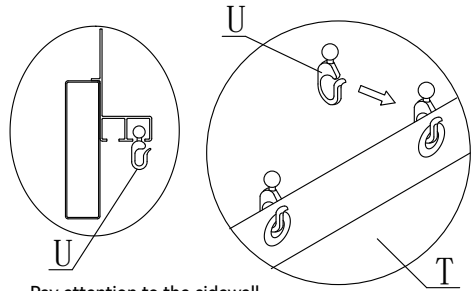
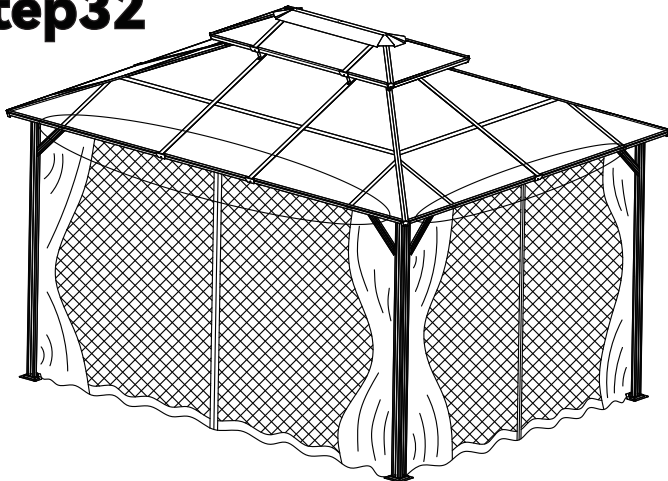

Pay attention to the sidewall netting's installation position.

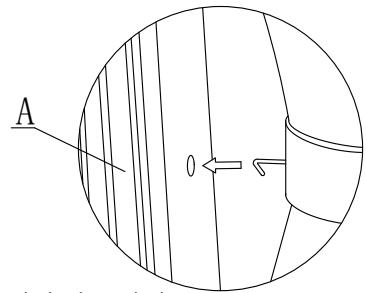

Hang the hook attached to the netting on Part A.

No.	Qty	Picture
Z	12	

Step33

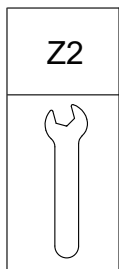
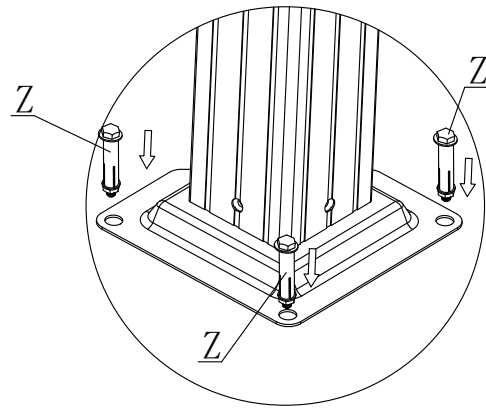
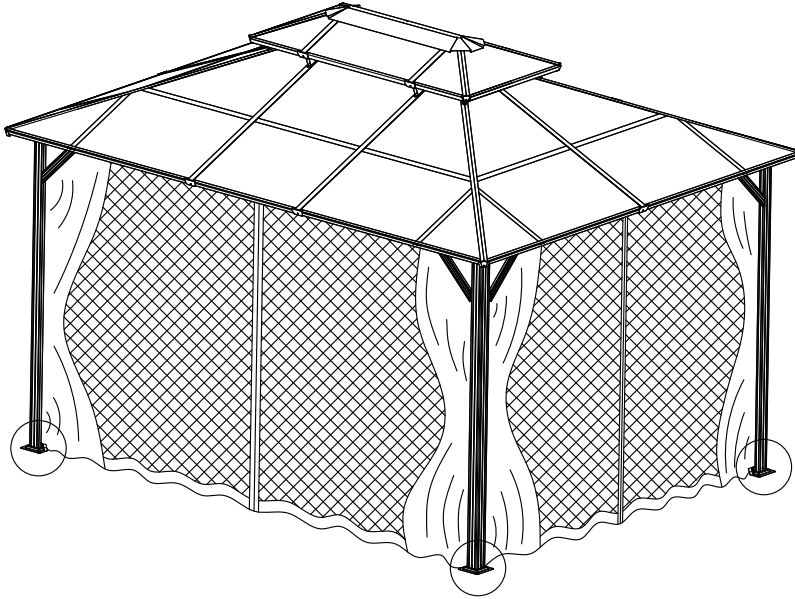

EROMMY!

Closer to Life!

