

MODEL: IG1060094C-1014-WLY

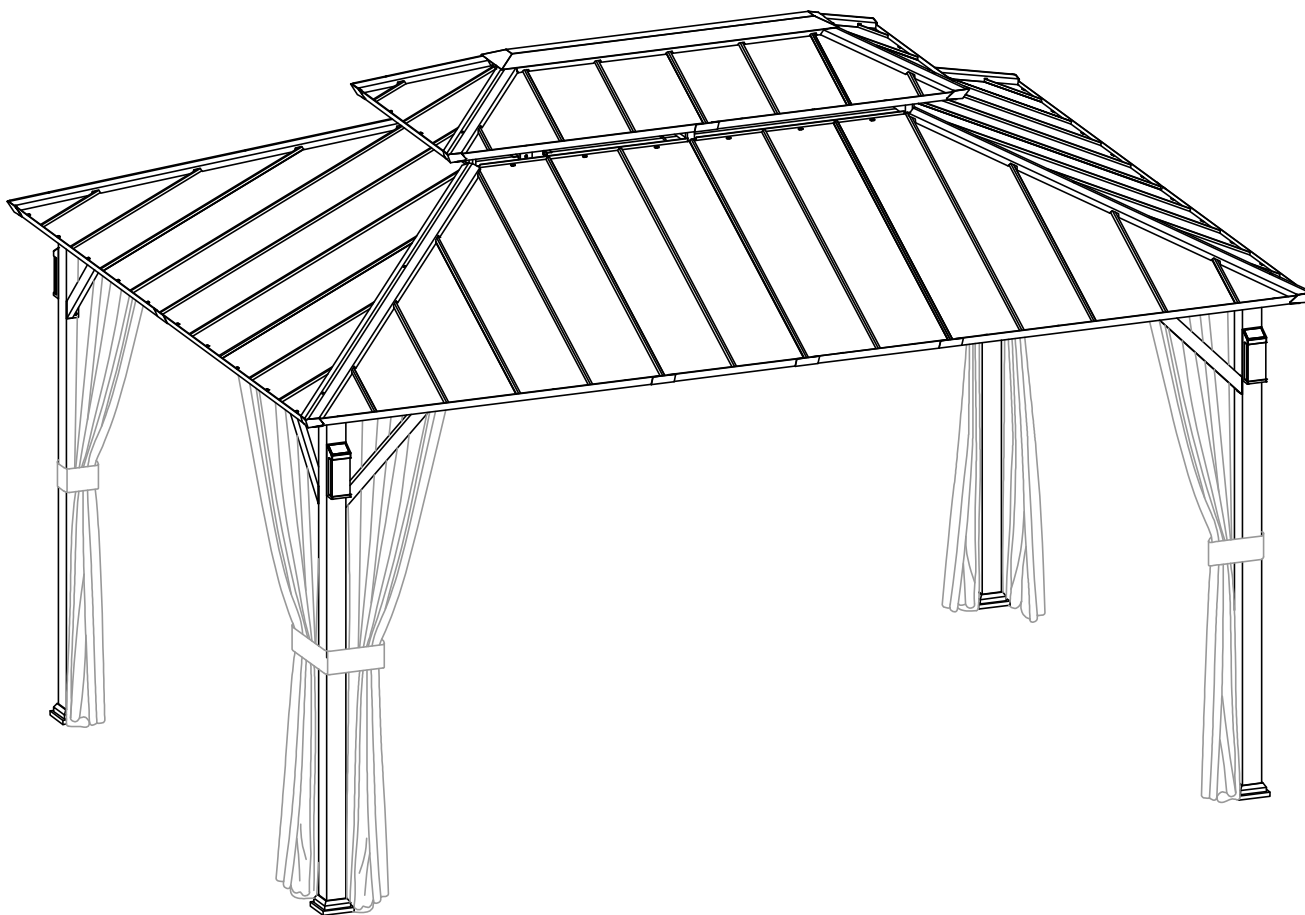

OWNER'S MANUAL

The Horizon 10'x14' Hard Top Gazebo W/ Solar LED light

TABLE OF CONTENTS

ASSEMBLY GUIDE.....	02
USING YOUR PRODUCT.....	04

March 27, 2025

QUESTIONS?



E-mail: support@modernshade.org







Toll Free: 1-888-666-3070

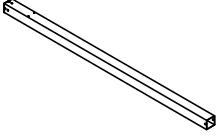
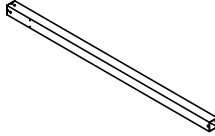
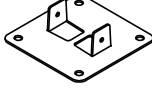
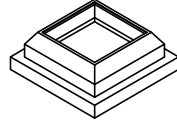
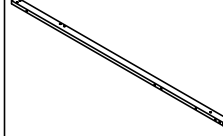
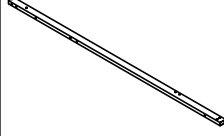
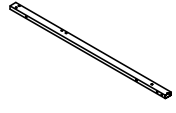
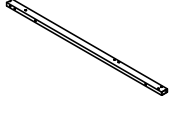
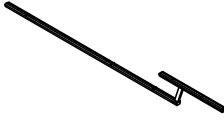
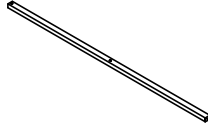
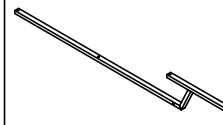
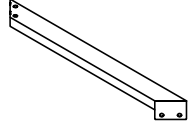
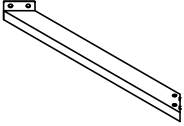
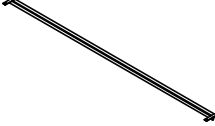
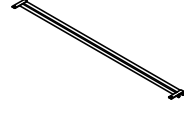
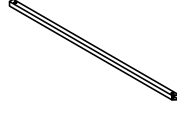
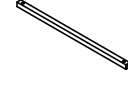
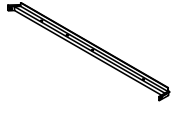
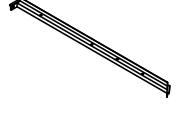
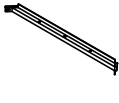
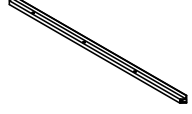
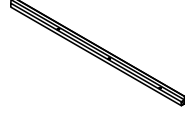
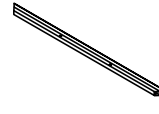
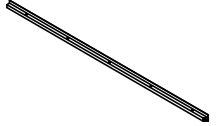
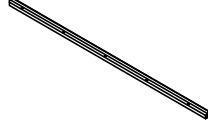

Mon-Fri: 9am---5pm PST.

ASSEMBLY GUIDE

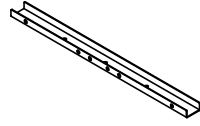
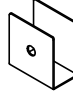
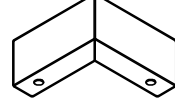
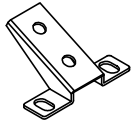
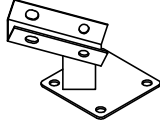
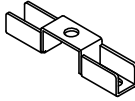
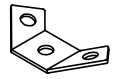
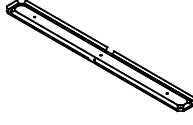
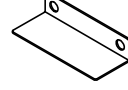
PARTS LIST

A1 Post 1 (2 pieces) 	A2 Post 2 (2 pieces) 	B Foot Base (4 pieces) 	C Foot Cover (4 pieces) 	D1 Cross Beam 1 (2 pieces) 	D2 Cross Beam 2 (2 pieces) 
P0010000102	P0010000202	P0030000101	P0020000101	P0040000302	P0040000402
D3 Cross Beam 3 (2 pieces) 	D4 Cross Beam 4 (2 pieces) 	E Roof Rib (4 pieces) 	F1 Middle Cross Beam 1 (6 pieces) 	F2 Middle Cross Beam 2 (2 pieces) 	G1 Support Bracket 1 (4 pieces) 
P0040000502	P0040000602	P0070000101	P0080000101	P0080000201	P0050000102
G2 Support Bracket 2 (4 pieces) 	H1 Mosquito Net Rod 1 (4 pieces) 	H4 Mosquito Net Rod 2 (4 pieces) 	J2 Top Beam 1 (8 pieces) 	J3 Top Beam 2 (4 pieces) 	K1 Roof Support 1 (2 pieces) 
P0050000202	P0100000201	P0100000501	P0090000201	P0090000301	P0090000601
K2 Roof Support 2 (2 pieces) 	K4 Roof Support 3 (2 pieces) 	K6 Roof Support 4 (2 pieces) 	K7 Roof Support 5 (2 pieces) 	K8 Roof Support 6 (2 pieces) 	K10 Roof Support 7 (4 pieces) 
P0090000701	P0090000901	P0090001101	P0090001201	P0090001301	P0090001501
K11 Roof Support 8 (4 pieces) 	K14 Roof Support 9 (4 pieces) 	L1 Connector 1 (4 pieces) 	L2 Connector 2 (4 pieces) 	L3 Connector 3 (4 pieces) 	L4 Connector 4 (8 pieces) 
P0090001601	P0090001901	P0060000101	P0110000102	P0110000302	P0060000301
L5 Connector 5 (4 pieces) 	L6 Connector 6 (18 pieces) 	L7 Connector 7 (12 pieces) 	L8 Connector 8 (1 piece) 	L9 Connector 9 (10 pieces) 	M1 Roof Rib Cover 1 (4 pieces) 
P0060000401	P0060000501	P0060000601	P0060000801	P0110000501	P0120000101

ASSEMBLY INSTRUCTIONS

•Please carefully unpack each of the components and hardware. check the components against the parts list and make sure there are no missing parts. lay pieces on cardboard or a soft mat to help protect the pieces from scratches.

CAUTION

Watch for sharp edges when handling the pieces, wear gloves to avoid injury.

STEP 01 Slide Foot Cover **C** onto Post 1 **A1**. Attach Foot Base **B** using two (2) M6*20 Bolts **AA** and two (2) M6 Flat Washers **DD**. Repeat for the second Post 1 **A1**. Slide Foot Cover **C** onto Post 2 **A2**. Attach Foot Base **B** using two (2) M6*20 Bolts **AA** and two M6 Flat Washers **DD**. Repeat for the second Post 2 **A2**.

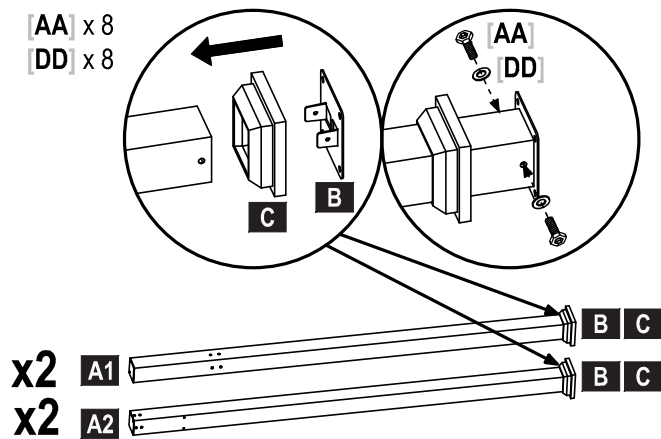

STEP 03 Slide Cross Beam 3 **D3** and Cross Beam 4 **D4** onto the ends of Connector 1 **L1**, then place one (1) Connector 2 **L2** over the assembly. Connect together using five (5) M6*20 Bolts **AA** and five (5) M6 Flat Washers **DD**. Repeat to create a second assembly.

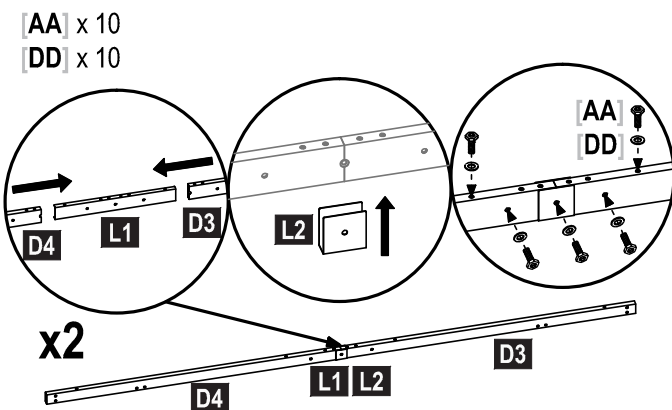

- For ease of assembly, it is recommended to have 3 or more people and allow enough time to completely finish the assembly. assembly can take 6-8 hours. a step-ladder is required for assembly (not included).
- Follow step by step instructions, and follow all safety warnings provided with your tools.
- DO NOT tighten screws until all the screws and washers are properly installed. Tighten screws securely, do not over tighten.
- Gazebo should not be used in inclement weather and high winds.

STEP 02 Slide Cross Beam 1 **D1** and Cross Beam 2 **D2** onto the ends of Connector 1 **L1**, then place one (1) Connector 2 **L2** over the assembly. Connect together using five (5) M6*20 Bolts **AA** and five (5) M6 Flat Washers **DD**. Repeat to create a second assembly.

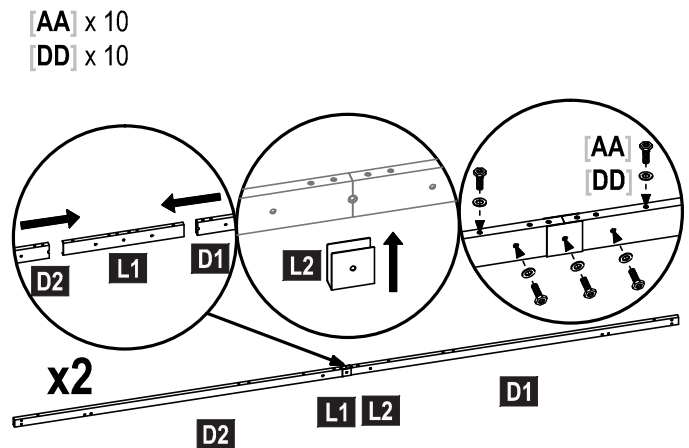

STEP 04 Connect the assembly from Step 2 **D1** + **D2** to Post 1 **A1** and Post 2 **A2** using four (4) M6*20 Bolts **AA** and four (4) M6 Flat Washers **DD**. Repeat to create a second set of legs.

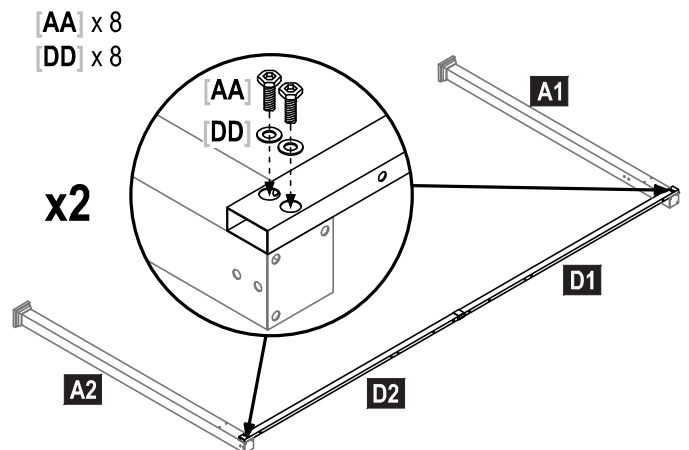

STEP 05 Connect the sets of legs from Step 4 together using the assemblies from Step 3 **D3** + **D4** using eight (8) M6*20 Bolts **AA** and eight (8) M6 Flat Washers **DD**.

AA x 8
DD x 8

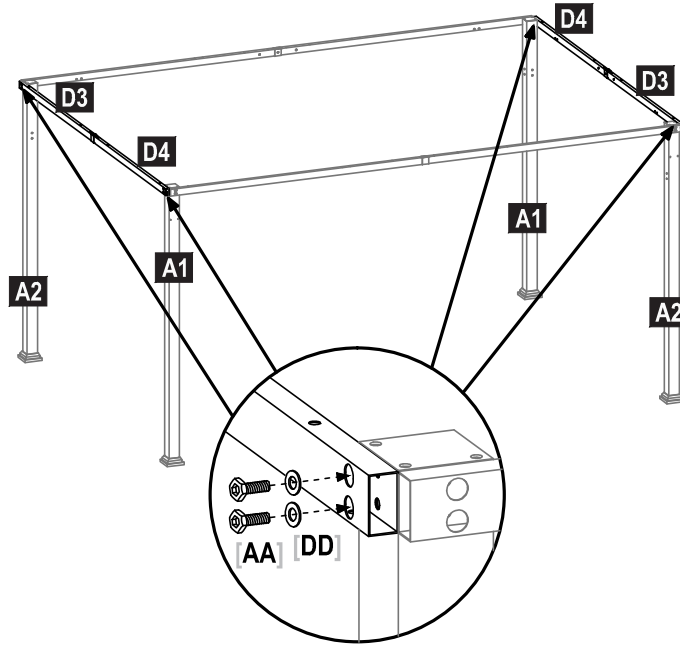

**STEP 06 CRITICAL: SQUARE UNIT BEFORE PROCEEDING TO NEXT STEPS.
ONCE SQUARE, TIGHTEN ALL HARDWARE.**

