







Assembly instructions for the chair, including safety warnings, estimated time, and required personnel.

Warning 1: Do not use a power drill on the L-shaped corner brackets. 

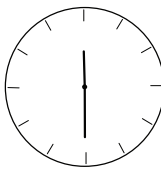
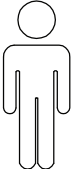
Warning 2: Do not use a power drill on the seat base. 

Estimated Time: 30' 

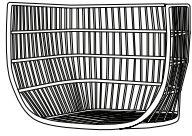
Required Personnel: 2 

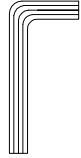
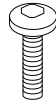
A	B	C	D	E
				 M10 x 13
x1	x1	x1	x1	x4

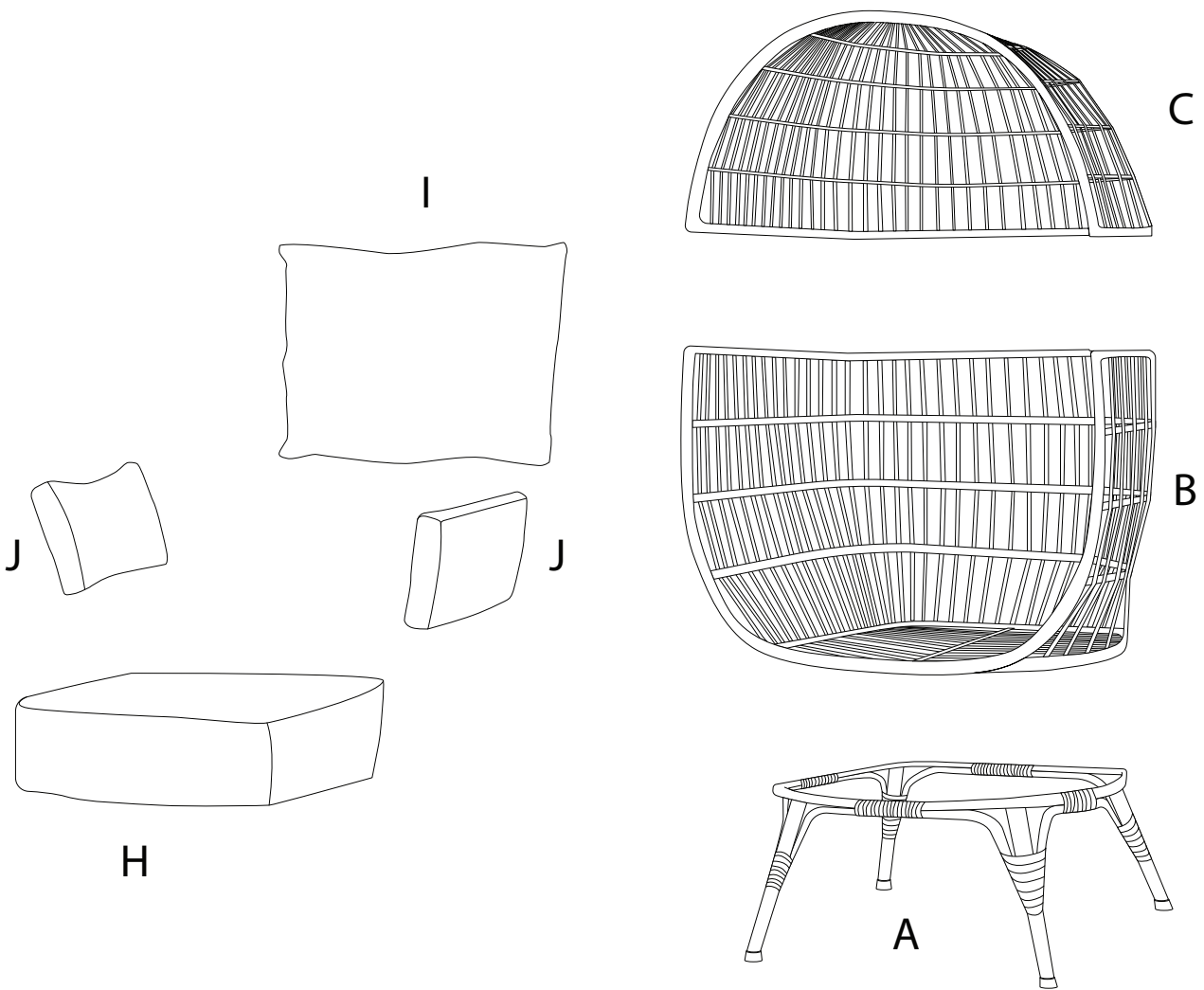

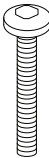
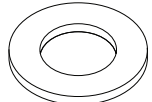
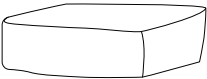
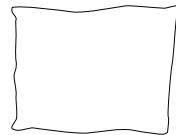
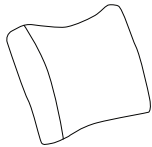
F	G	H	I	J
 M10 x 27				
x4	x8	x1	x1	x2

1

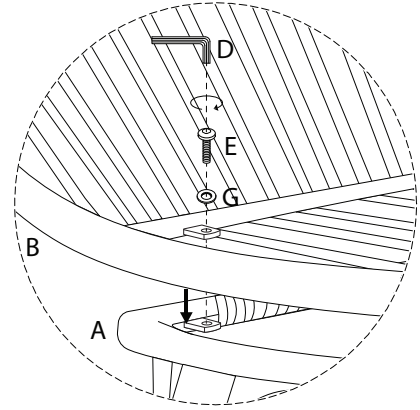
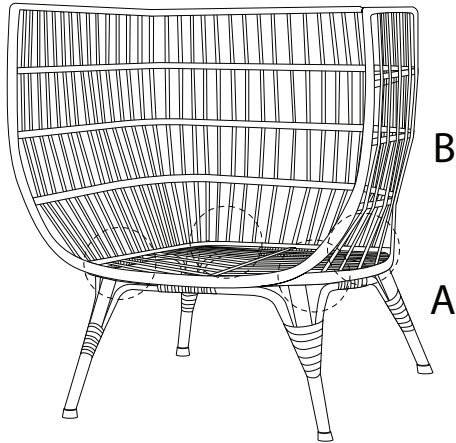
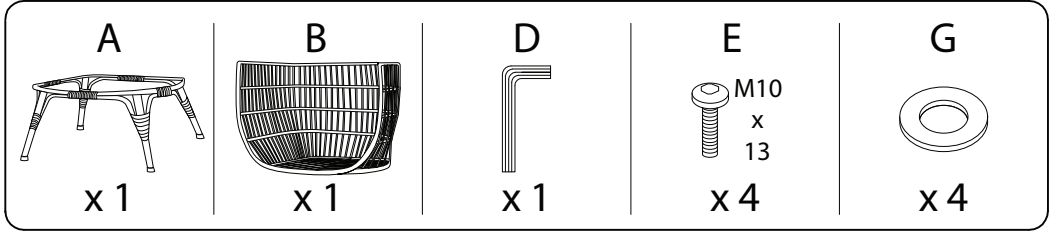

2

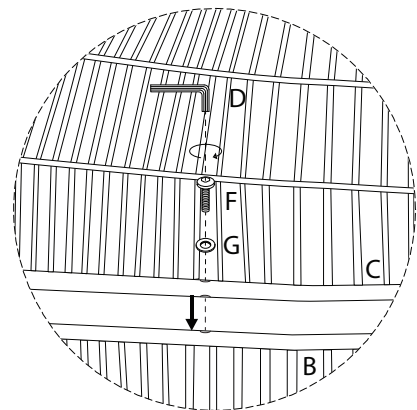
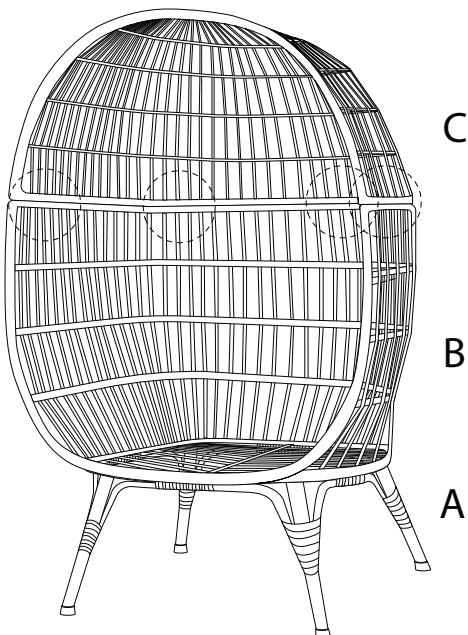
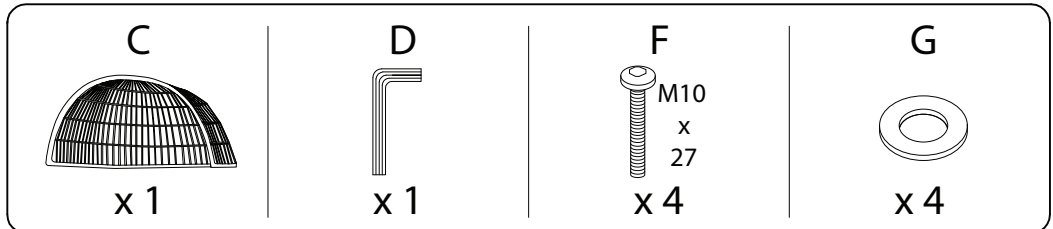

3

H

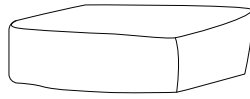

x 1

H

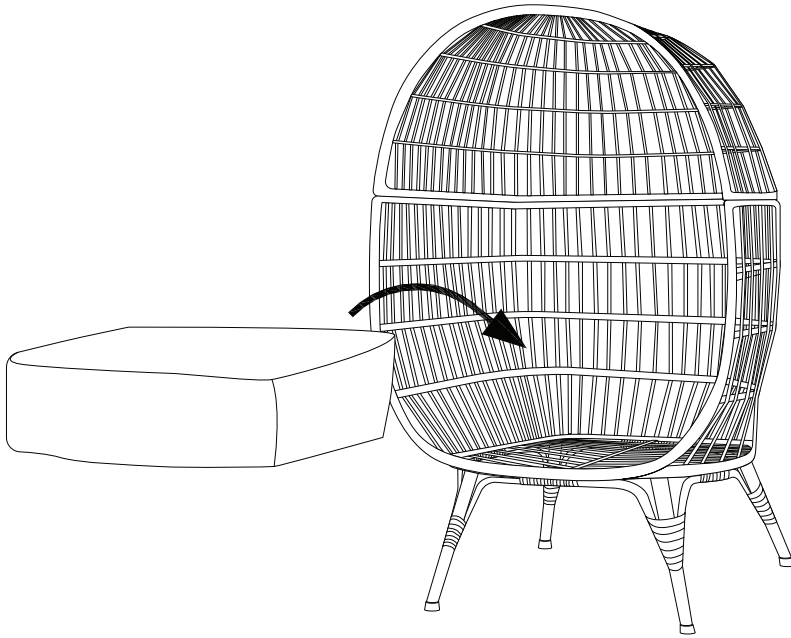

4

I

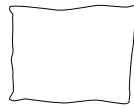

x 1

I

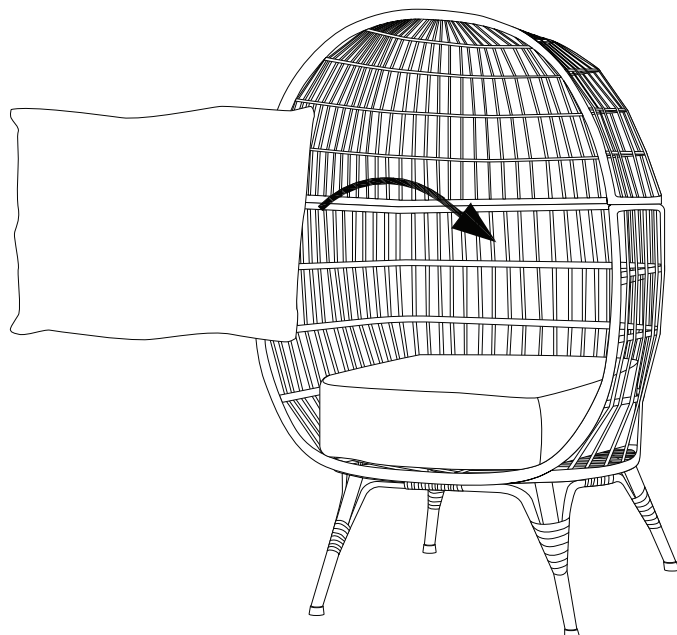

5

J

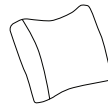

x2

