

ASSEMBLY INSTRUCTIONS

TOOLS REQUIRED

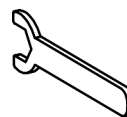

Wrench
(Included)

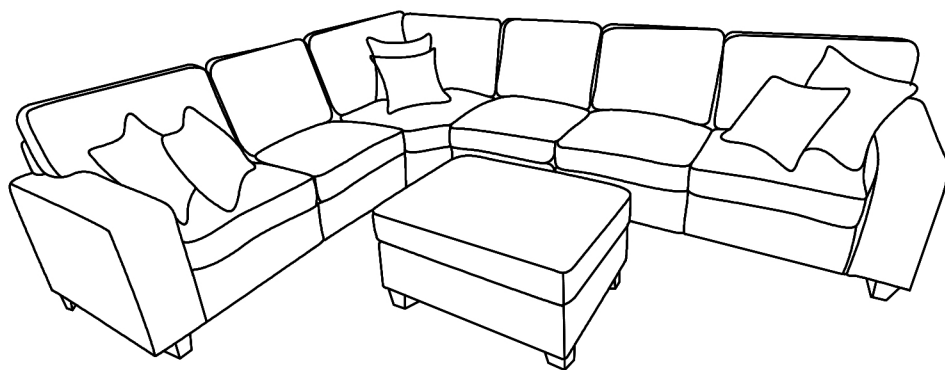

**2 - People
Recommended**

ASSEMBLY RATING



EASY → DIFFICULT

The Assembly Rating is a 5-point system showing the level of effort needed to assemble a specific product.



CHECK BEFORE STARTING

Are you missing anything?

Double-check all parts, hardware and accessories listed are all accounted for.

Should we send any replacements?

Are there any irregularities or flaws in the parts? We can send replacements!

Check out our Quick Tips!

We recommend reviewing the pre-assembly handouts. Even experts need a refresher now and then!

Prep Time!

Please review the assembly instructions and all diagrams prior to assembling.

PRE ASSEMBLY INTRODUCTION

We understand building ready-to-assemble furniture can be a challenging experience for some. To help avoid confusion, we have provided some helpful tips that may speed up the process.

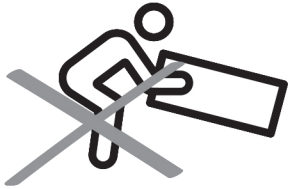

Teamwork

ALWAYS have at least two people to help with transporting and assembling the product to avoid potential injury and/or damage.

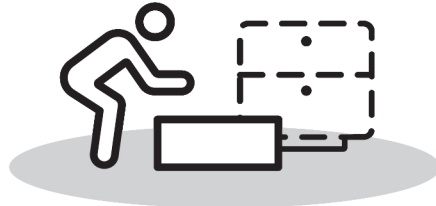
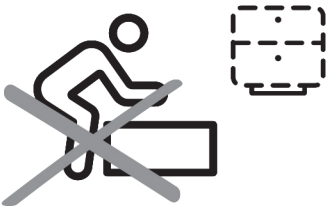

Suitable Location

Assembling near the area of the intended location is highly recommended.



Sufficient Space

Make sure you have enough space to move around during the assembly.

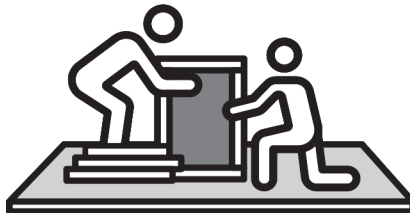

Avoid Scratches

Use cardboard, blankets or a carpeted area while assembling furniture to prevent to prevent scratches and damages.

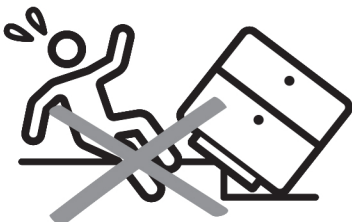

Flat Surface

Make sure the furniture rests on a flat and level surface with each leg evenly touching the floor.

ASSEMBLY AND CARE ADVICE



FAILURE TO FOLLOW THE GUIDELINES BELOW MAY RESULT IN INJURY AND/OR PROPERTY DAMAGE.



Position each part correctly and insert screws or bolts into their respective holes.

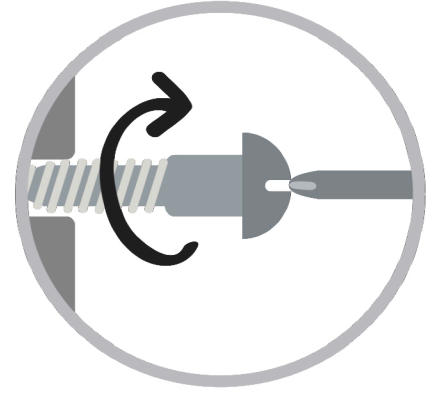

Turn clockwise to tighten and only tighten when step is completed or when instructed to do so.



Use the appropriate hand tools or power tools for assembly. Select steps, such as tightening screws and/or bolts, may require hand tools to avoid causing damage during assembly.



Save the instructions and store any supplied tools for later maintenance.

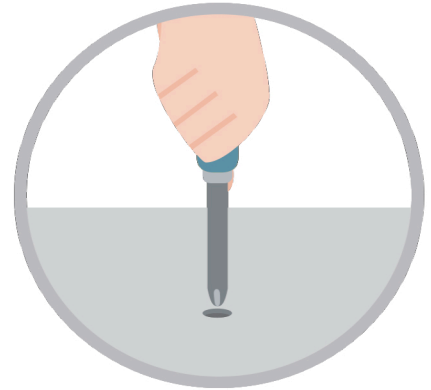

After two weeks, check and tighten any loose hardware and repeat again every six months thereafter.

IT IS THE USER'S RESPONSIBILITY TO MAINTAIN THE FURNITURE. THE HARDWARE MAY LOOSEN OVER TIME AND MAY CAUSE THE FURNITURE TO BE WOBBLY AND UNABLE TO SUPPORT ITS INTENDED WEIGHT CAPACITY. THIS MAY LEAD TO COLLAPSE AND MAY CAUSE SERIOUS INJURY.

SOFA



- Please keep instructions for future reference.
- Check the quantity and irregularity of parts and hardware before you start.

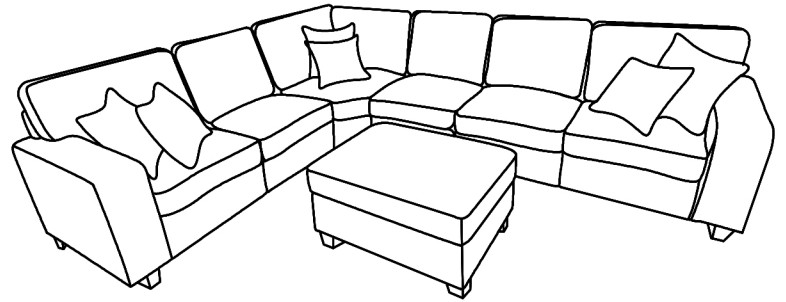

PARTS

#1 1pc

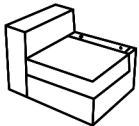

Left Sofa Seat

#2 1pc

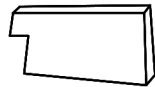

Left Sofa Back Rest

#3 1pc



Left Sofa Back Cushion

#4 3pcs

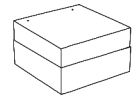

Chair Seat

#5 3pcs



Chair Back Rest

#6 3pcs



Chair Back Cushion

#7 1pc

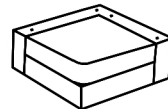

Corner seat

#8 1pc

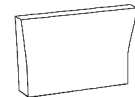

Corner right back rest

#9 1pc

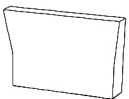

Corner left back rest

#10 1pc



Corner right back cushion

#11 1pc



Corner left back cushion

#12 1pc

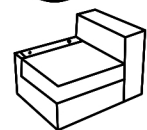

Right Sofa Seat

#13 1pc



Right Sofa Back Rest

#14 1pc



Right Sofa Back Cushion

#15 3pcs



Small Pillow

#16 3pcs



Big Pillow

#17 1pc



Ottoman

#18 27pcs

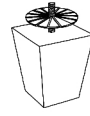

Plastic leg

#19 2pcs



Front leg

HARDWARE

#A 14pcs



Flat washer
Ø5/16 x 22mm

#B 14pcs



Nut
Ø5/16 x 12mm

#C 14pcs



Bolt
Ø5/16 x 90mm

#D 1pc

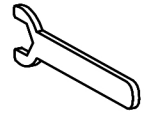





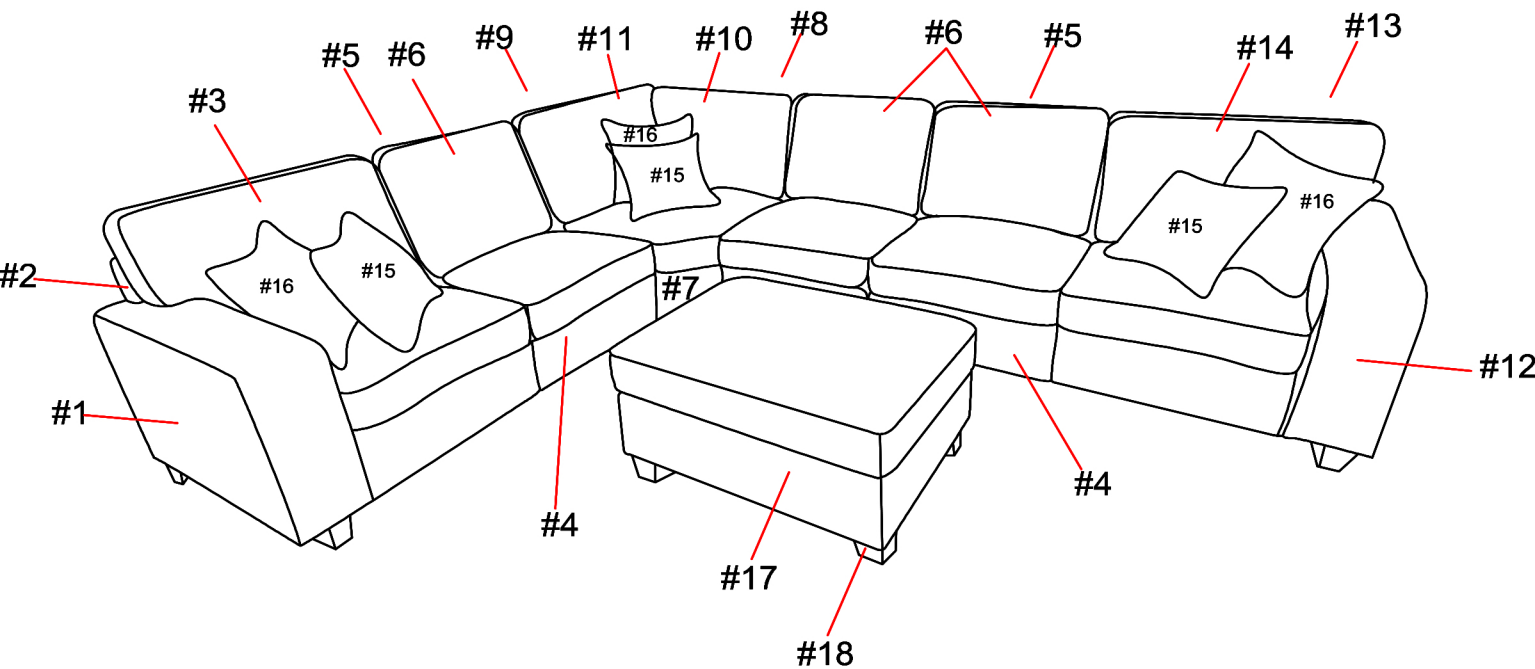





































Open wrench

Exploded View



packed in 7 cases

Carton	Disignation	Part	Hardware
	Right Sofa Seat		
	Back Rest		 #A 2pcs
	Back Cushion		 #B 2pcs
	Pillow		 #C 2pcs
	Pillow		 #D 1pc
	Plastic Leg		
	Left Sofa Seat		
	Back Rest		 #A 2pcs
	Back Cushion		 #B 2pcs
	Pillow		 #C 2pcs
	Pillow		 #D 1pc
	Plastic Leg		
	Chair Seat		 #A 2pcs
	Back Rest		 #B 2pcs
	Back Cushion		 #C 2pcs
	Plastic Leg		 #D 1pc
	Ottoman		
	Plastic Leg		
	Corner Seat		
	Corner Right Back Rest		
	Corner Left Back Rest		 #A 4pcs
	Corner Right Back Cushion		 #B 4pcs
	Corner Left Back Cushion		 #C 4pcs
	Pillow		 #D 1pc
	Pillow		
	Plastic Leg		
	Front Leg		

ASSEMBLY INSTRUCTIONS

1

Part #2 x1pc
Hardware #C x2pcs

Twist the Threaded bolt (#C) onto the Left Sofa Back rest (#2).

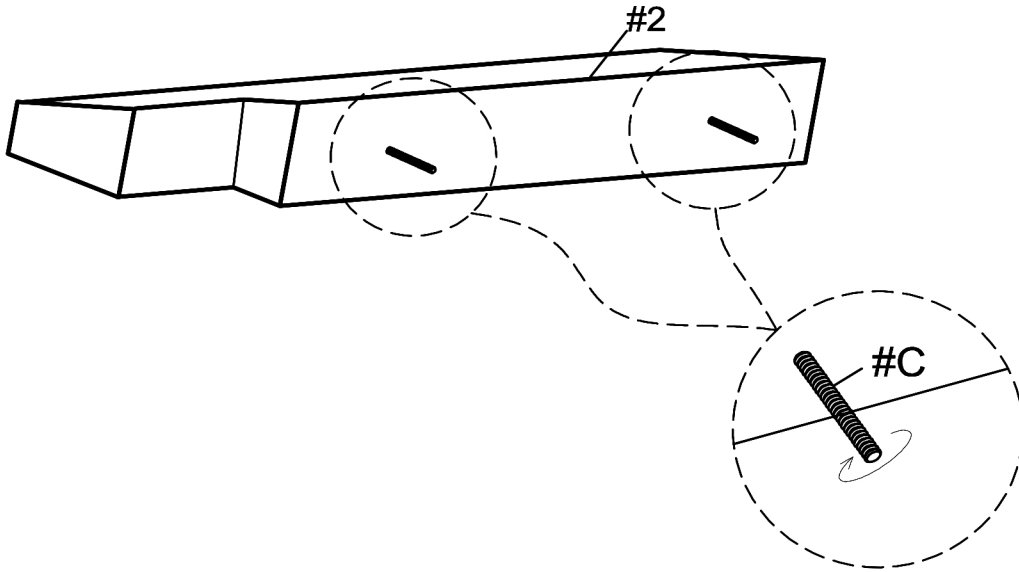

2

Part #1 x1pc
Part #18 x4pcs
Hardware #A x2pcs
Hardware #B x2pcs
Hardware #C x2pcs

Insert the Left Sofa Back Rest (#2) into the Left Sofa Seat (#1). Secure by using Flat washer (#A) with Nut (#B). Attach the Plastic Leg (#18) to the Left sofa Seat (#1). Lift upright and place the Left Sofa back Cushion (#3).

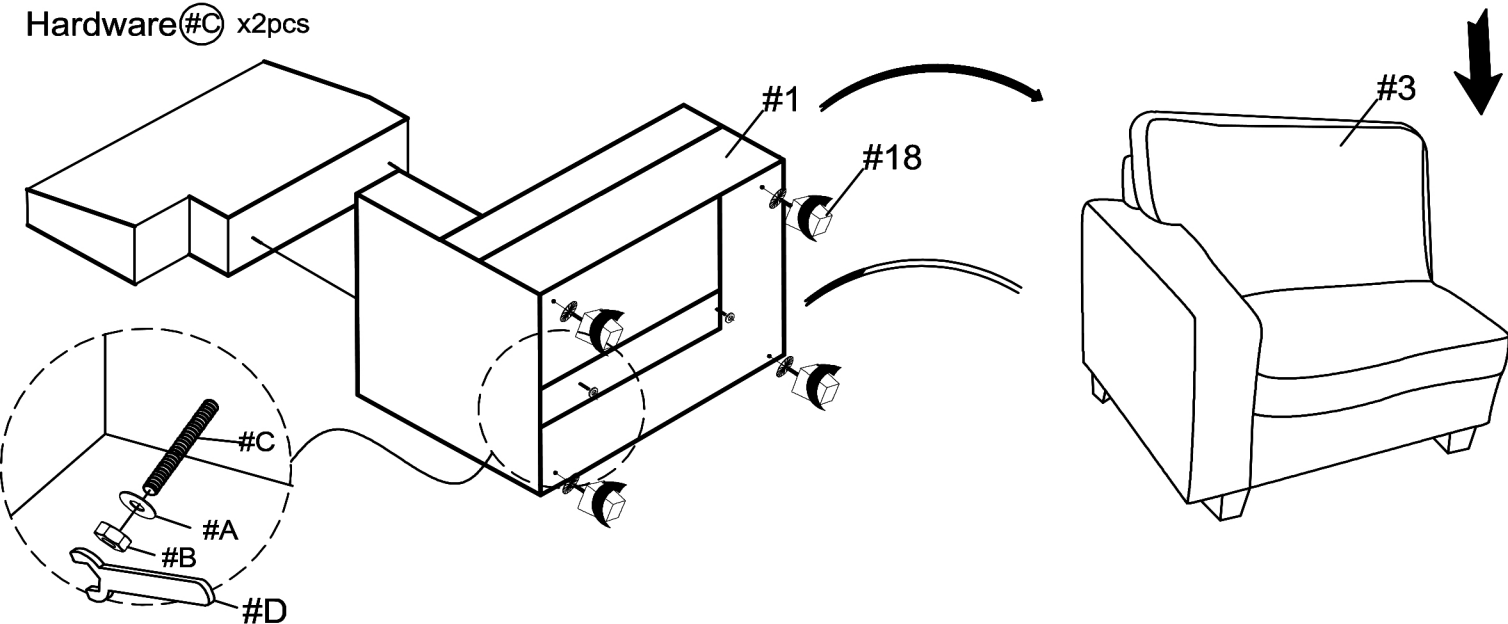

ASSEMBLY INSTRUCTIONS

3

Part #5 x3pcs
Hardware #C x6pcs

Twist the Threaded bolt (#C) onto the Chair Back Rest (#5).

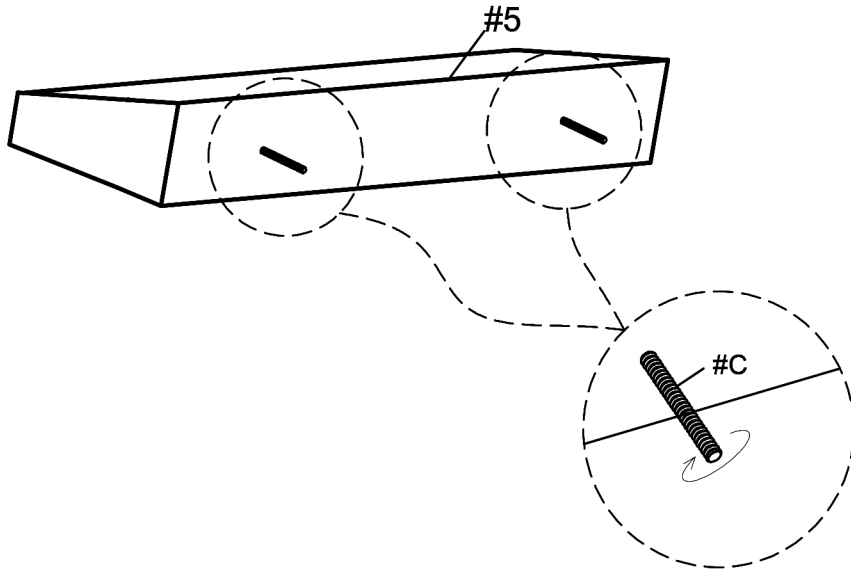

4

Part #4 x3pcs
Part #18 x12pcs
Hardware #A x6pcs
Hardware #B x6pcs
Hardware #C x6pcs

Insert the Chair Back Rest (#5) into the Chair Seat (#4). Secure by using Flat washer (#A) with Nut (#B). Attach the Plastic Leg (#18) to the Chair Seat (#4). Lift upright and place the Chair Back Cushion (#6).

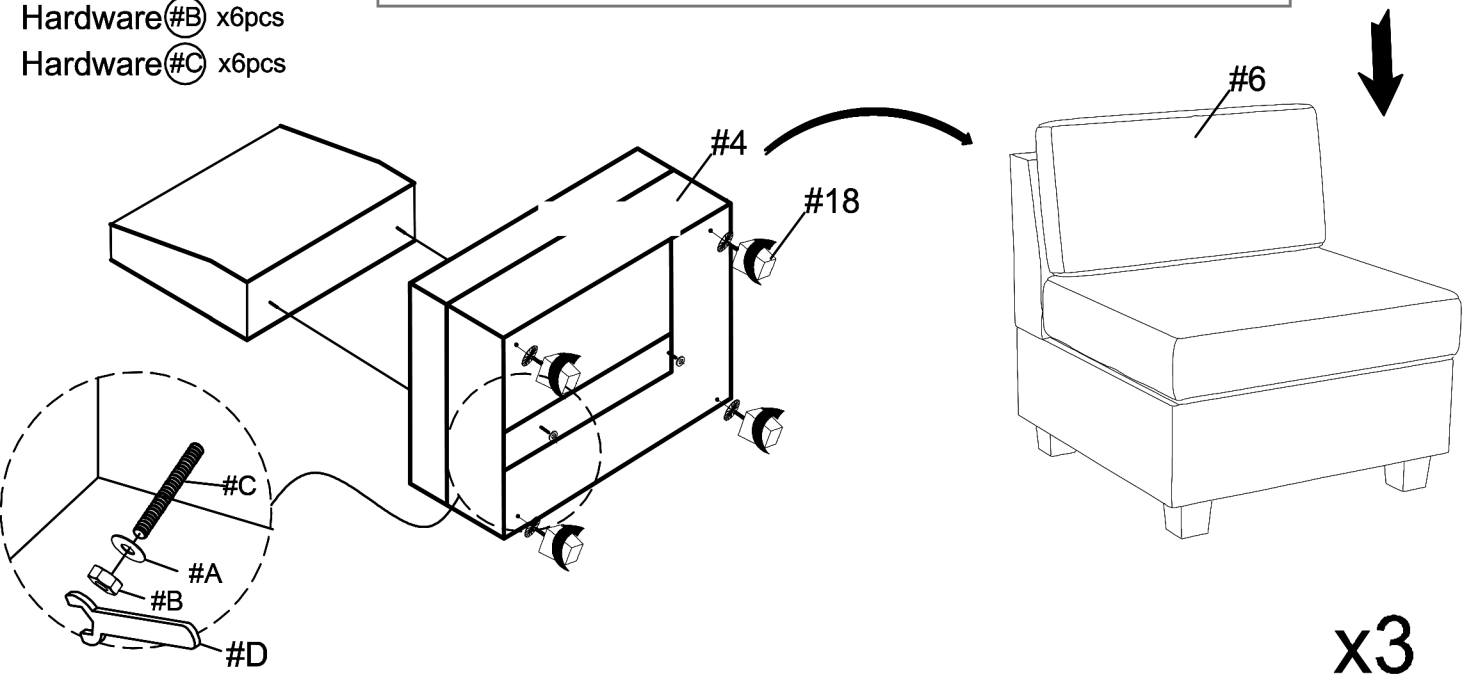

ASSEMBLY INSTRUCTIONS

5

Part #8 x1pc

Part #9 x1pc

Hardware #C x4pcs

Twist the Threaded bolt (#C) onto the Left/ Right Corner Back Rest (#8,#9).

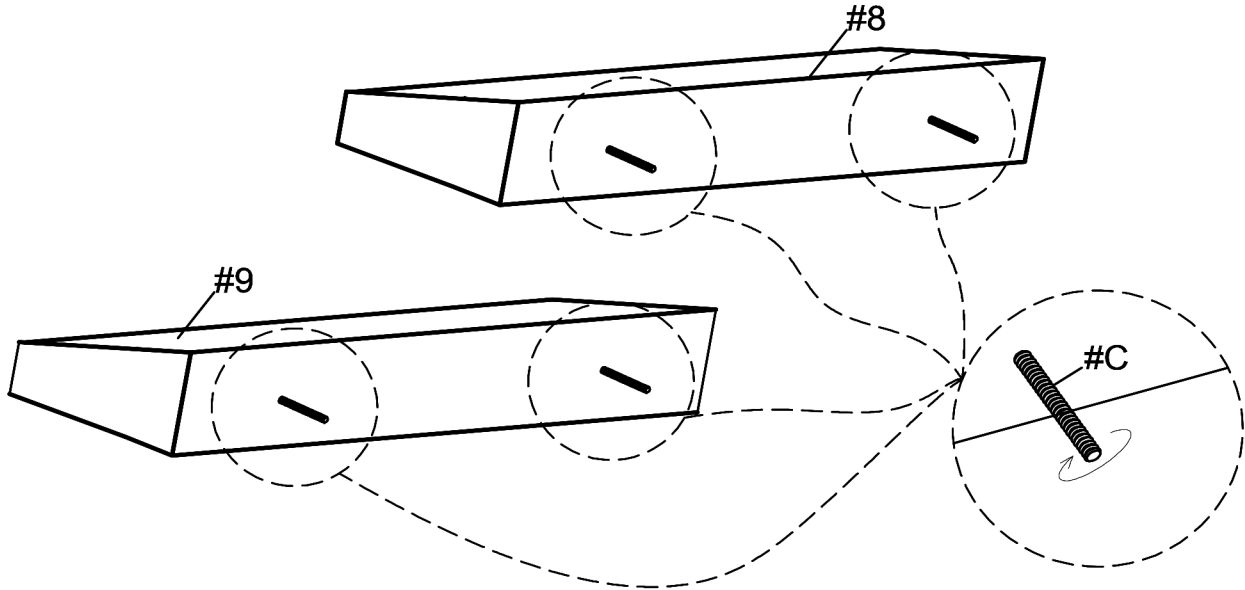

6

Part #7 x1pc

Part #18 x3pcs

Part #19 x2pcs

Hardware #A x4pcs

Hardware #B x4pcs

Hardware #C x4pcs

Insert the Left/ Right Corner Back Rest (#8, #9) into the Corner Seat (#7). Secure by using Flat washer (#A) with Nut (#B). Attach the Plastic Leg (#18) and Front Leg (#19) to the Corner Seat (#7). Lift upright and place the Left/ Right Corner Back Cushion (#10,#11).

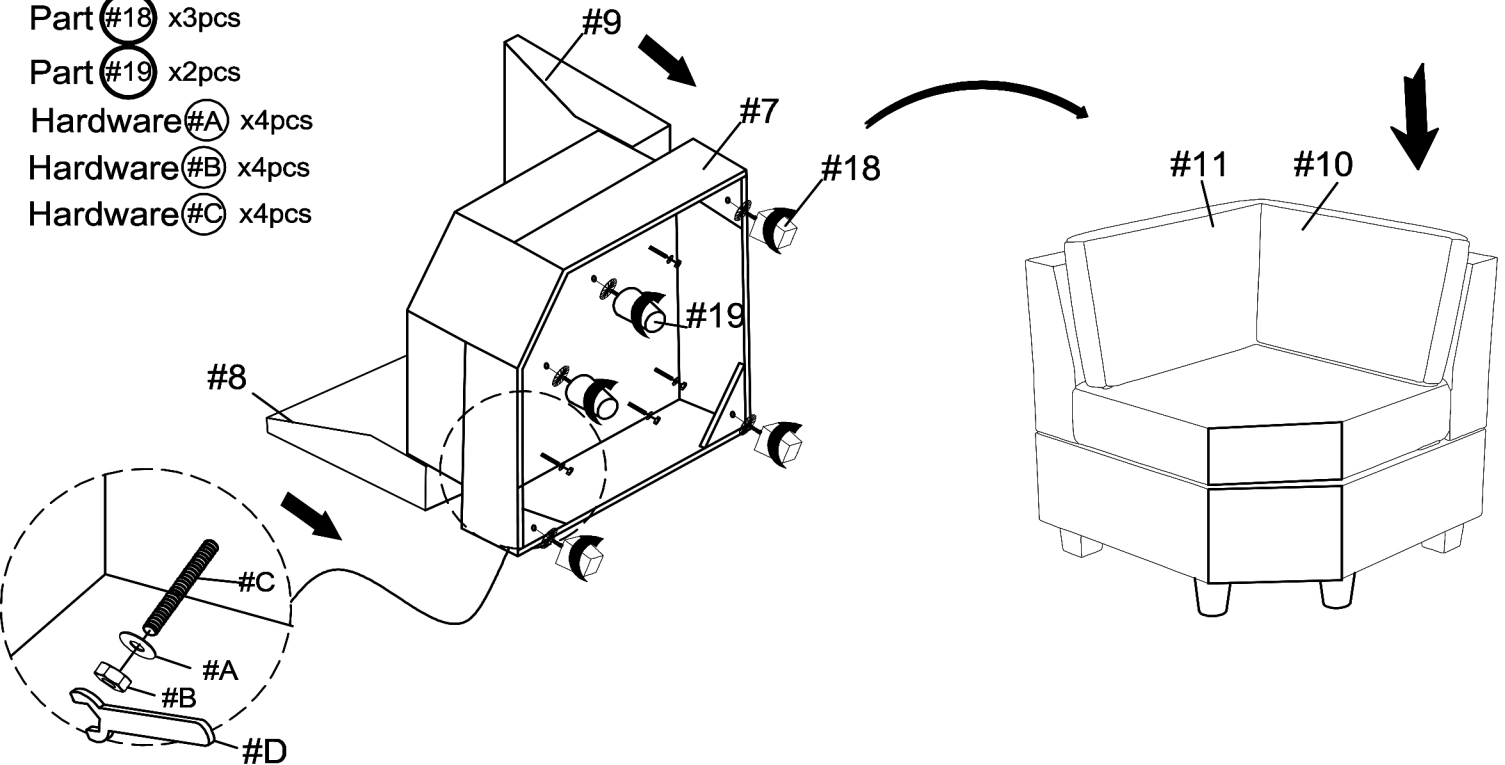

ASSEMBLY INSTRUCTIONS

7

Twist the Threaded bolt (#C) onto the Right Sofa Back Rest (#13).

Part #13 x1pc
Hardware #C x2pcs

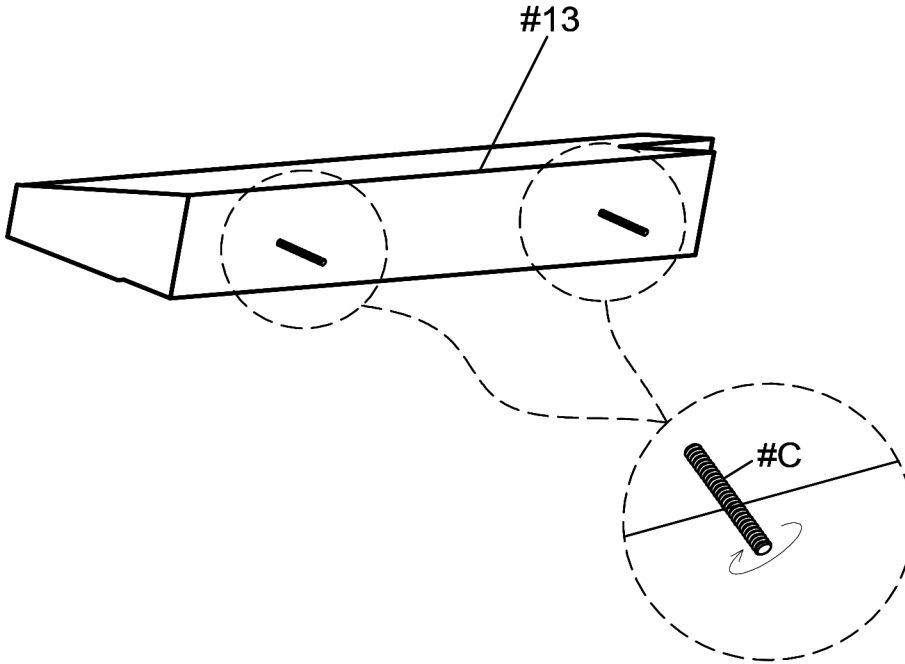

8

Insert the Right Sofa Back Rest (#13) into the Right Sofa Seat (#12). Secure by using Flat washer (#A) with Nut (#B). Attach the Plastic Leg (#18) to the Right Sofa Seat (#12). Lift upright and place the Right Sofa Back Cushion (#14).

Part #12 x1pc
Part #18 x4pcs
Hardware #A x2pcs
Hardware #B x2pcs
Hardware #C x2pcs

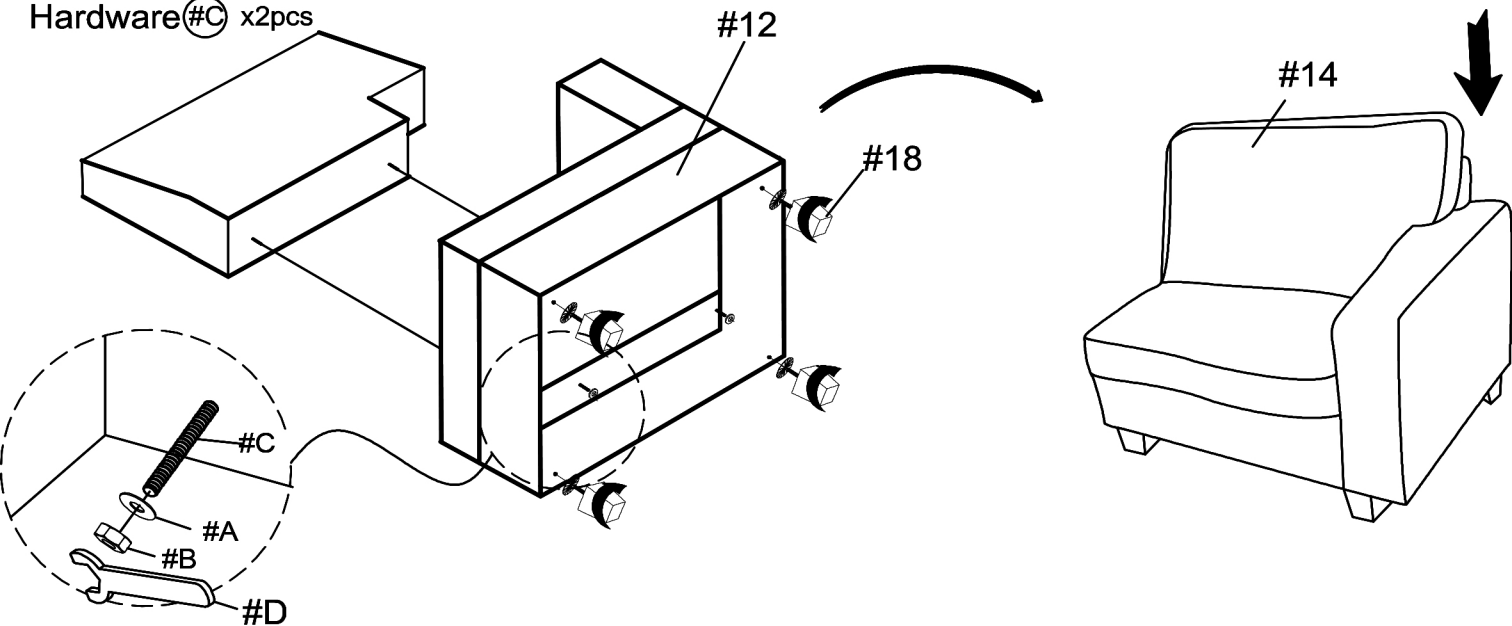

ASSEMBLY INSTRUCTIONS

9

Part #17 x1pc

Part #18 x4pcs

Attach the Plastic Leg (#18) to the Ottomon (#17). Lift upright.

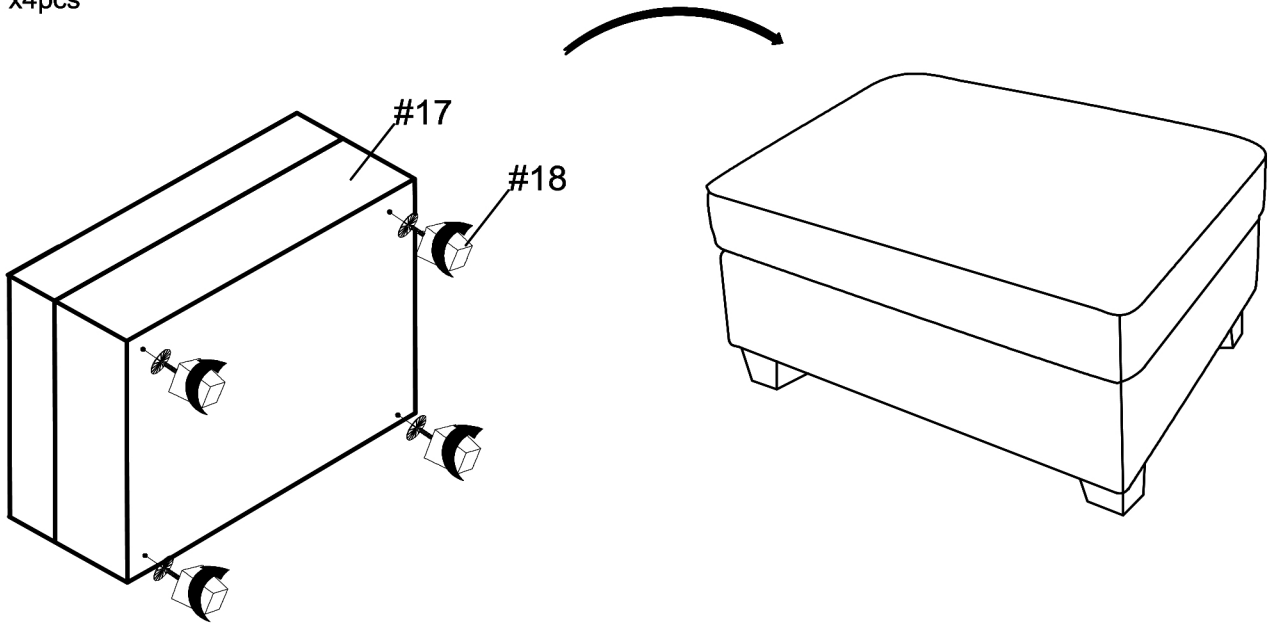

10

Align and lock the parts by inserting the long connecting tab into the shorter end.

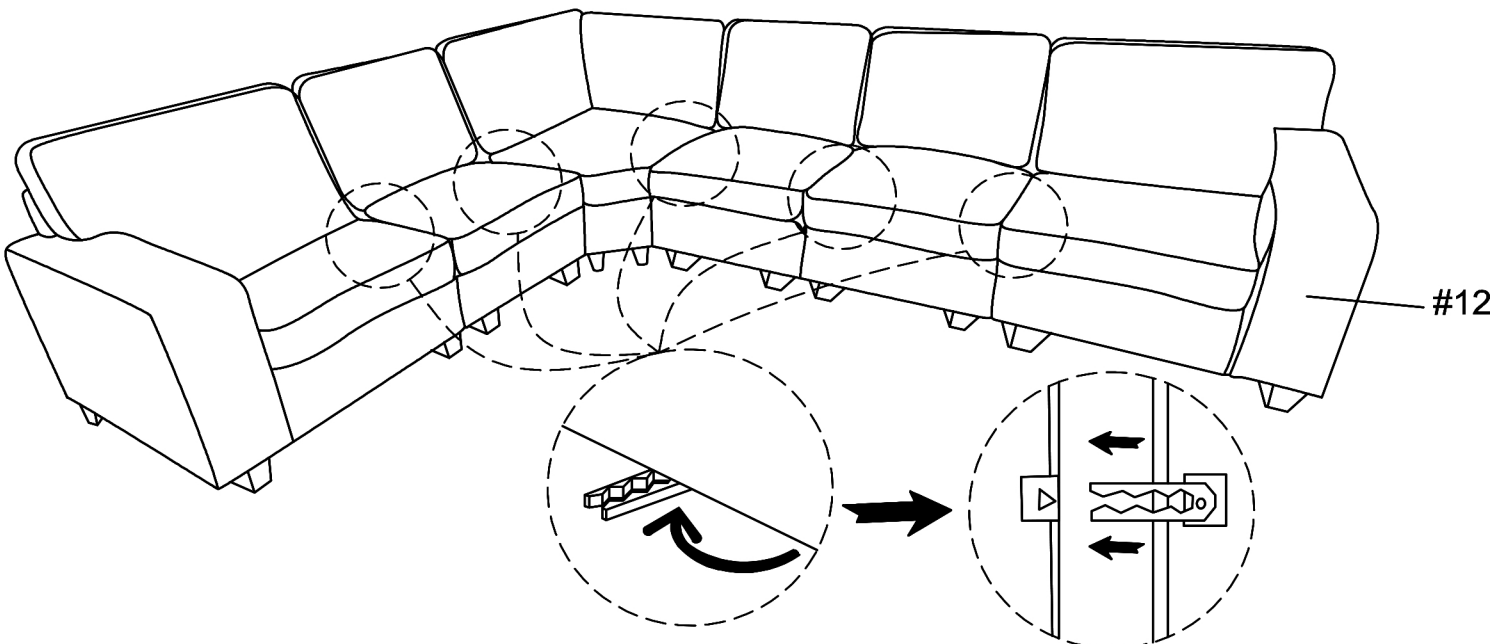

ASSEMBLY INSTRUCTIONS

11

Part #15 x 3pcs

Part #16 x 3pcs

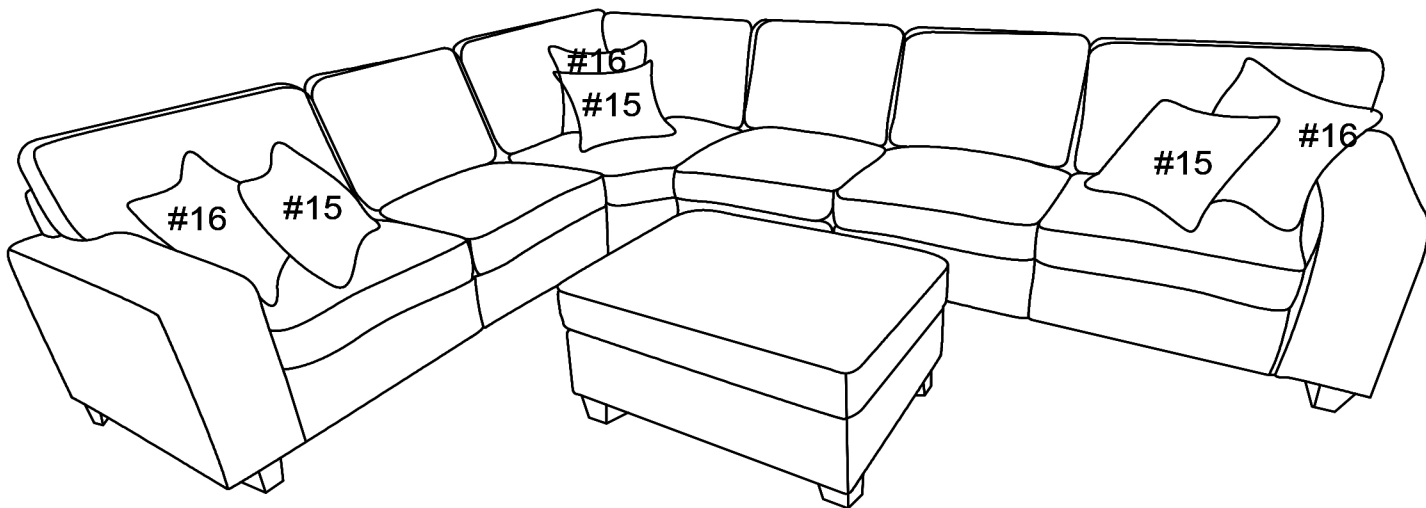

ASSEMBLY COMPLETED



Please ensure the furniture rests on an even and flat surface. If the product wobbles or feels loose, double-check all bolts and/or screws are properly tightened and secured.



Keep this handy!

Please retain this instruction manual and any order-related information for future reference.



Lift, don't drag!

To avoid damage to product please always LIFT the product when transporting or adjusting the placement.