

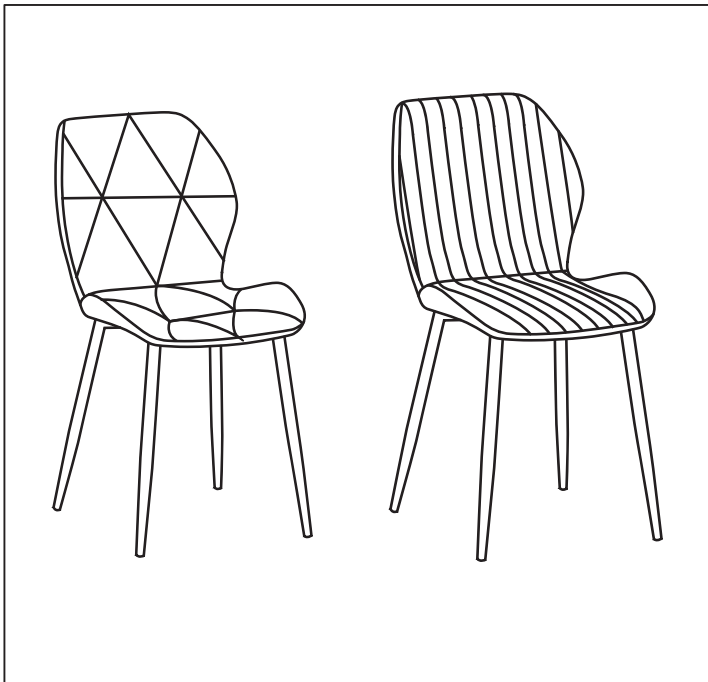













# Installation & Assembly



Ax1 	Bx1 	Cx1 	Dx1 
Ex4  6x13mm	Fx4  6x45mm	Gx8 	Hx4 
Ix1 			

SPARE (Ersatzteile)

Ex1  6x13mm	Fx1  6x45mm	Gx1 	Hx1 	
--	---	--	--	--

## STEP1

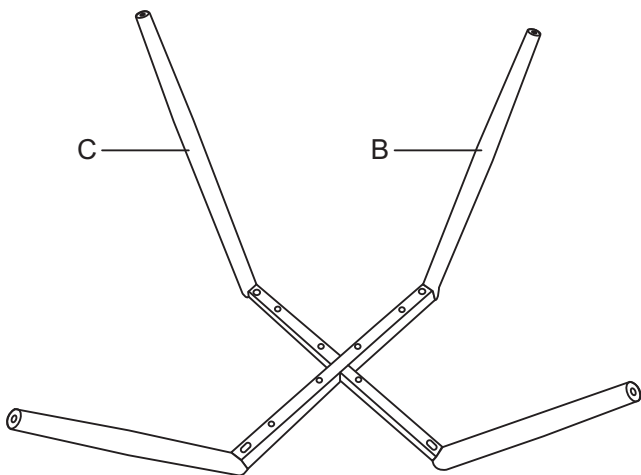

## STEP2

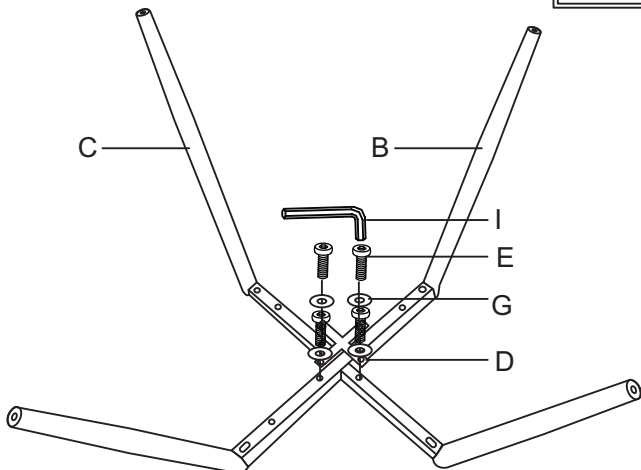

## STEP3

