

Reminders

1. Two people are needed for assembly.
2. Use only the hardware supplied.
3. Do not over-tighten bolts.
4. This item may require periodic tightening.

ASSEMBLY INSTRUCTIONS

IMPORTANT NOTE:

Please keep all hardware parts out of the reach of children.

STEP 1

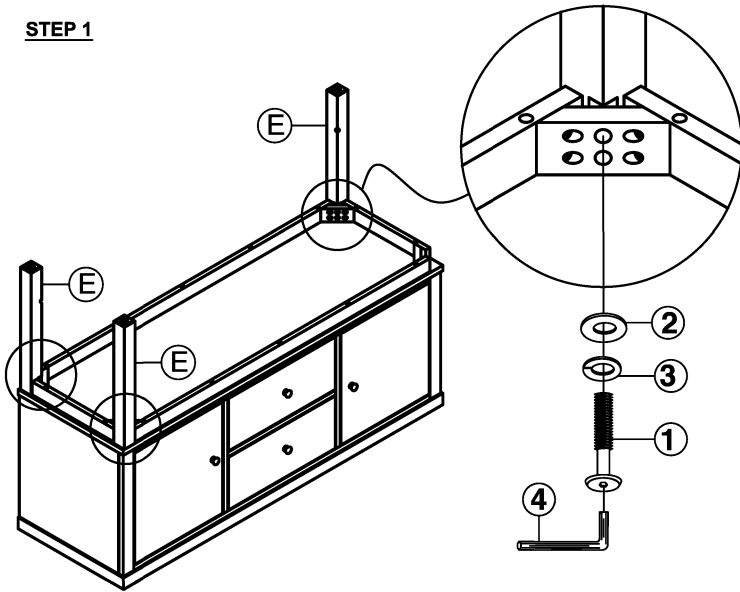

STEP 2

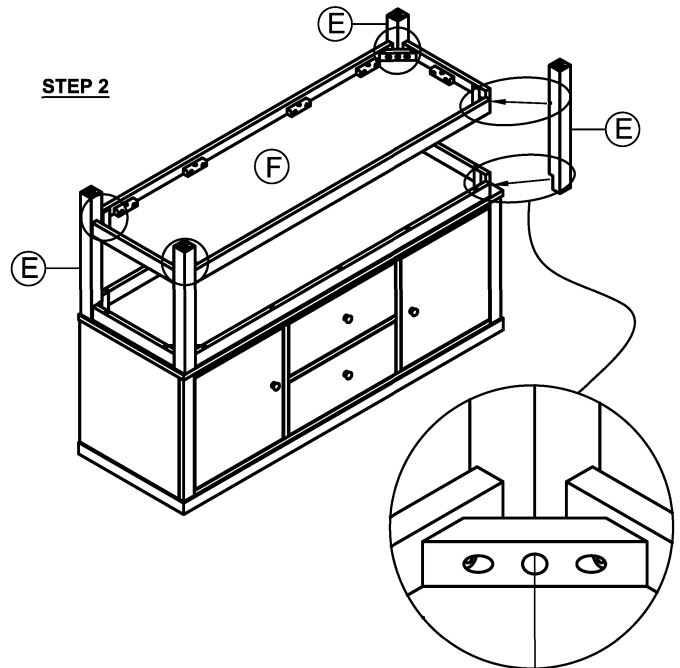

STEP 5

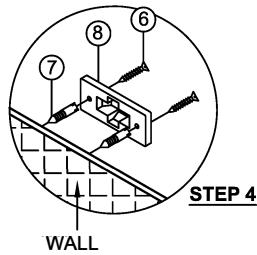
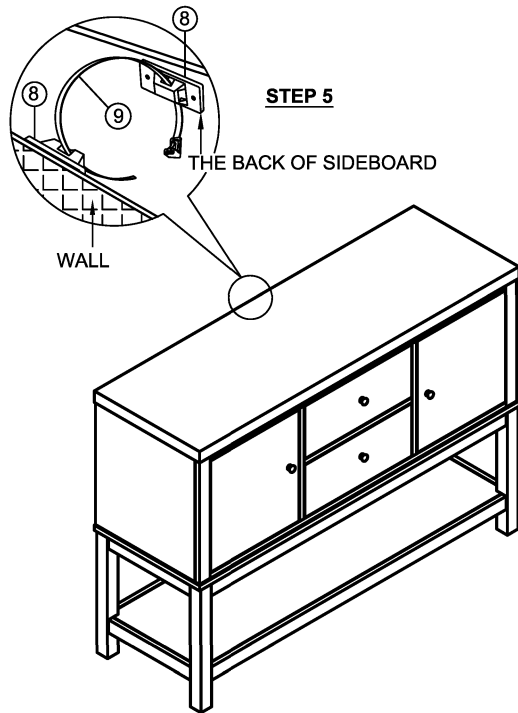

STEP 4

WALL

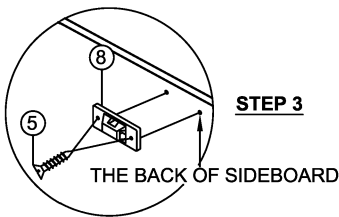

STEP 3

THE BACK OF SIDEBOARD

TO INSTALL THE SAFETY WALL STRAP

Thank you for purchasing this quality product. Be sure to check all packing material carefully for small parts that may have come loose inside the carton during shipment.

1 OF 2

① Bolt

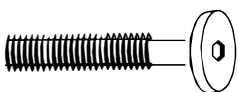

12 PCS

② Flat Washer



12 PCS

③ Lock Washer



12 PCS

④ Allen Key



1 PC

⑤ Screw
($\phi 7^* \phi 3.5^* 16$)

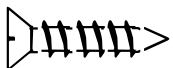

2 PCS

⑥ Screw
($\phi 7^* \phi 3.5^* 25$)

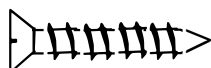

2 PCS

⑦ Wall Mounts



2 PCS

⑧ Mounting Plates

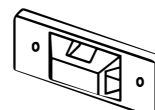





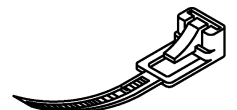



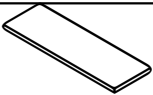

2 PCS

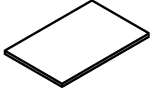
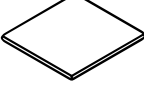
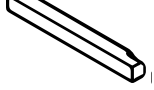
⑨ Secure Band

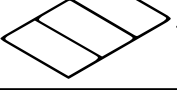

1 PC

Components List

PART NO	FIGURE	DESCRIPTION	QTY
A		Sideboard Top	1pc
B		Drawer	2pcs
C		Door Frame	2pcs
D		Wood Shelf	2pcs
E		Leg	4pcs
F		Bottom Shelf	1pc
G		Back panel	3pcs
H		Handle	4pcs
I		Bolt	4pcs
J		Shelf Clips	8pcs
K		Plastic Glide	4pcs
L		Side Door Hinge	4pcs

