

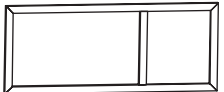

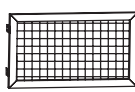







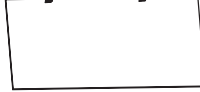
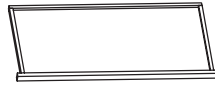



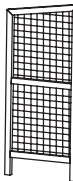





Ax2 	Bx2 	Cx2 	Dx1 	Ex2 	Fx1 
Gx2 	Hx4 	Ix1 	Jx1 	Kx1 	Lx1 
Mx4 	Nx4  M3x $\frac{10}{0.4}$	Ox16  M3x $\frac{12}{0.5}$	Px10  M3x $\frac{20}{0.8}$	Qx12  M3x $\frac{25}{1.0}$	Rx8  M3x $\frac{30}{1.2}$
Sx8  M3x $\frac{35}{1.4}$	Tx4 	Ux4 		 mm inch x1	



3 x2

Ox16  M3x $\frac{12}{0.5}$

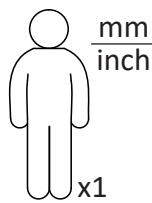
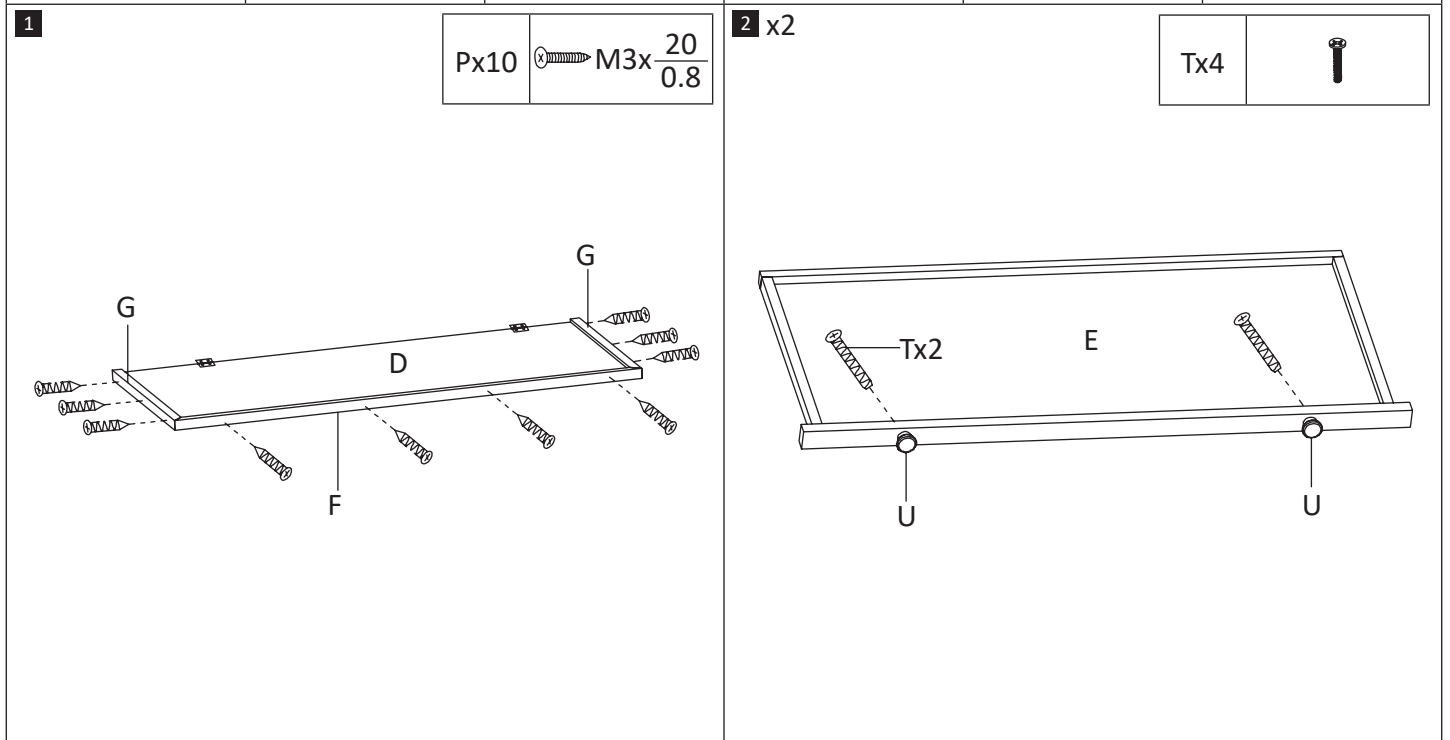
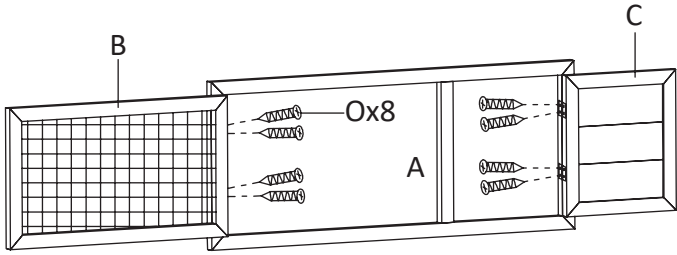

4

Rx8  M3x $\frac{30}{1.2}$

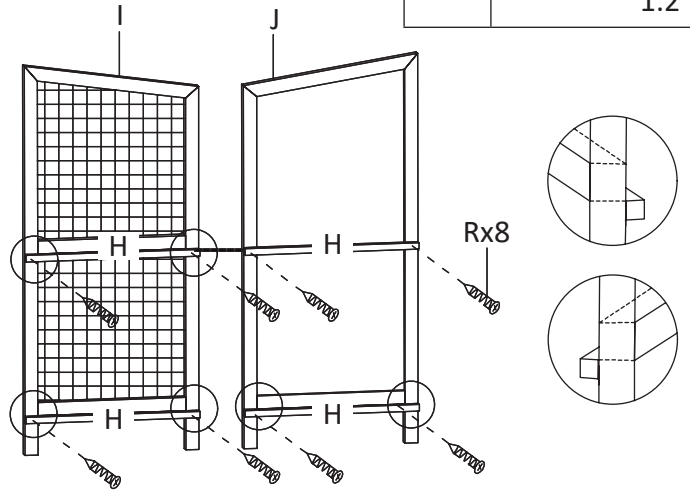

5

Qx8  M3x $\frac{25}{1.0}$

Sx8  M3x $\frac{35}{1.4}$

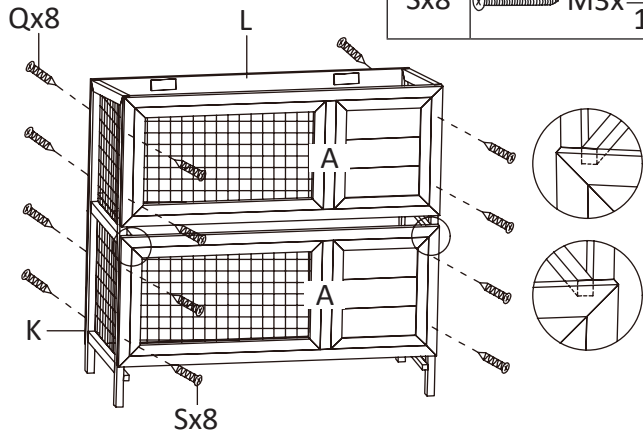

6

Qx4  M3x $\frac{25}{1.0}$

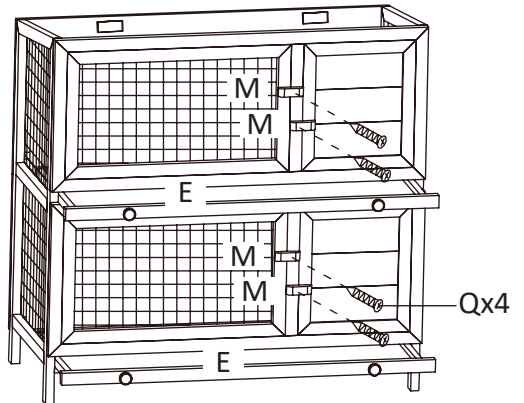

7

Nx4  M3x $\frac{10}{0.4}$

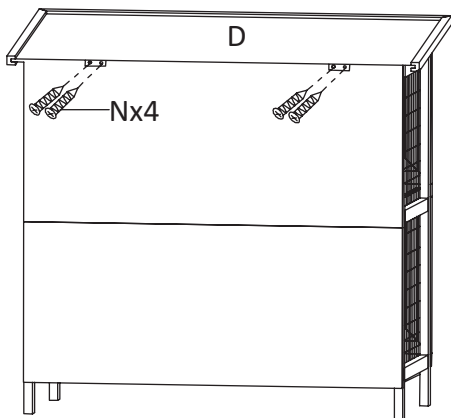

8

