

A

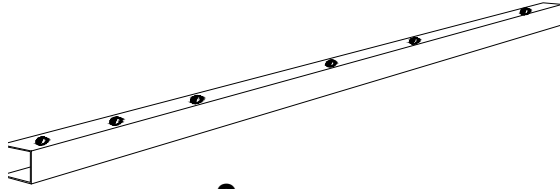

3x

B

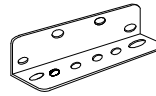

2x

C

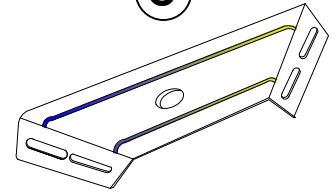

4x

D

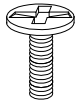

6MAx15

20x

E

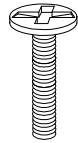

6MAx30

30x

F



8x

G

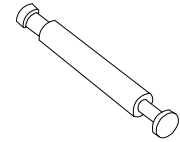

4x

H

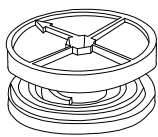

8x

I

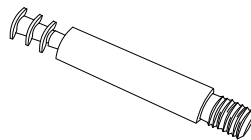

8x

L

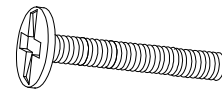

6MAx45

4x

M



∅ 8x30

8x

N

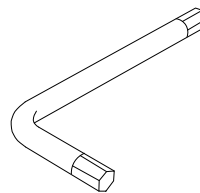

1x

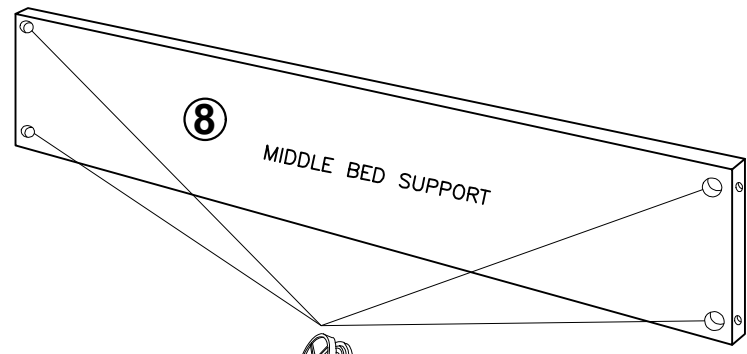
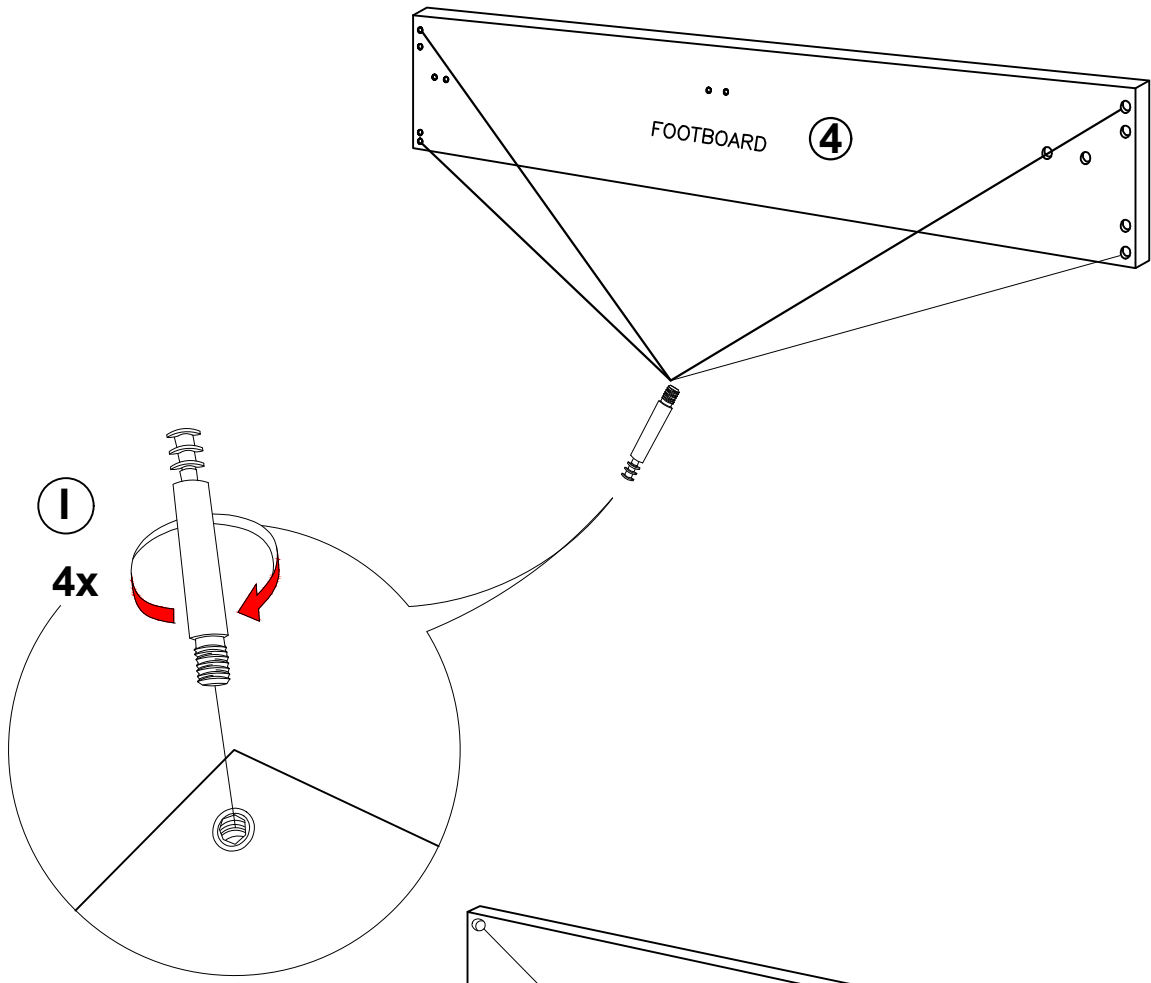

"ARROW " SYMBOL HAS TO BE FIXED ON THE INNER HOLE SIDE

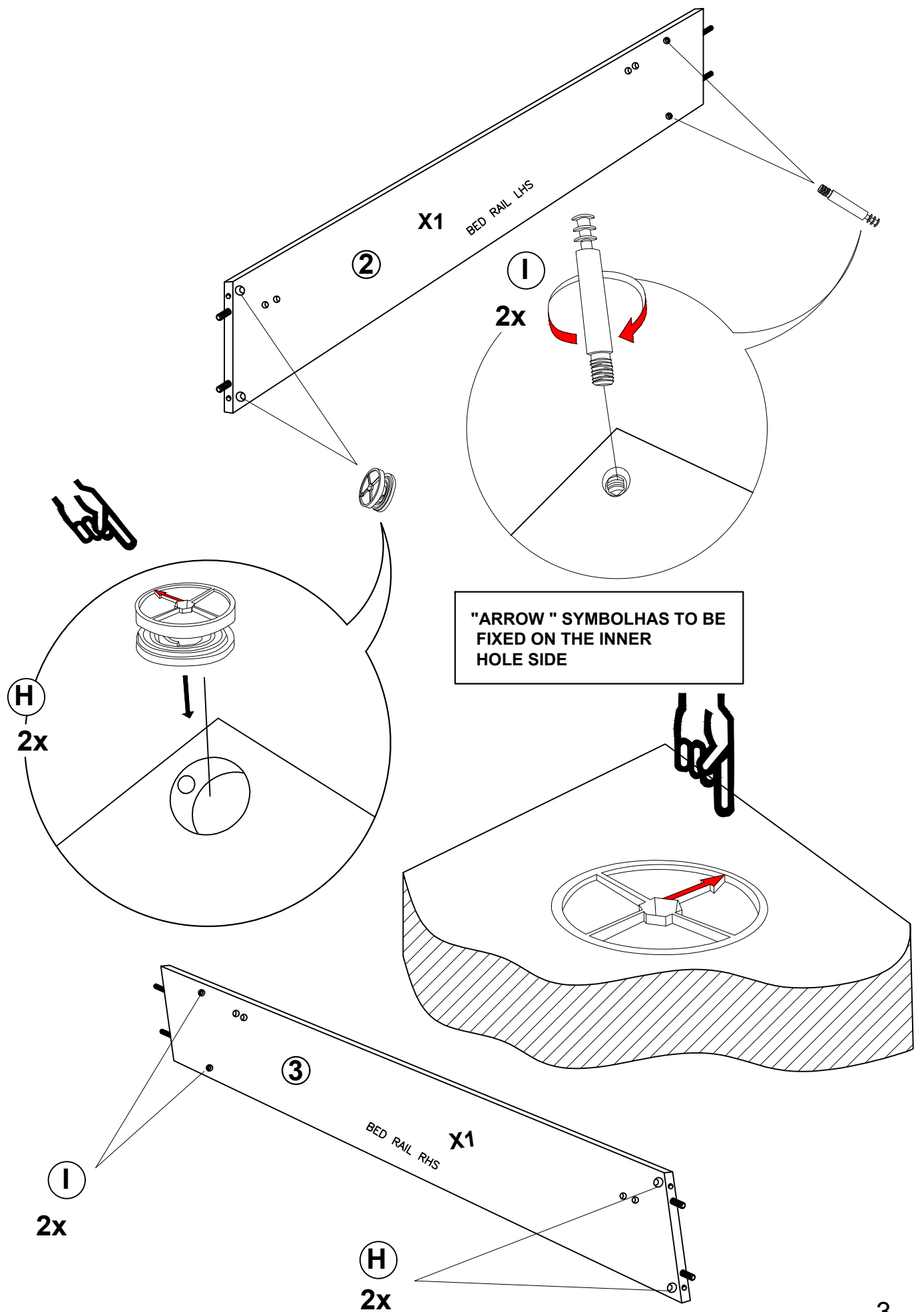

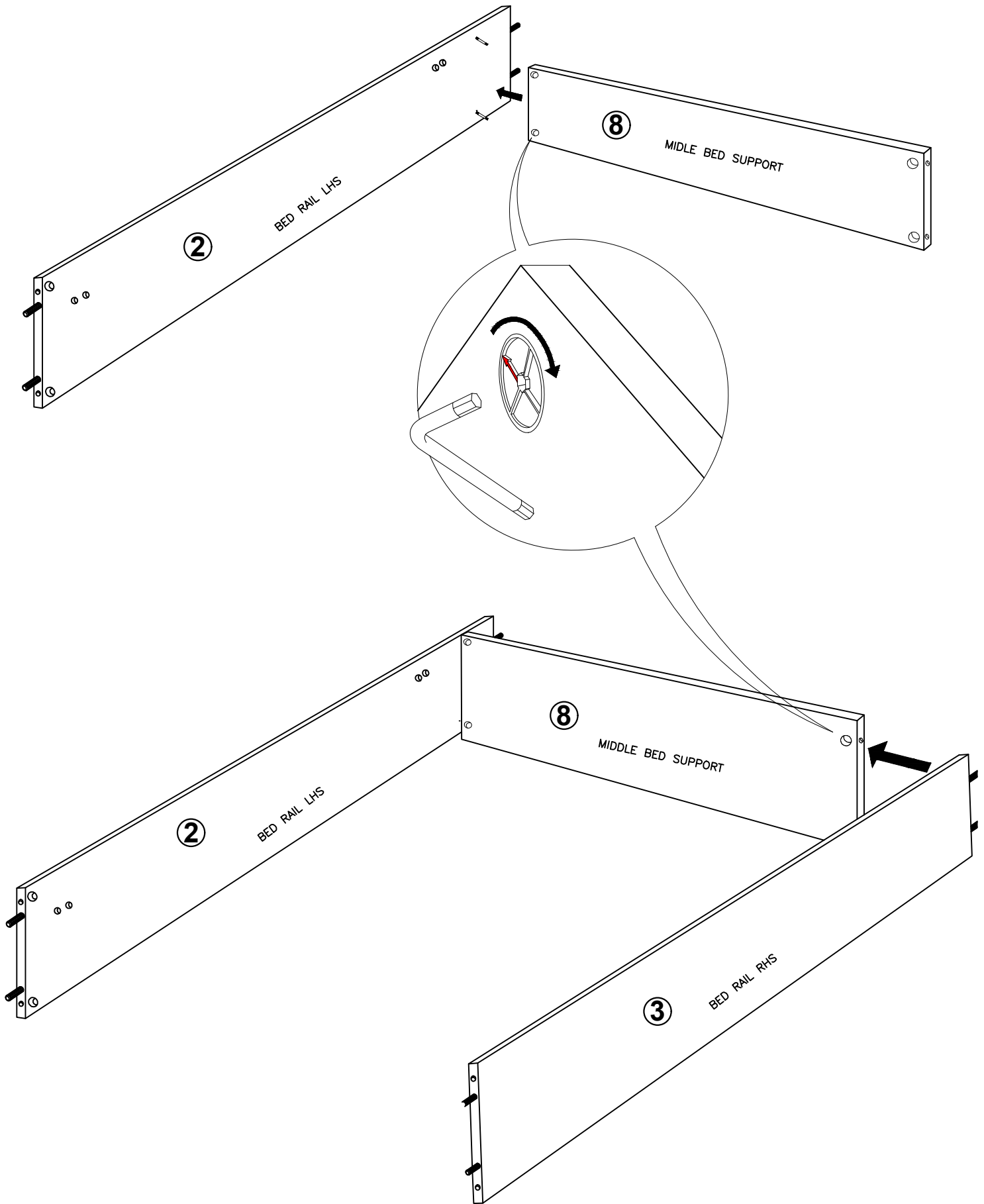

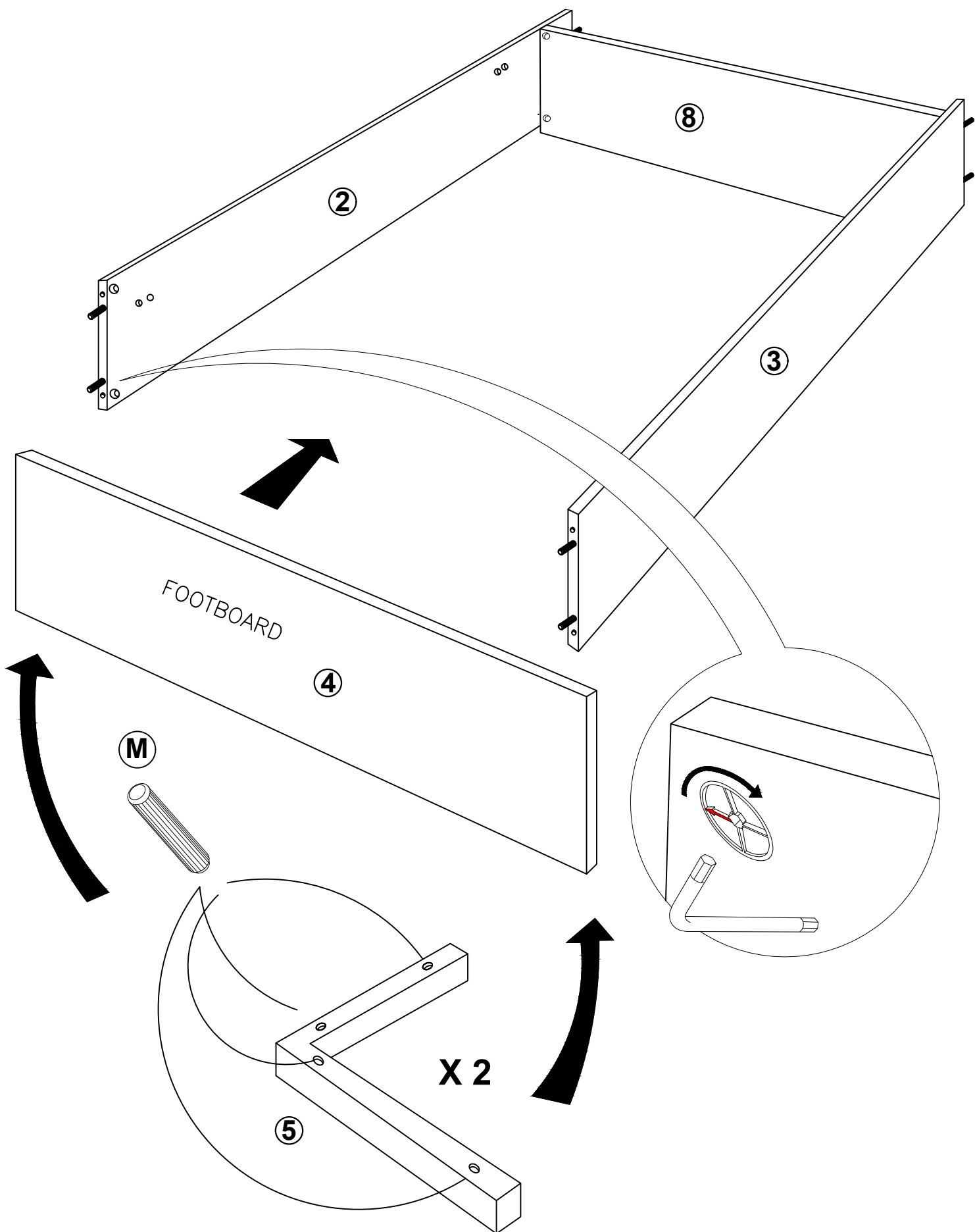

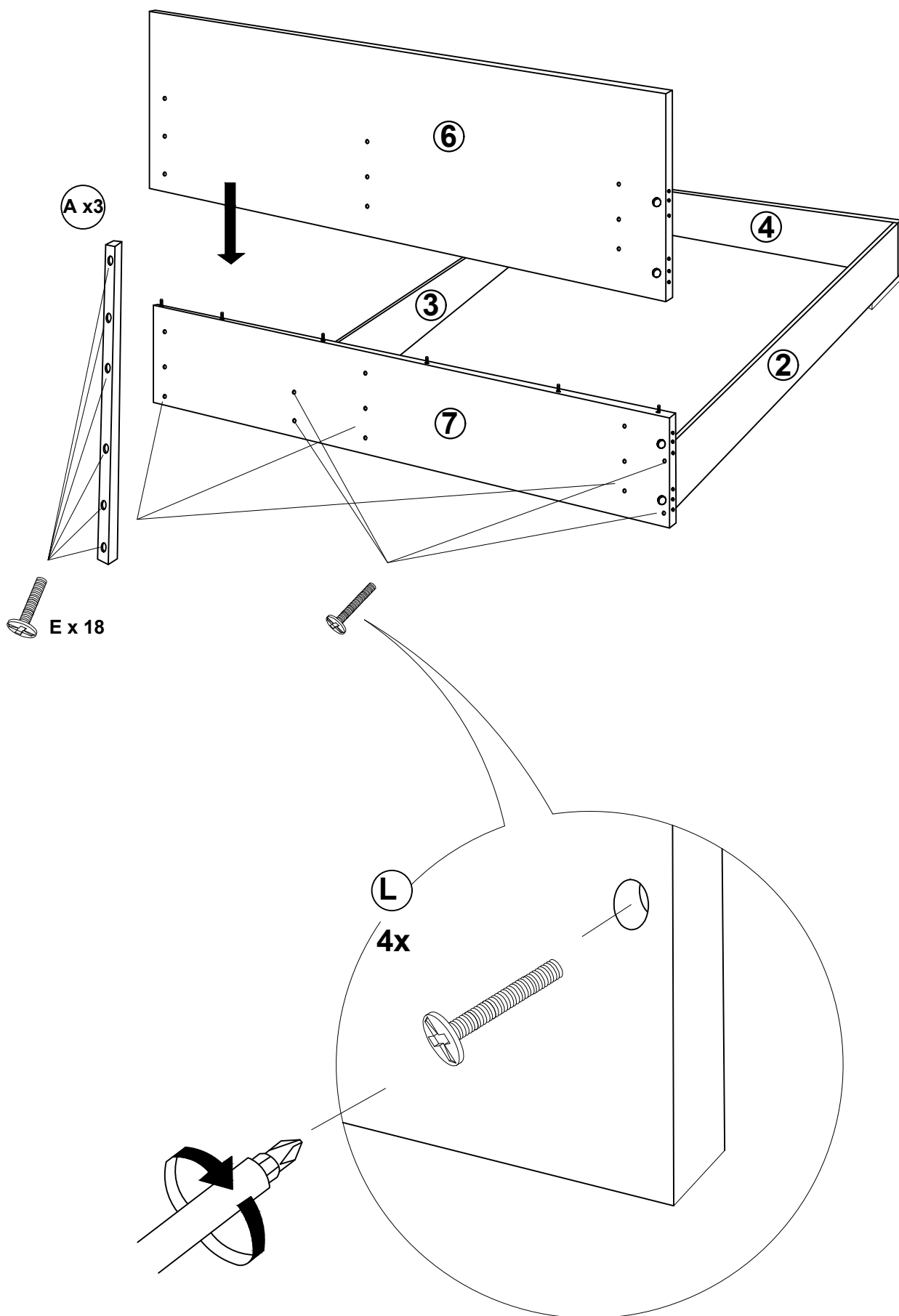

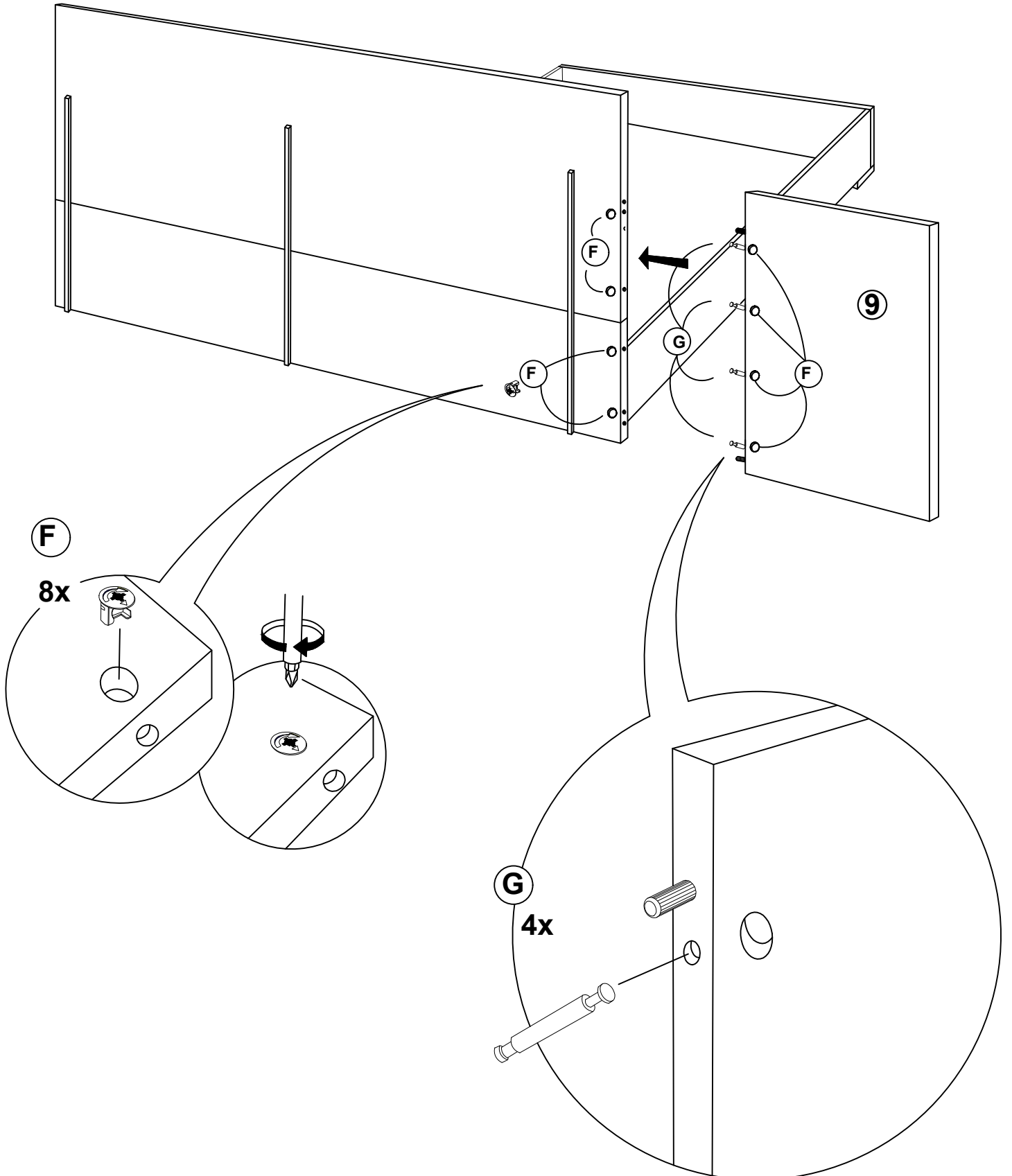

UPHOLSTERED HEADBOARD

