

*Thank you for your purchase!*

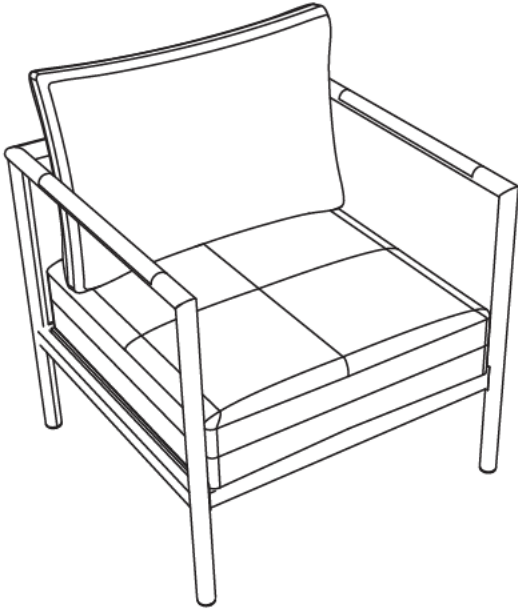

## **ASSEMBLY INSTRUCTIONS**

### **Before You Begin:**

Please identify all component parts and hardware pieces required before your begin. Carefully remove all of the components from the packaging and set aside for assembly. Assemble on a soft surface to prevent scratching during assembly.

### **Caution:**

Tighten all components securely before use. Failure to do so may result in personal injury. DO NOT use any sharp objects to open plastic wrapped components as damage to product or components may result.



### **Warning:**













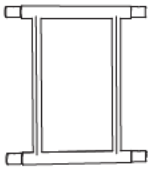

- CHOCKING HAZARD -Small Parts. Adult Assembly Required.
- DO NOT ALLOW CHILDREN TO CLIMB ON FURNITURE

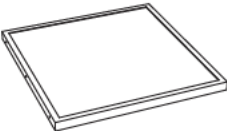
Serious or fatal crushing injuries can occur from furniture tipping over. You must install the Tipping Restraint Hardware with the unit to prevent the unit from tipping and causing any accidental injury,instability,death or damage. The tipping restraint is intended only as a safety measure, it is not a substitute for proper adult supervision.

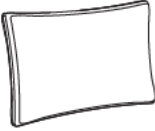
To help prevent furniture from tipping over it must be permanently attached to the wall. Anti-Tip Safety Wall Straps suitable the unit weight and wall materials (if not included) should be purchased and installed.

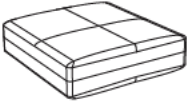











# PARTS

Part	Drawing	Description	QTY	Part	Drawing	Description	QTY
A		Left Armrest	1x	H		M6x70 Screw	6x
B		Right Armrest	1x	I		Washer Ring	10x
C		Back	1x	J		Nut	10x
D		Seat	1x	K		Cap A	10x
E		Back Cushion	1x	L		Allen Key	1x
F		Seat Cushion	1x	M		Wrench	1x
G		M6x40 Screw	4x	N		Cap B	10x

# STEPS

## STEP 1 REQUIRED PARTS

Part	Drawing	Description	QTY
A		Left Armrest	1x
B		Right Armrest	1x
C		Back Part	1x
G		M6x40 Screw	4x
I		Washer Ring	4x
J		Nut	4x
K		Cap A	4x
L		Allen Key	1x
M		Wrench	1x
N		Cap B	4x





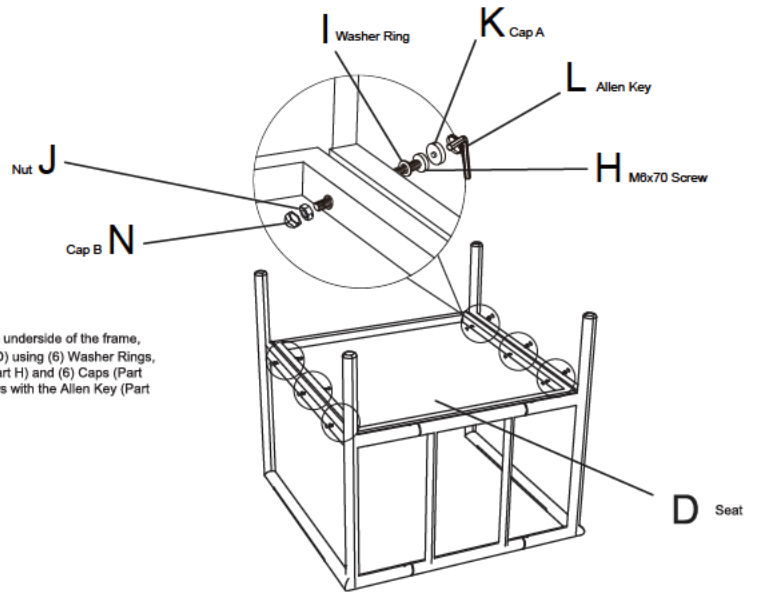
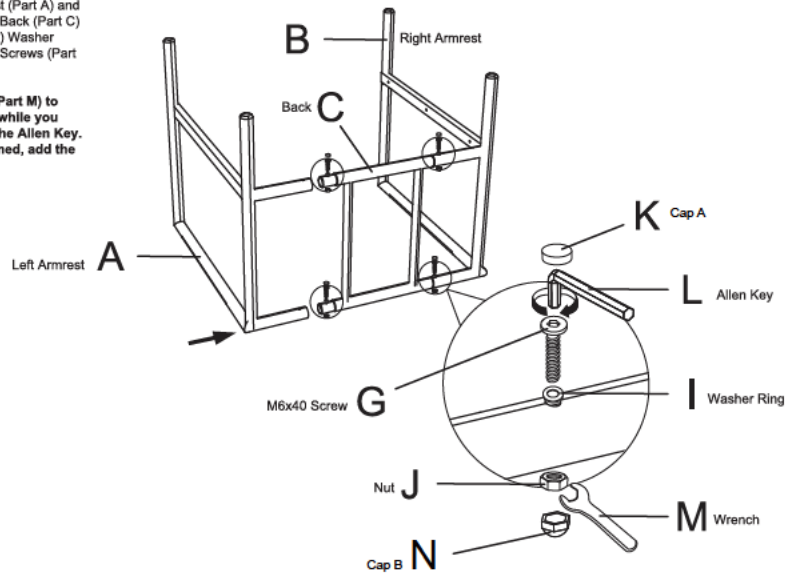

**STEP 1:** From the underside of the frame, attach Left Armrest (Part A) and Right Armrest (Part B) to Back (Part C) using (4) Nuts (Part J), (4) Washer Rings (Part I), (4) M6x40 Screws (Part G) and (4) Caps (Part K).

**Note:** Use the Wrench (Part M) to hold the nut stationary while you tighten the screw with the Allen Key. Once completely tightened, add the Caps (Part K).



**STEP 2:** From the underside of the frame, attach the seat (Part D) using (6) Washer Rings, (6) M6x70 Screws (Part H) and (6) Caps (Part K). Tighten the screws with the Allen Key (Part L) then install Caps.

## STEP 2 REQUIRED PARTS

Part	Drawing	Description	QTY
D		Seat	1x
H		M6x70 Screw	6x
I		Washer Ring	6x
J		Nut	6x
K		Cap A	6x
L		Allen Key	1x
N		Cap B	6x

## STEP 3 PARTS REQUIRED

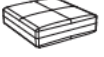
Part	Drawing	Description	QTY
E		Back Cushion	1x
F		Seat Cushion	1x

**STEP 3:** Place Seat Cushion (Part F) and Back Cushion (Part E) onto chair.

