

# 2 DOOR WARDROBE ASSEMBLY INSTRUCTIONS

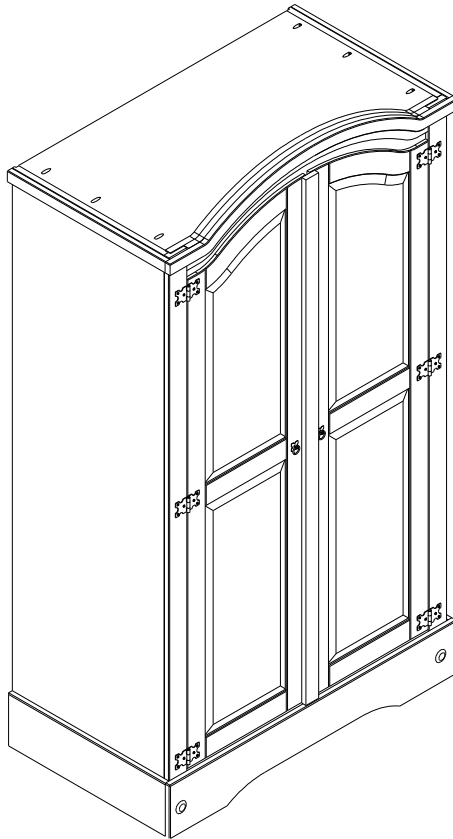

## **IMPORTANT** PLEASE READ BEFORE YOU CONTINUE FURTHER **FOR DOMESTIC USE ONLY** **CARE AND MAINTENANCE**

After unpacking this product please keep the original packaging in case it needs to be returned for any reason.

- Please ensure all fittings and parts are present before commencing with assembly.
- We recommend that you lay a blanket or sheet on the floor to avoid damage to both your floor and the product.
- We strongly recommend that you keep children away from your work area.
- Assemble this product as close to its final position as possible.
- Never drag or push products as this could cause damage to the joints making it inferior.
- Do not place this product next to a radiator or in direct sunlight.
- Wood is a natural product and may expand if subjected to damp and may shrink or crack if subjected to heat. Therefore it is recommended that room temperature is maintained, with no sudden temperature fluctuations.
- Make sure any spillage is wiped off immediately.
- Do not place hot or chilled items directly on to the surface, use a place mat or marking will occur.
- For general cleaning use a duster, and do not use detergents of any kind. However, the surface will need to be retreated from time to time. This can be done by using block wax (unperfumed) and rubbing it over the whole item.
- From time to time it may be necessary to tighten fittings, regular inspections should be carried out.

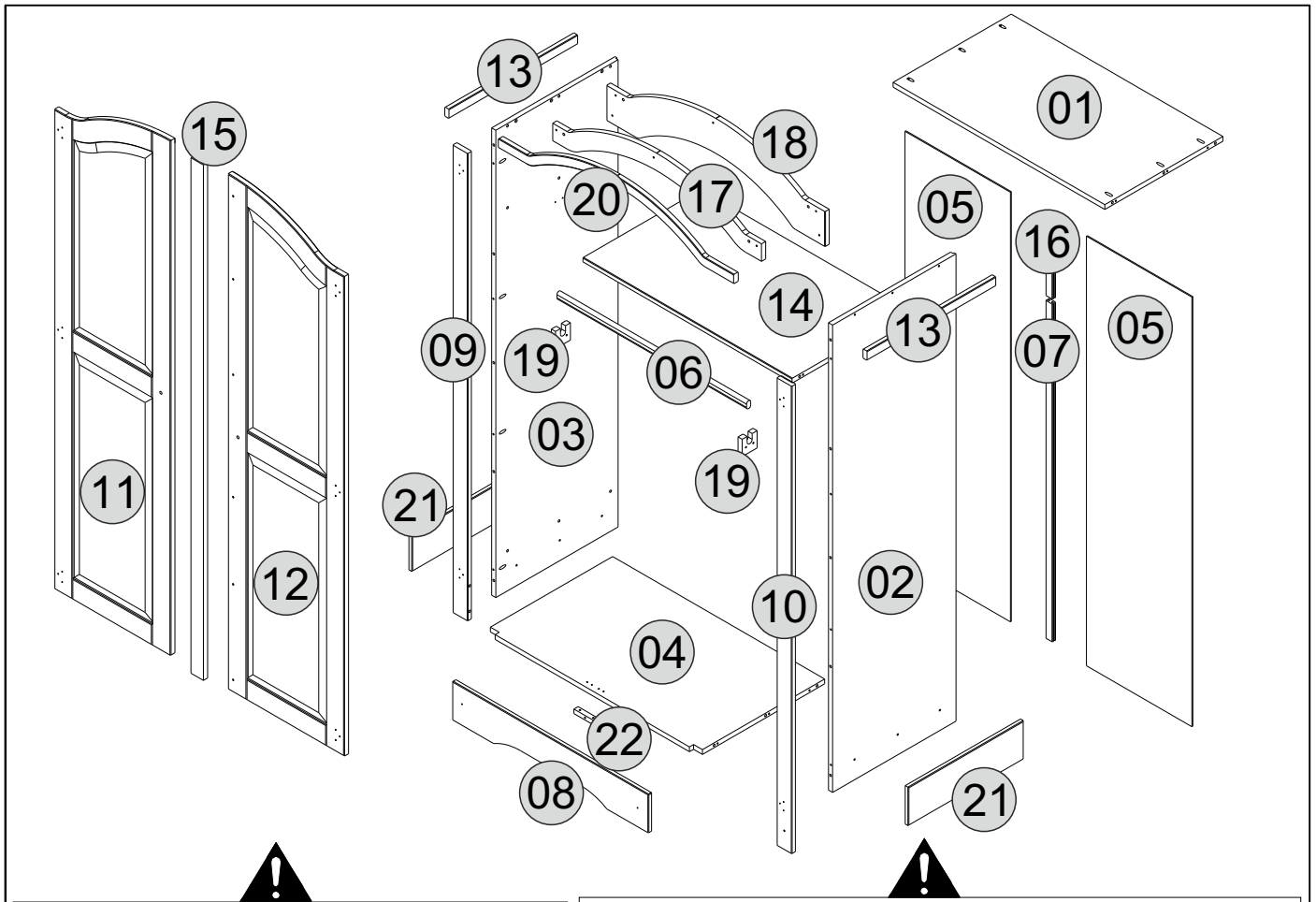











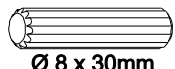
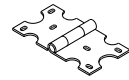

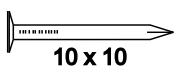
\* Use of power tools to assemble this product will invalidate any claim and damage this product making it unsafe !!!  
 \* Please assemble on a clean soft surface to avoid damage.

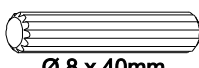
\* Please check contents and read the instructions before commencing assembly.  
 \* Assemble this product following the enclosed instructions carefully.  
 \* Please take care to avoid damaging panels during assembly.

Part Number	Part Code	Part Description	Quantity	Carton
01		Top Panel (Small)	1	2/2
02		Right Side Panel	1	1/2
03		Left Side Panel	1	1/2
04		Base	1	2/2
05		Back Panel	2	1/2
06		Hanging Rail	1	2/2
07		Bottom Back Panel Strip	1	1/2
08		Front Plinth	1	2/2
09		Left Front Upright	1	1/2
10		Right Front Upright	1	1/2
11		Left Door	1	1/2
12		Right Door	1	1/2
13		Top Side Plinth	2	2/2
14		Fixed Shelf	1	2/2
15		Door Strip	1	1/2
16		Upper Back Panel Strip	1	1/2
17		Top Middle Plinth	1	2/2
18		Top Back Plinth	1	2/2
19		Hanger Support	2	2/2
20		Top Front Plinth	1	2/2
21		Side Plinth	2	2/2
22		Support Block	1	2/2

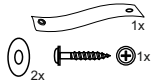
## FITTINGS

A	 Ø 4,5 x 30mm	29	I		02
B	 Ø 8 x 30mm	28	J		06
C	 Ø 3,5 x 30mm	18	K	 Ø 4,5 x 25mm	06
D	 10 x 10	30	L	 Ø 4,0 x 45mm	03
E	 Ø 3,5 x 16mm	52	M	 Ø 8 x 40mm	02
F		04	N		02
G		04	O	 1x 2x	01
H	 Ø 4,0 x 20mm	06			

## TOOLS REQUIRED

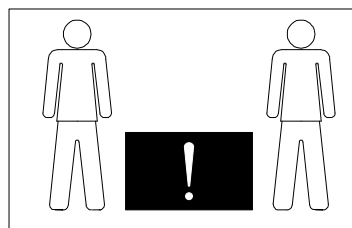
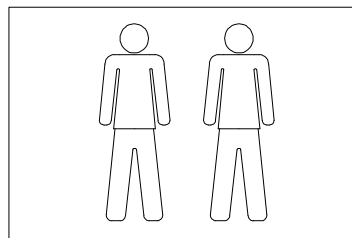
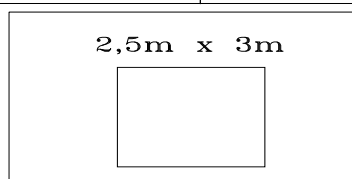
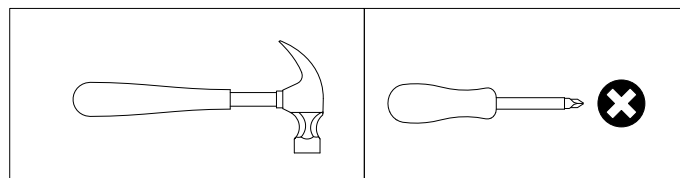

# STEP 1

## PARTS REQUIRED

01 - TOP PANEL (SMALL) x1

14 - FIXED SHELF x1

## HARDWARE REQUIRED

B  12  
Ø 8 x 30mm

## TOOLS REQUIRED

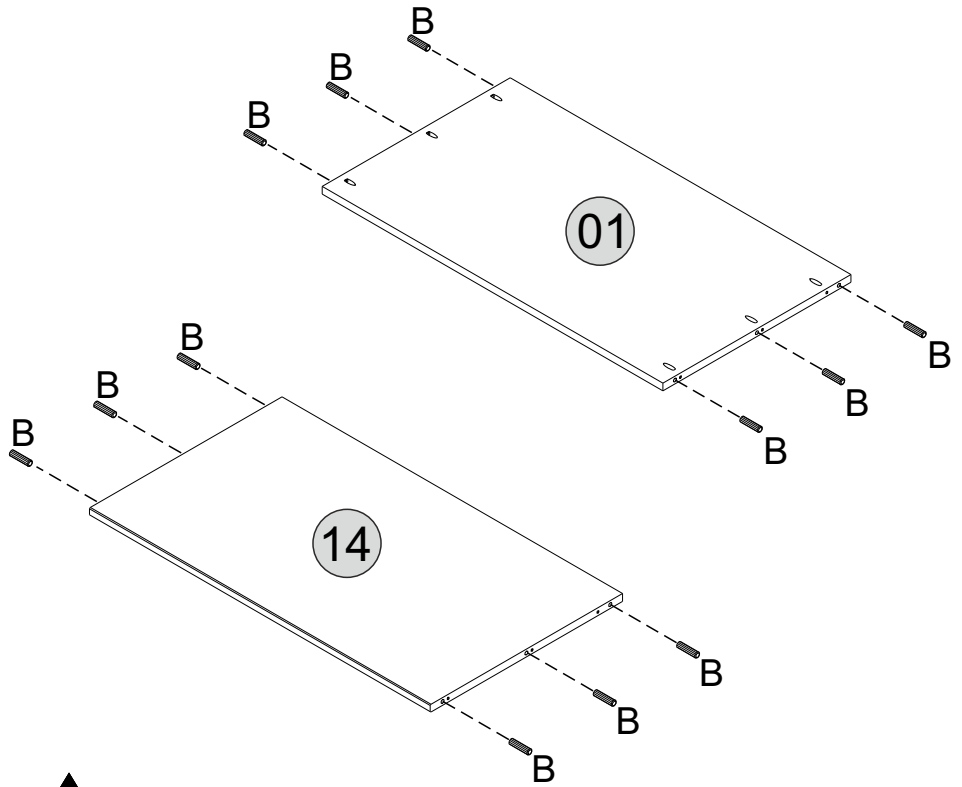

 Please assemble on a clean soft surface to avoid damage.

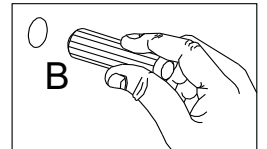

# STEP 2

## PARTS REQUIRED

04 - TOP PANEL (SMALL) x1

20 - TOP FRONT PLINTH x1

22 - SUPPORT BLOCK x1

## HARDWARE REQUIRED

B  06  
Ø 8 x 30mm

C  02  
Ø 3,5 x 30mm

M  02  
Ø 8 x 40mm

## TOOLS REQUIRED

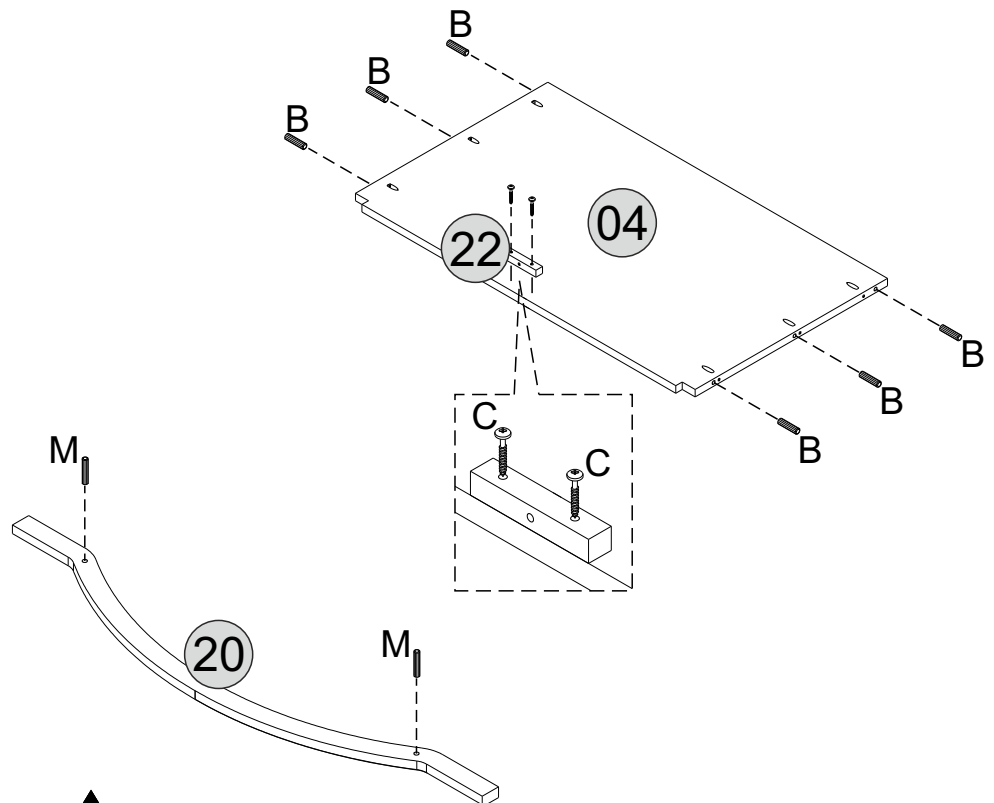
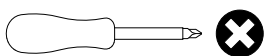

 Please assemble on a clean soft surface to avoid damage.

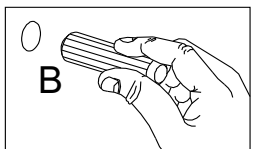



# STEP 3

## PARTS REQUIRED

02 - RIGHT SIDE PANEL	x1
03 - LEFT SIDE PANEL	x1
19 - HANGER SUPPORT	x2

## HARDWARE REQUIRED

B		10
C		04

## TOOLS REQUIRED

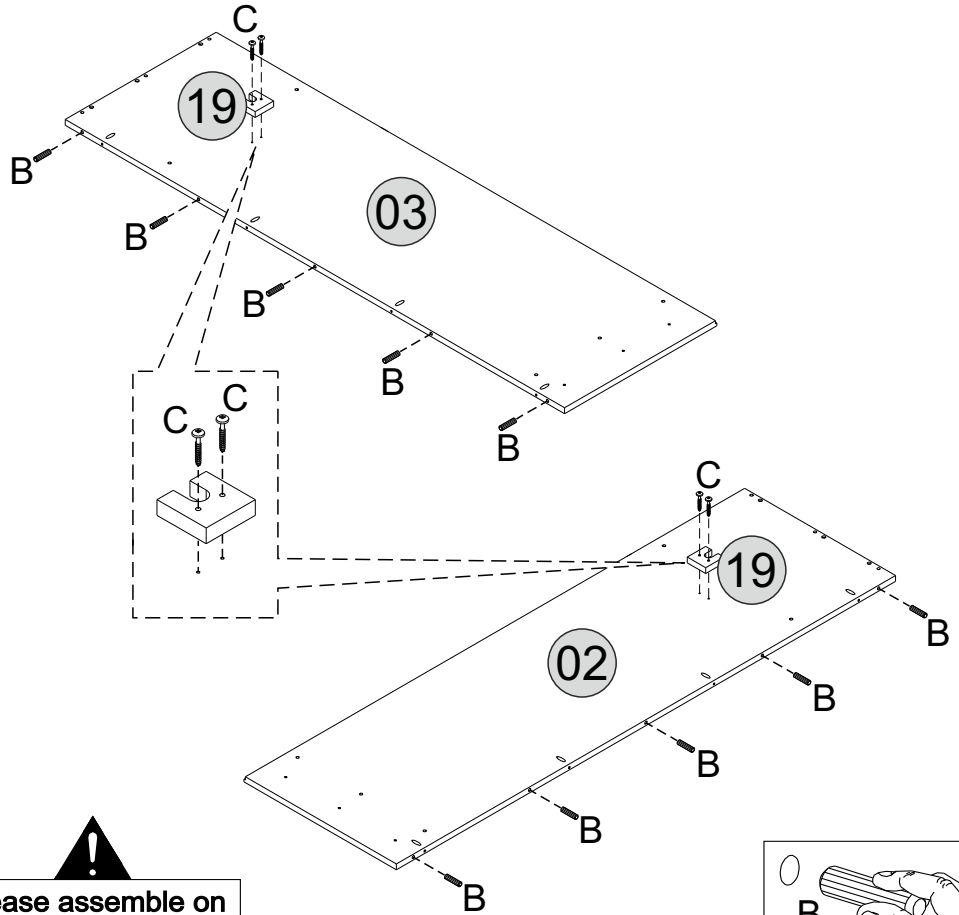
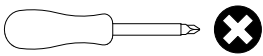

 Please assemble on a clean soft surface to avoid damage.

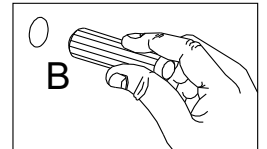

# STEP 4

## PARTS REQUIRED

02 - RIGHT SIDE PANEL	x1
10 - RIGHT FRONT UPRIGHT	x1

## HARDWARE REQUIRED

C		04
---	---	----

## TOOLS REQUIRED

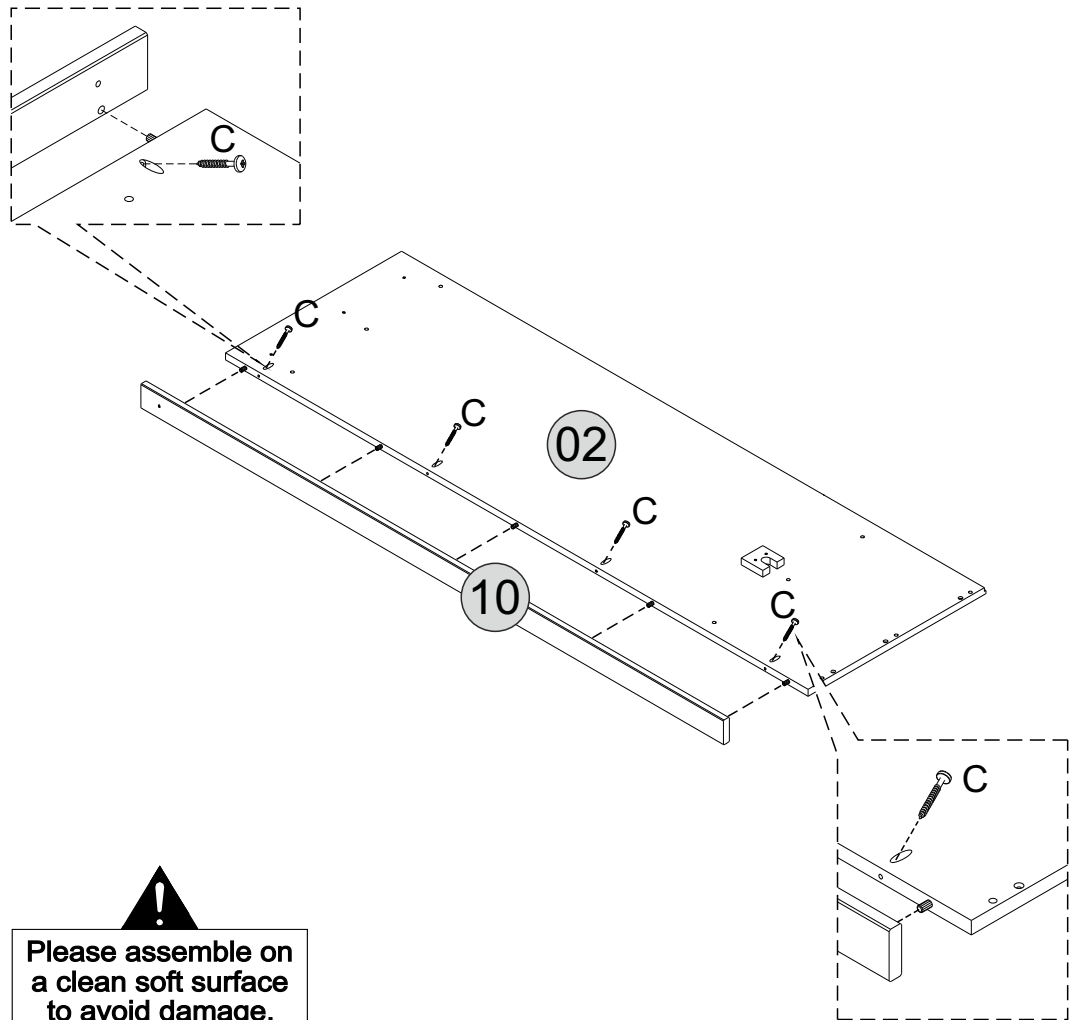
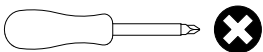

 Please assemble on a clean soft surface to avoid damage.

# STEP 5

## PARTS REQUIRED

13 - TOP SIDE PLINTH x1

21 - SIDE PLINTH x1

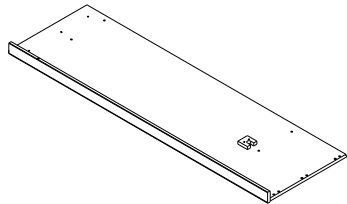

## HARDWARE REQUIRED

A  03  
Ø 4,5 x 30mm

K  03  
Ø 4,6 x 25mm

## TOOLS REQUIRED

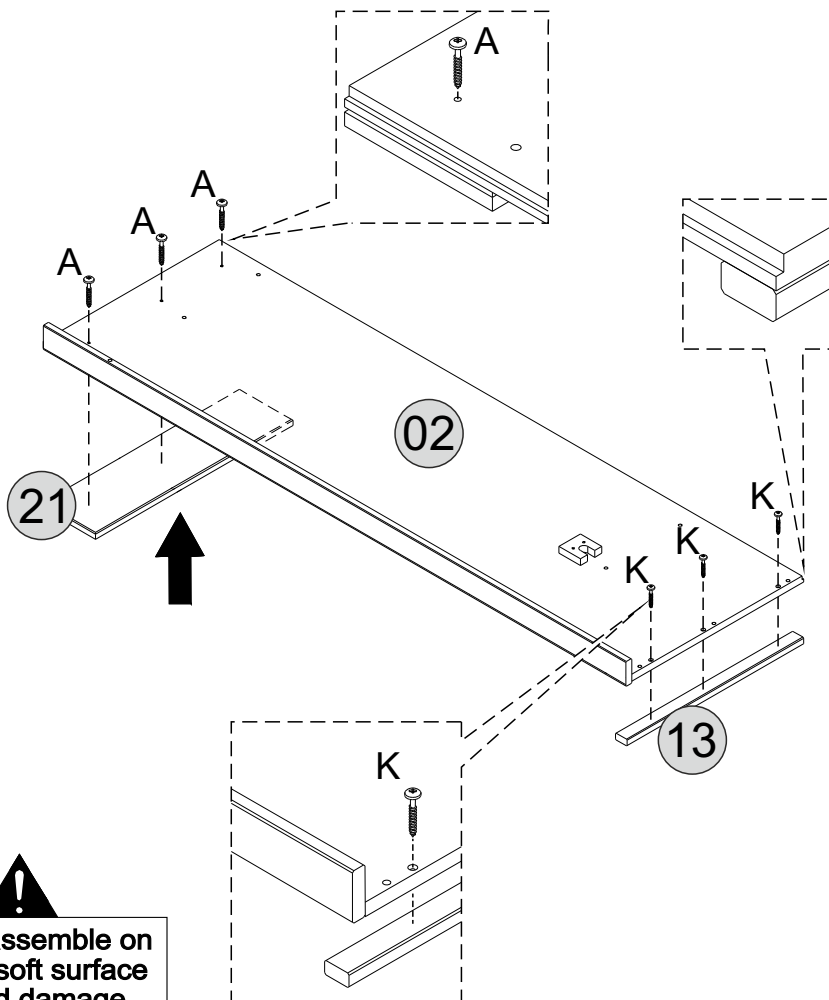
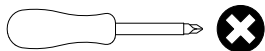

 Please assemble on a clean soft surface to avoid damage.

# STEP 6

## PARTS REQUIRED

03 - LEFT SIDE PANEL x1

09 - LEFT FRONT UPRIGHT x1

## HARDWARE REQUIRED

C  04  
Ø 3,5 x 30mm

## TOOLS REQUIRED

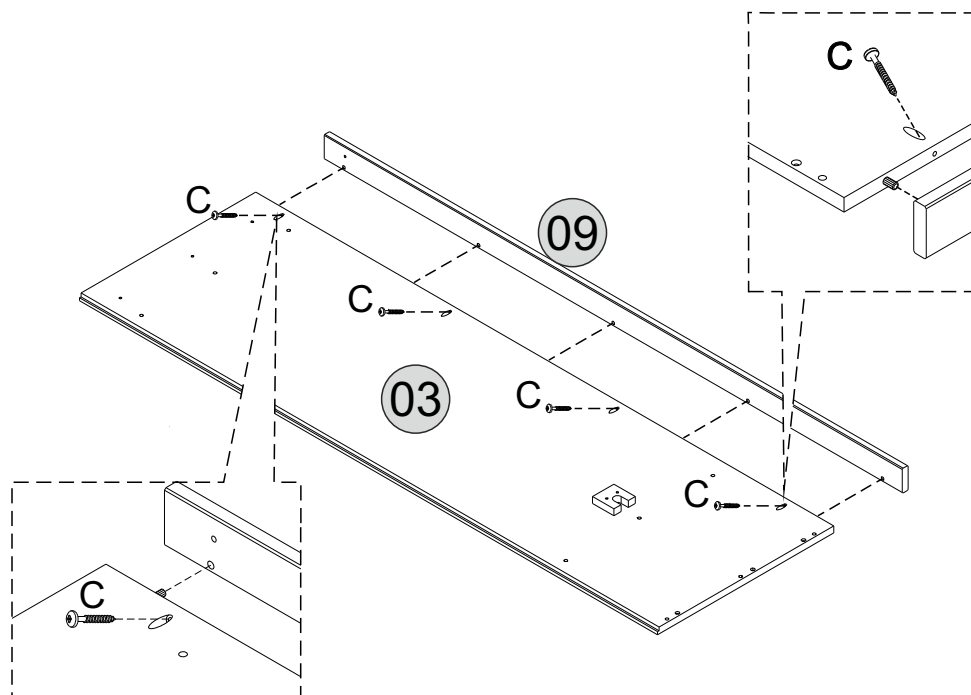
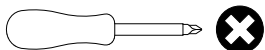

 Please assemble on a clean soft surface to avoid damage.

# STEP 7

## PARTS REQUIRED

13 - TOP SIDE PLINTH x1

21 - SIDE PLINTH x1

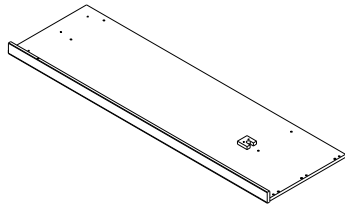

## HARDWARE REQUIRED

A  03  
Ø 4,5 x 30mm

K  03  
Ø 4,5 x 25mm

## TOOLS REQUIRED

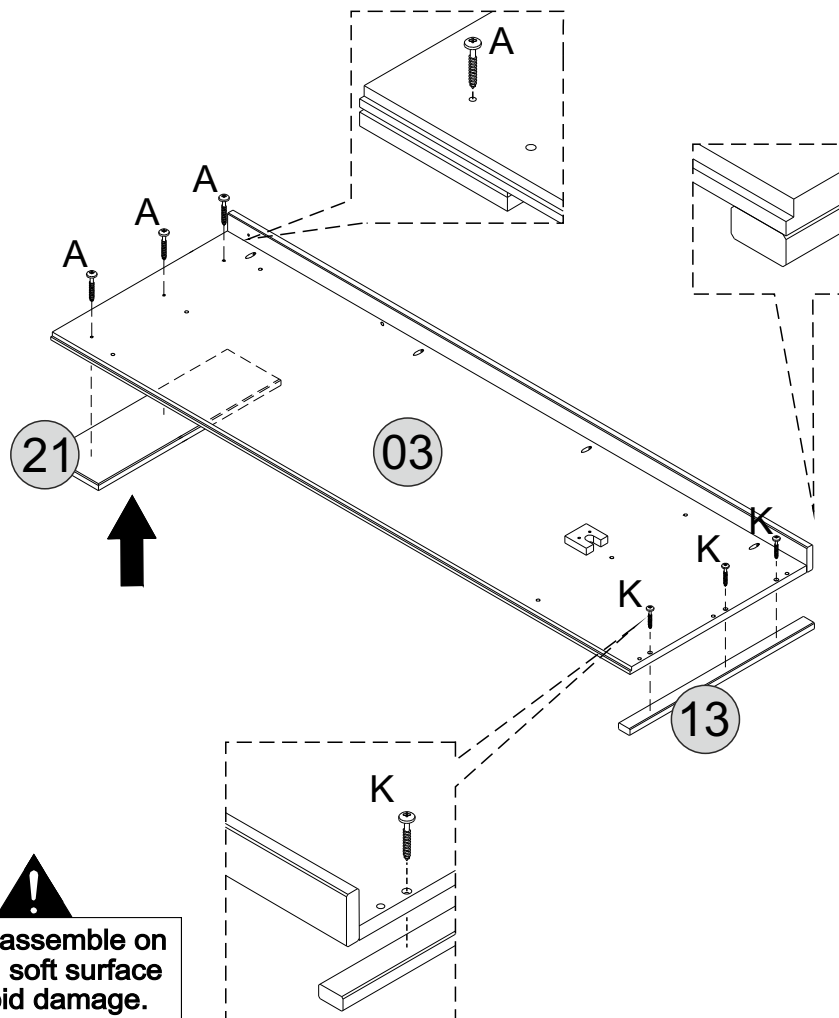
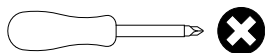

# STEP 8

## PARTS REQUIRED

17 - TOP MIDDLE PLINTH x1

18 - TOP BACK PLINTH x1

20 - TOP FRONT PLINTH x1

## HARDWARE REQUIRED

L  03  
Ø 4,0 x 45mm

## TOOLS REQUIRED

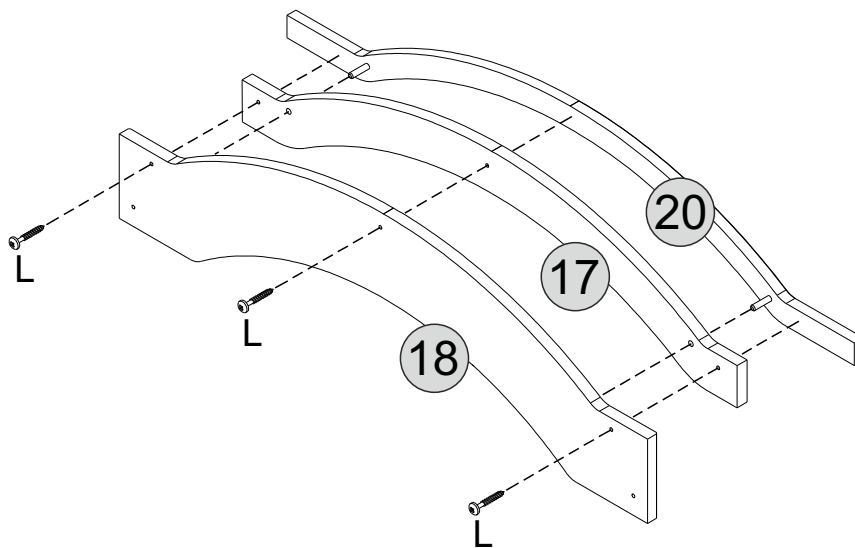
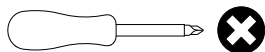

# STEP 9

## PARTS REQUIRED

01 - TOP PANEL (SMALL)	x1
04 - BASE	x1
14 - FIXED SHELF	x1

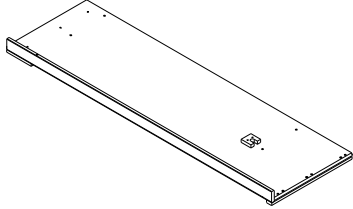

## HARDWARE REQUIRED

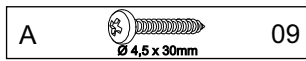

## TOOLS REQUIRED

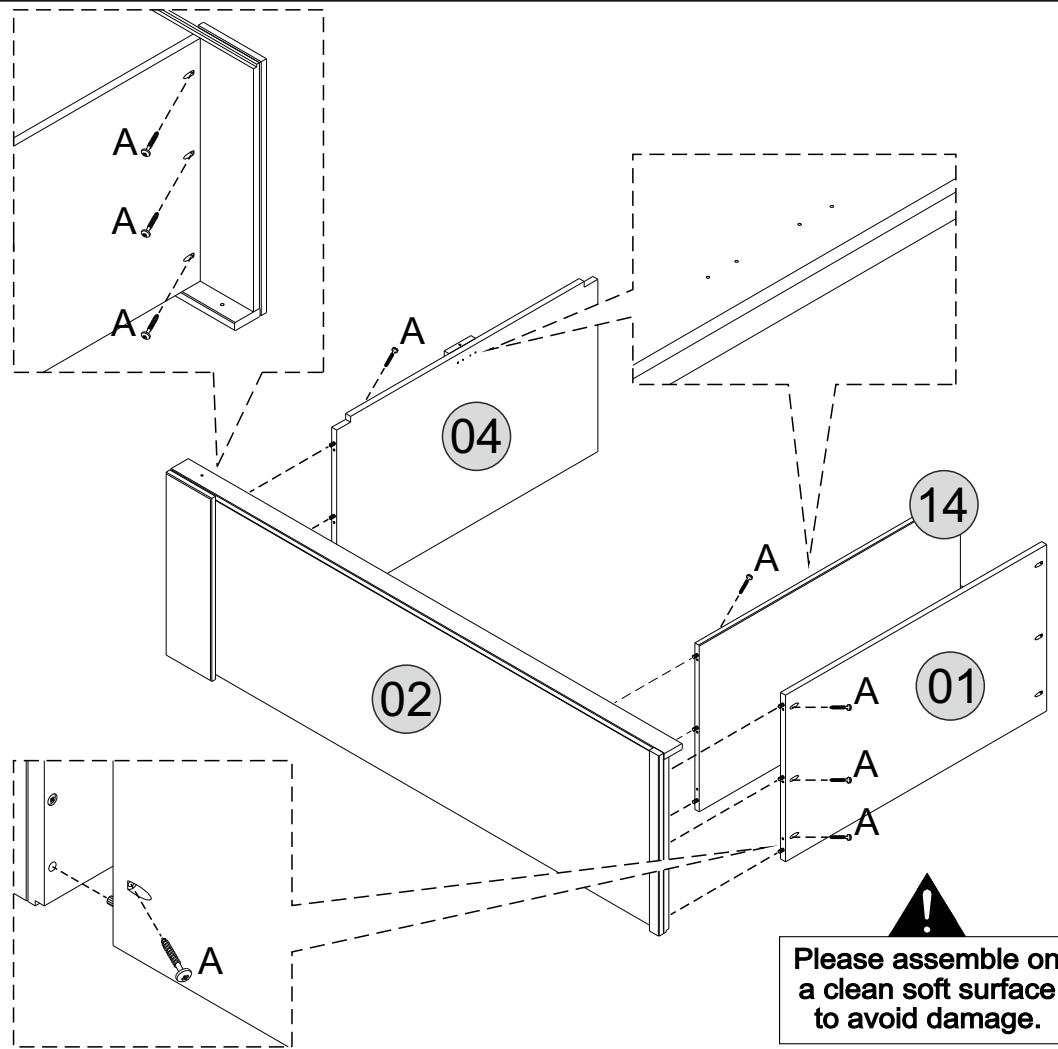
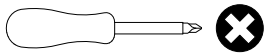

# STEP 10

## PARTS REQUIRED

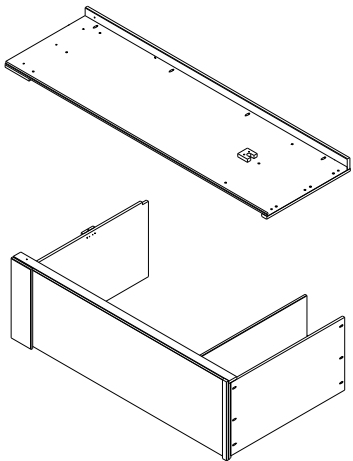

## HARDWARE REQUIRED

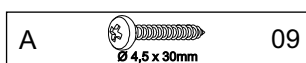

## TOOLS REQUIRED

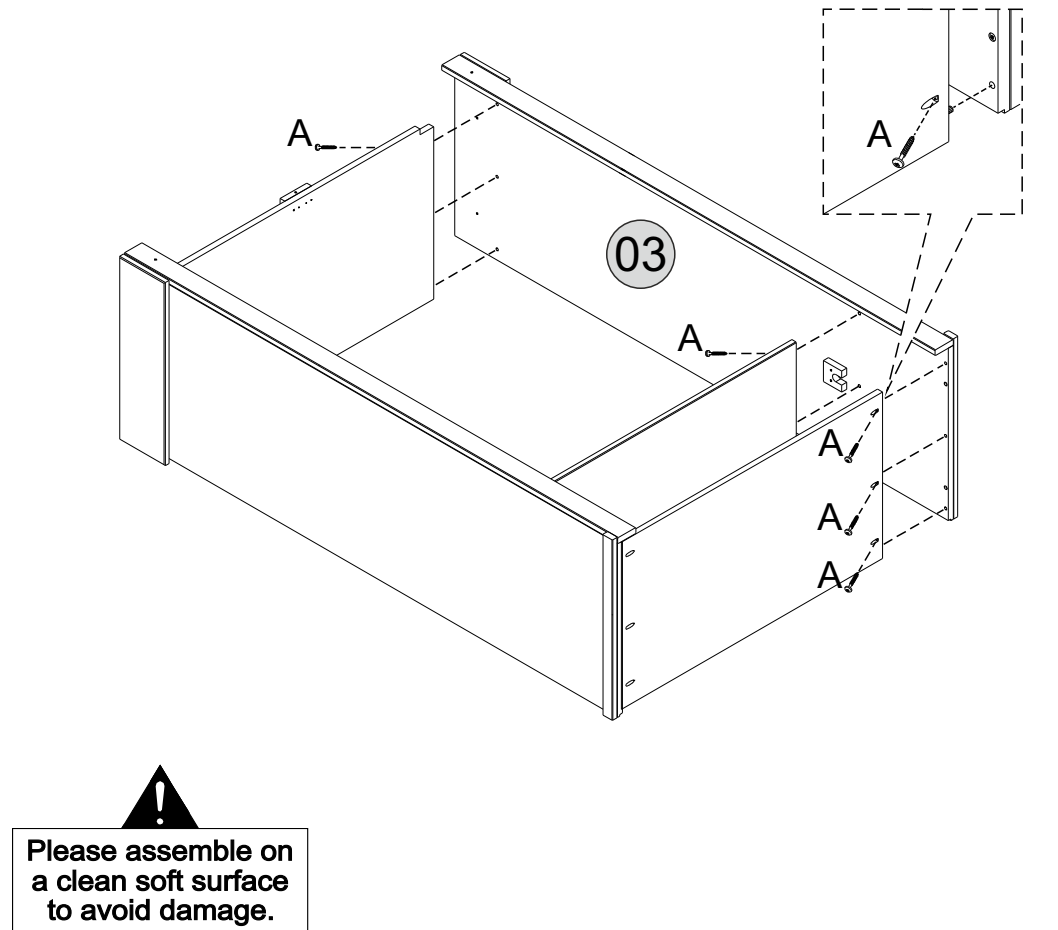
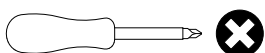

# STEP 11

## PARTS REQUIRED

08 - FRONT PLINTH x1

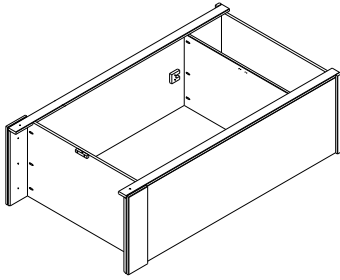

## HARDWARE REQUIRED

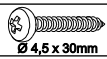
A  03  
Ø 4,5 x 30mm

## TOOLS REQUIRED

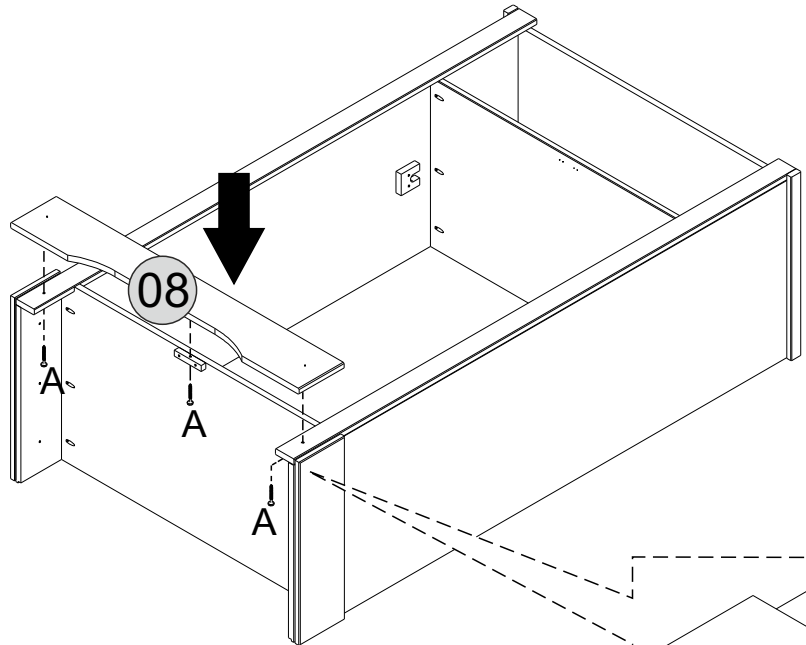
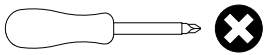

  
Please assemble on  
a clean soft surface  
to avoid damage.

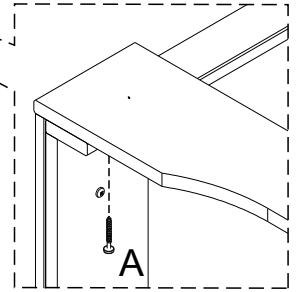

# STEP 12

## PARTS REQUIRED

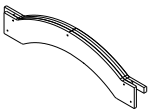
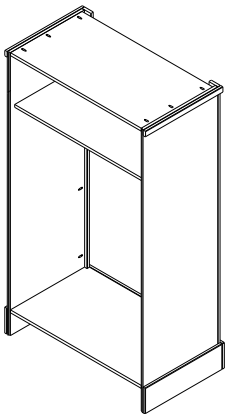

## HARDWARE REQUIRED

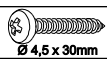
A  02  
Ø 4,5 x 30mm

## TOOLS REQUIRED

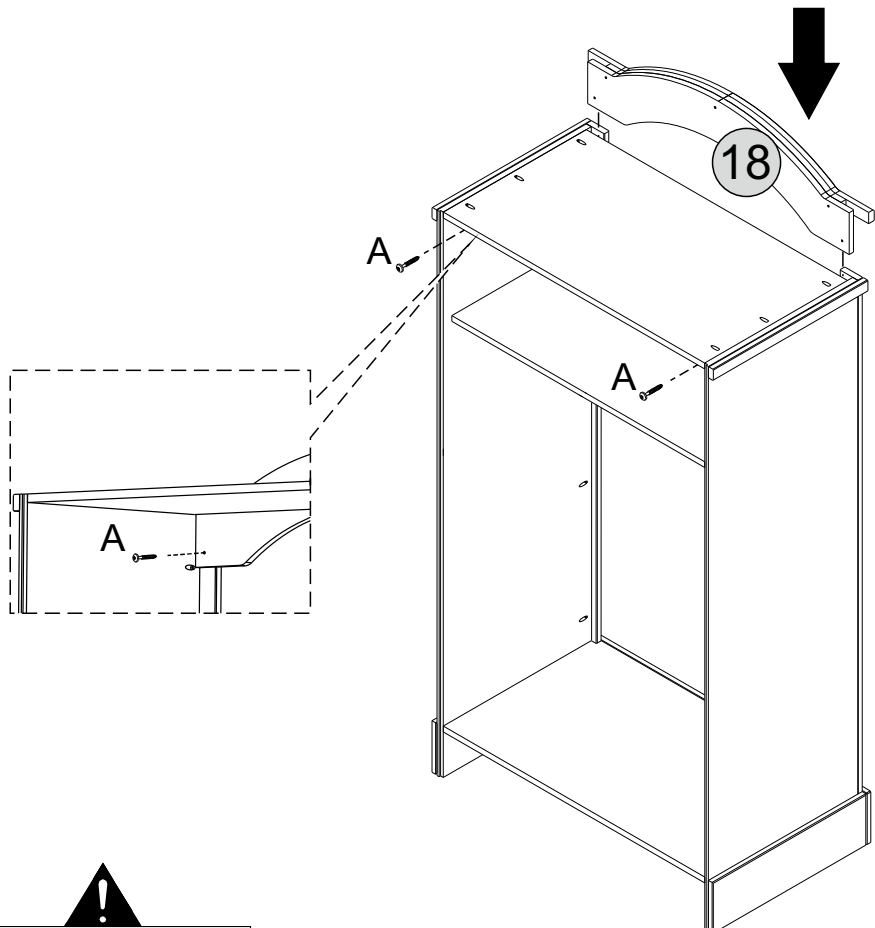
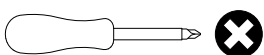

  
Please assemble on  
a clean soft surface  
to avoid damage.

# STEP 13

## PARTS REQUIRED

06 - HANGING RAIL x1

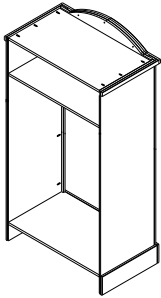

## HARDWARE REQUIRED

## TOOLS REQUIRED

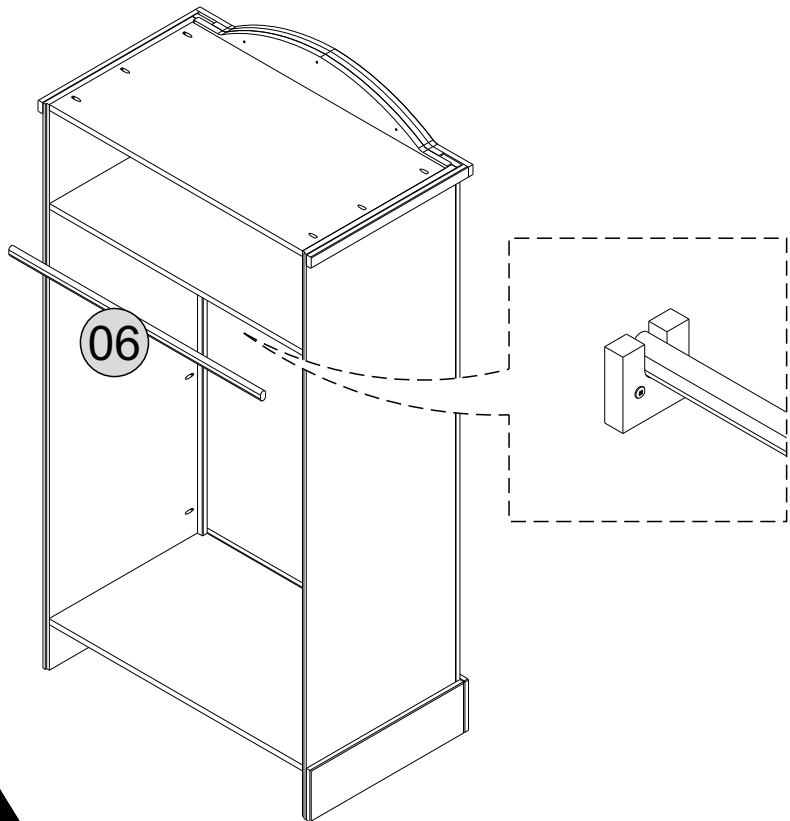

Please assemble on a clean soft surface to avoid damage.

# STEP 14

## PARTS REQUIRED

05 - BACK PANEL x2

07 - BOTTOM BACK PANEL STRIP x1

16 - UPPER BACK PANEL STRIP x1

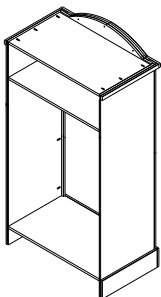

## HARDWARE REQUIRED

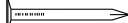
D  10 x 10 30

## TOOLS REQUIRED

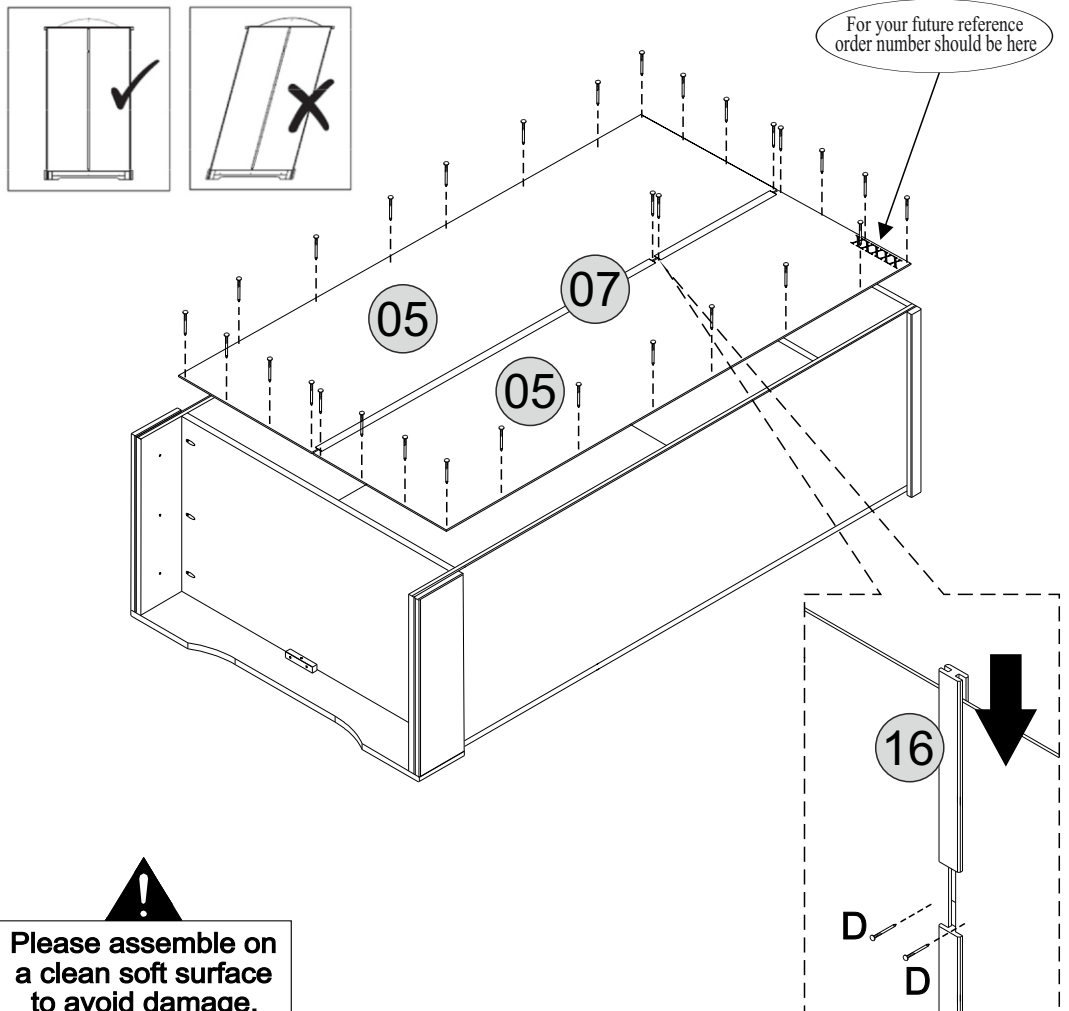
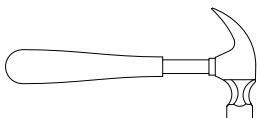

For your future reference order number should be here



Please assemble on a clean soft surface to avoid damage.

# STEP 15

## PARTS REQUIRED

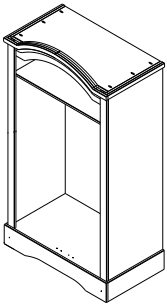

## HARDWARE REQUIRED

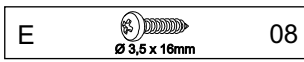

## TOOLS REQUIRED

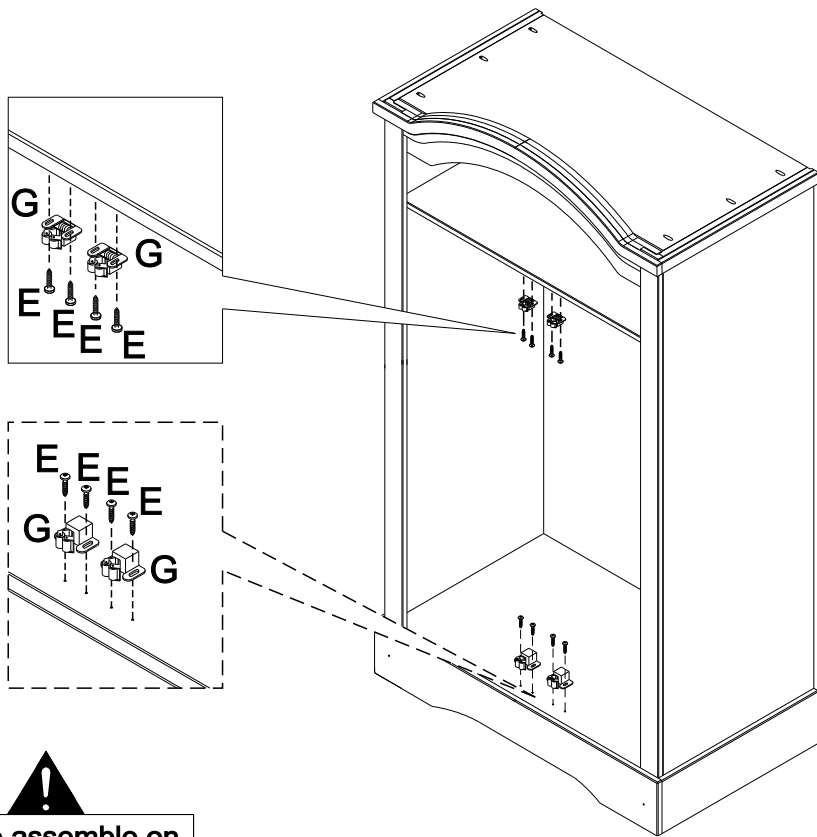
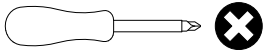

  
Please assemble on a clean soft surface to avoid damage.

# STEP 16

## PARTS REQUIRED

11 - LEFT DOOR	x1
----------------	----

12 - RIGHT DOOR	x1
-----------------	----

## HARDWARE REQUIRED

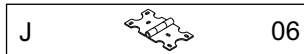
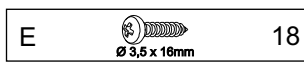

## TOOLS REQUIRED

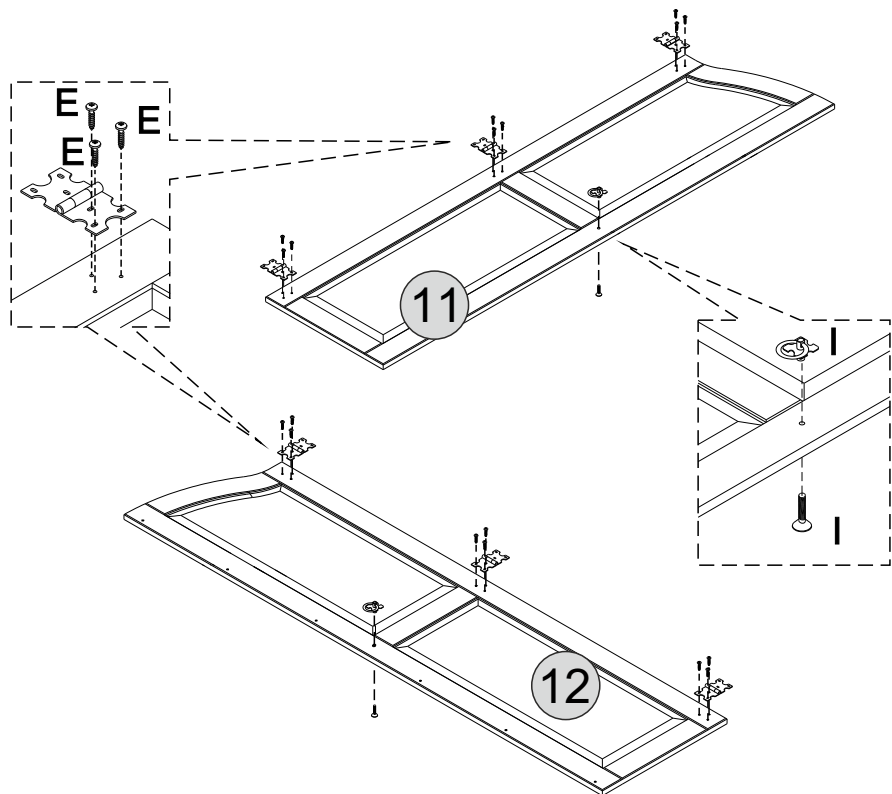
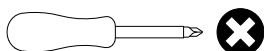

Please assemble on a clean soft surface to avoid damage.

# STEP 17

## PARTS REQUIRED

11 - LEFT DOOR x1

12 - RIGHT DOOR x1

15 - DOOR STRIP x1

## HARDWARE REQUIRED

E  08  
Ø 3,5 x 16mm

F  04

H  05  
Ø 4,0 x 20mm

## TOOLS REQUIRED

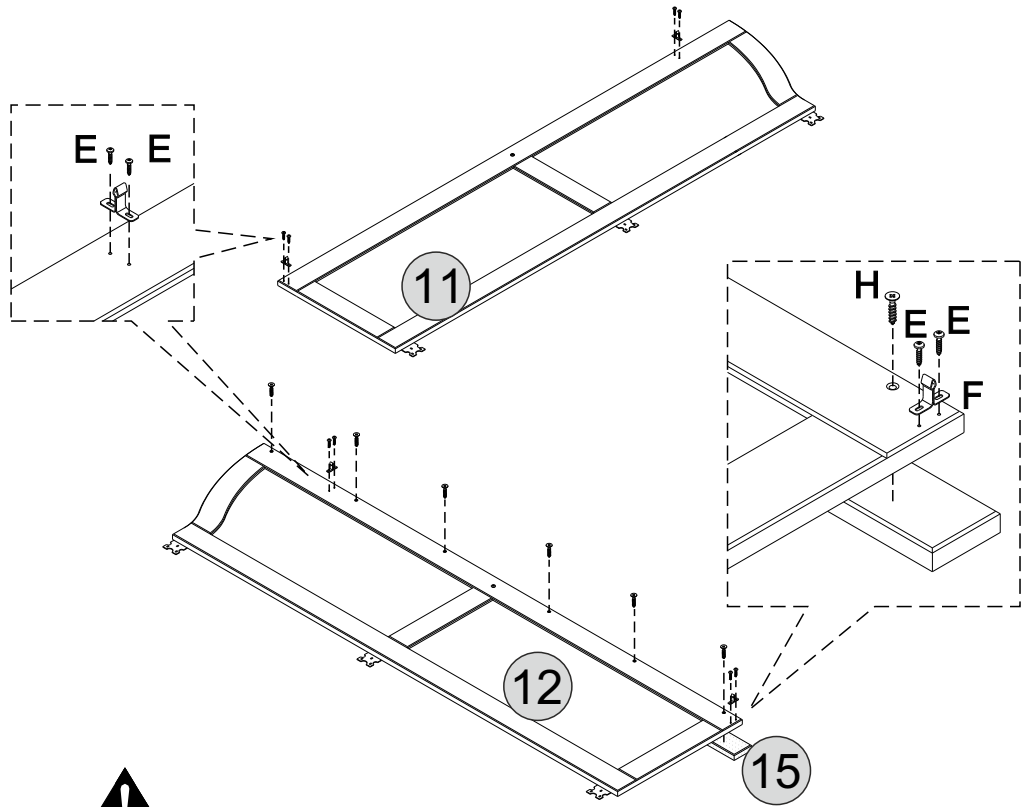
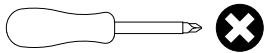

**!**  
Please assemble on a clean soft surface to avoid damage.

# STEP 18

## PARTS REQUIRED

11 - LEFT DOOR x1

12 - RIGHT DOOR x1

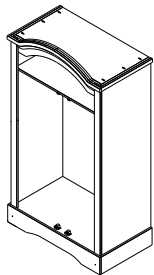

## HARDWARE REQUIRED

E  18  
Ø 3,5 x 16mm

N  02

## TOOLS REQUIRED

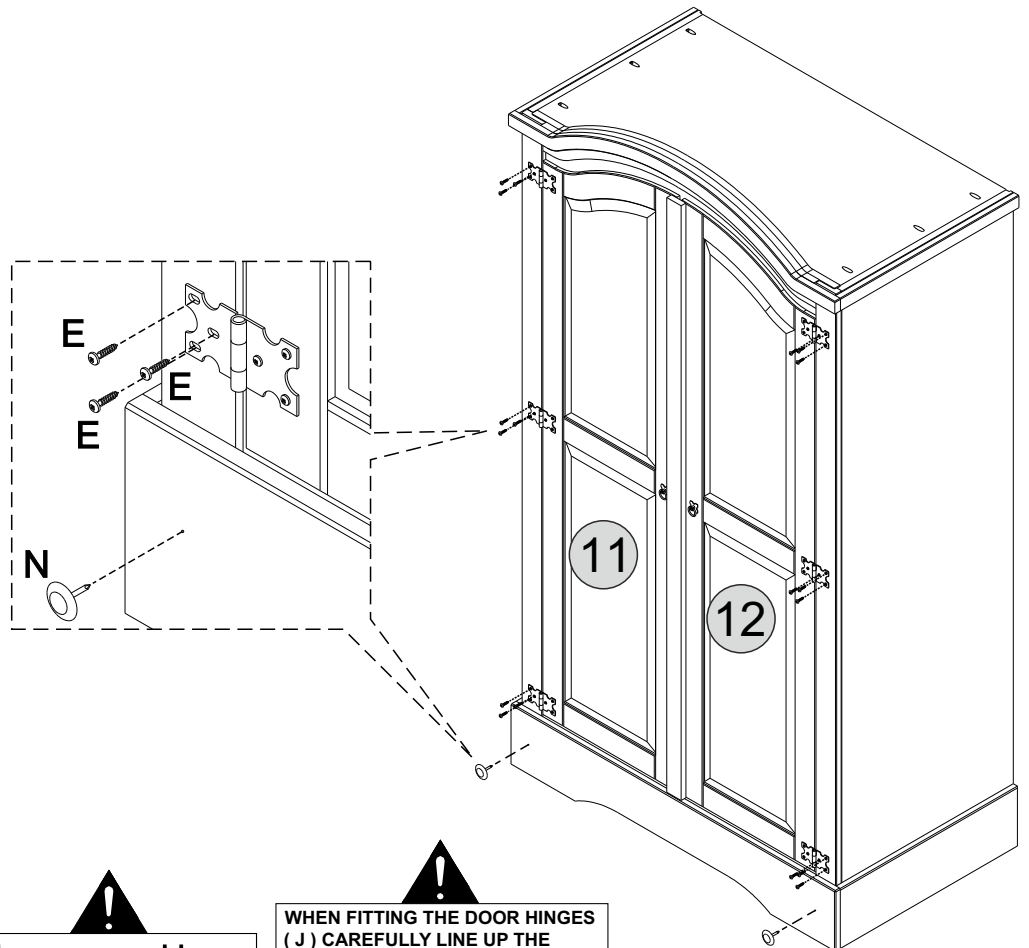
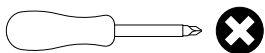

**!**  
Please assemble on a clean soft surface to avoid damage.

**!**  
WHEN FITTING THE DOOR HINGES ( J ) CAREFULLY LINE UP THE SCREW HOLES WITH THOSE PRE-MARKED ON THE SIDE, THIS WILL ENSURE THE DOORS HANG CORRECTLY.

# STEP 19

## PARTS REQUIRED

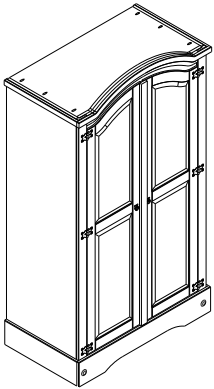

## HARDWARE REQUIRED

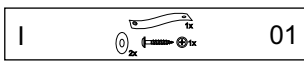

## TOOLS REQUIRED

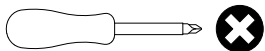

## WARNING

**Serious or fatal injuries can occur from furniture tipping over. To prevent the furniture from tipping over we recommend that it is permanently fixed to the wall.**

Wall fixings are not supplied with this product as different wall materials require different types of fixing devices. Please make sure you use fixings suitable for the walls in your home.

