

ASSEMBLY INSTRUCTIONS

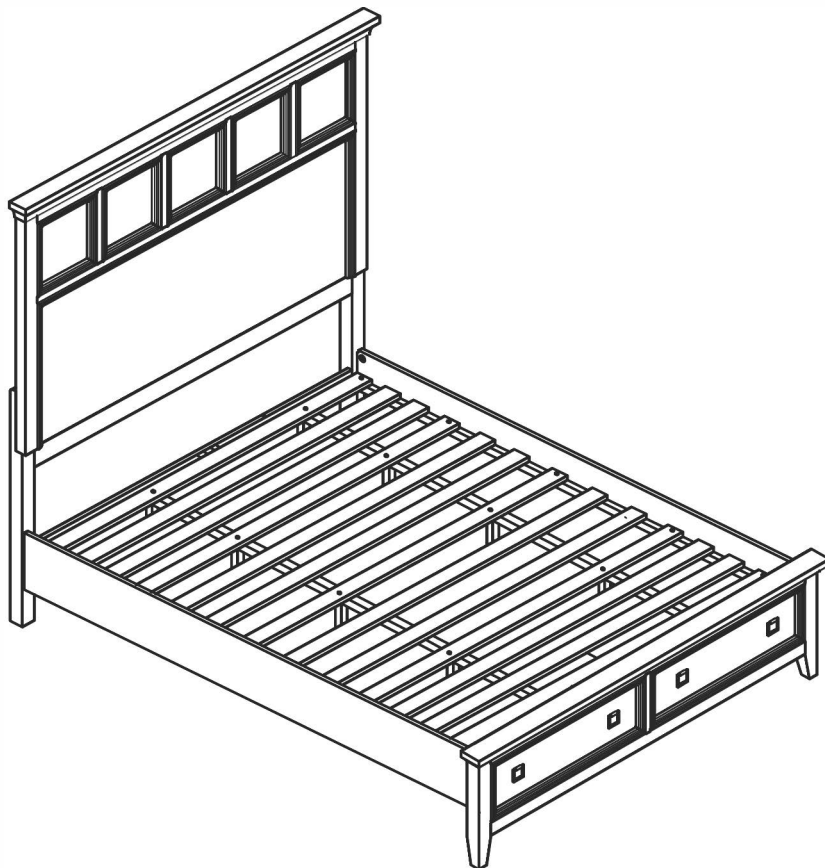

TOOLS REQUIRED



Allen Wrench

(Included)



Phillips
Screwdriver

(Not Included)

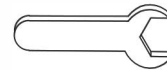

Wrench

(Included)

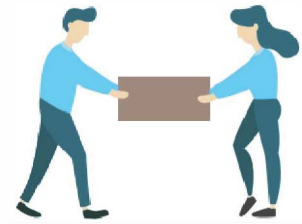

3 - People
Recommended

ASSEMBLY RATING



EASY → DIFFICULT

The Assembly Rating is a 5-point system showing the level of effort needed to assemble a specific product.



CHECK BEFORE STARTING

Are you missing anything?

Double-check all parts, hardware and accessories listed on Page 6 are accounted for.

Check out our Quick Tips!

We recommend reviewing the pre-assembly handouts. Even experts need a refresher now and then!

Should we send any replacements?

Are there any irregularities or flaws in the parts? We can send replacements!

Prep Time!

Please review the assembly instructions and all diagrams prior to assembling. Arrange parts as recommended on Page 7 and group identical hardware together to make assembling easier.

PRE ASSEMBLY INTRODUCTION

We understand building ready-to-assemble furniture can be a challenging experience for some. To help avoid confusion, we have provided some helpful tips that may speed up the process.

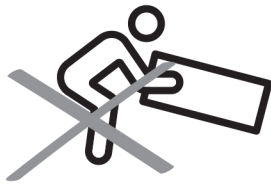

Teamwork

ALWAYS have at least two people to help with transporting and assembling the product to avoid potential injury and/or damage.



Suitable Location

Assembling near the area of the intended location is highly recommended.



Sufficient Space

Make sure you have enough space to move around during the assembly.



Avoid Scratches

Use cardboard, blankets or a carpeted area while assembling furniture to prevent scratches.

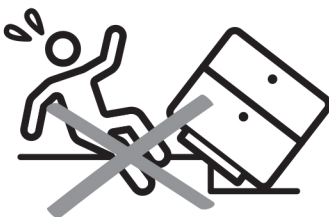

Flat Surface

Make sure the furniture rests on a flat and level surface with each leg evenly touching the floor.

ASSEMBLY AND CARE ADVICE



FAILURE TO FOLLOW THE GUIDELINES BELOW MAY RESULT IN INJURY AND/OR PROPERTY DAMAGE.



Position each part correctly and insert screws or bolts into their respective holes.



Turn clockwise to tighten and only tighten when step is completed or when instructed to do so.



Use the appropriate hand tools or power tools for assembly. Select steps, such as tightening screws and/or bolts, may require hand tools to avoid causing damage during assembly.



Save the instructions and store any supplied tools for later maintenance.



After two weeks, check and tighten any loose hardware and repeat again every six months thereafter.





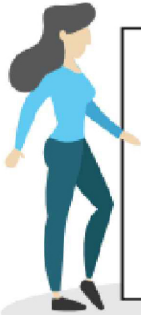
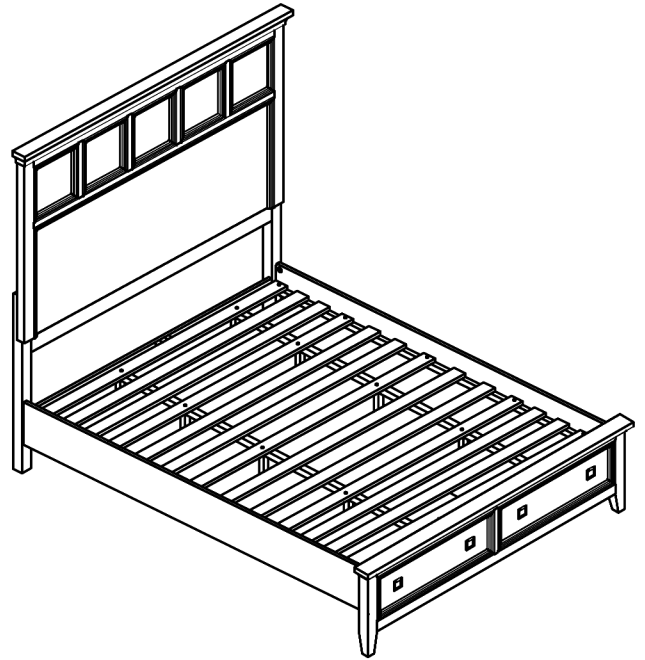

IT IS THE USER'S RESPONSIBILITY TO MAINTAIN THE FURNITURE. THE HARDWARE MAY LOOSEN OVER TIME AND MAY CAUSE THE FURNITURE TO BE WOBBLY AND UNABLE TO SUPPORT ITS INTENDED WEIGHT CAPACITY. THIS MAY LEAD TO COLLAPSE AND MAY CAUSE SERIOUS INJURY.

E.KING BED

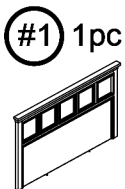
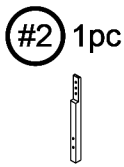
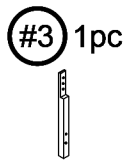

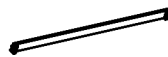
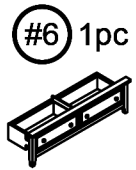

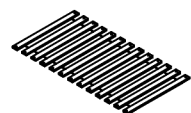





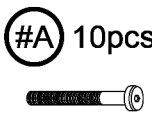
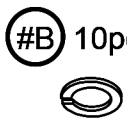
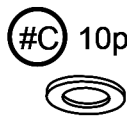
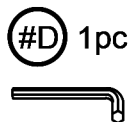



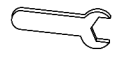



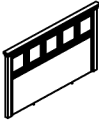

• Please keep instructions for future reference.
 • Check the quantity and irregularity of parts and hardware before you start.

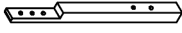
PARTS

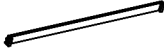
				
Headboard	Right Headboard Leg	Left Headboard Leg	Stretcher Top	Stretcher Middle
				
Storage Footboard	Side Rail	Slat Support Leg 390x30x30	Slats(13pcs)	Crossbar

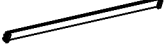
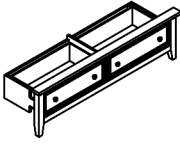
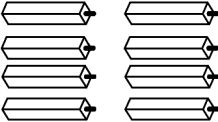
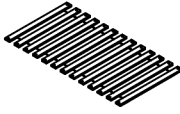
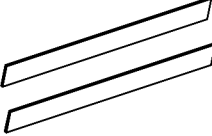
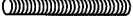
HARDWARE

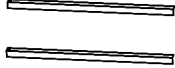
				
Bolt Ø5/16" x 1-1/2"	Lock Washer Ø5/16"	Flat Washer Ø5/16"	Allen Wrench 4mm	Threaded Bolt 5/16" x 3"
				
Hex Nut 5/16" x 12mm x 6mm	U-Square Flat Washer 5/16"	Spring Washer 5/16" x Ø11x1.1mm	Wrench 12mm x 87mm	Long Screw Ø8 x 30mm

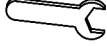
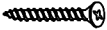
Carton	Disignation	Part	Part	Hardware
	Headboard	#1		 #A 10pcs
	Right Headboard Leg	#2		 #B 10pcs
	Left Headboard Leg	#3		 #C 10pcs
	Stretcher Top	#4		 #D 1pc
	Stretcher Middle	#5		
	Storage Footboard	#6		
	Slat Support Leg	#8		
	Slats(13pc)	#9		
	Side Rail	#7		 #E 8pcs  #F 8pcs
	Crossbar	#10		 #G 8pcs  #H 8pcs  #I 1pc  #J 22pcs

ASSEMBLY INSTRUCTIONS

1

Exploded View

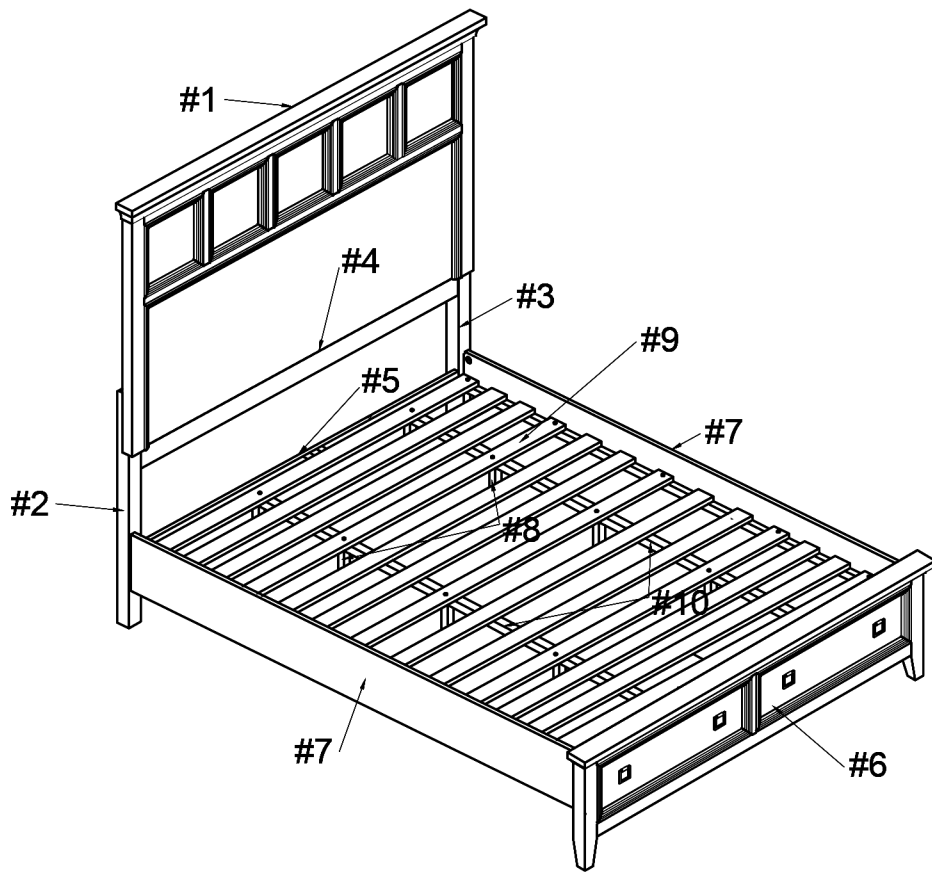

2

Part #2 x1pc

Part #3 x1pc

Part #4 x1pc

Part #5 x1pc

Hardware #A x4pcs

Hardware #B x4pcs

Hardware #C x4pcs

Align stretchers (#4,5) to the HB legs (#2,3), then secure by using bolts (#A) with washers (#B,C).

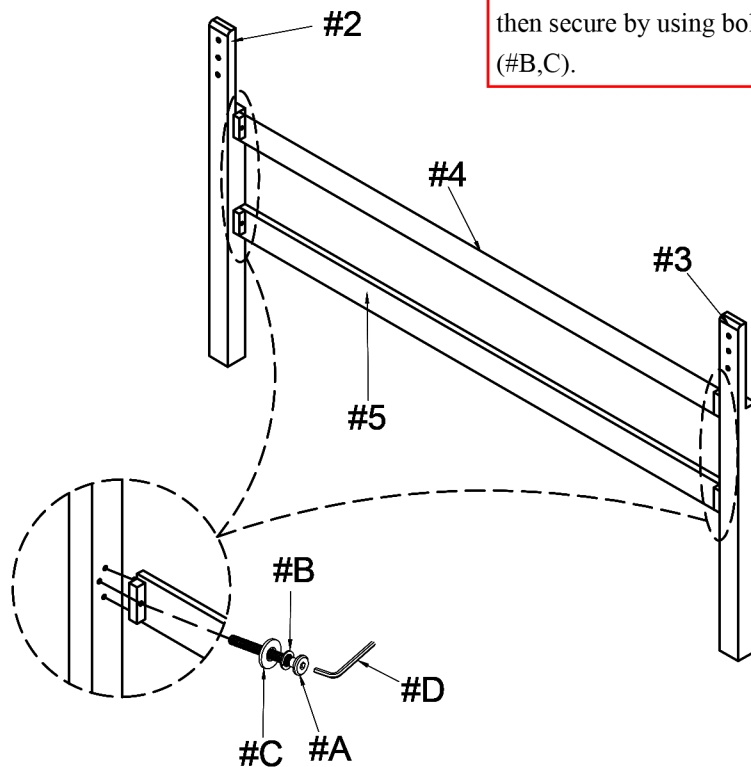

ASSEMBLY INSTRUCTIONS

3

Part #1 x1pc

Hardware #A x6pcs

Hardware #B x6pcs

Hardware #C x6pcs

Align HB legs to the headboard, then secure by using bolts (#A) with washers (#B,C). Please ensure that the dowel on headboard (#1) is inserted to the top stretcher.

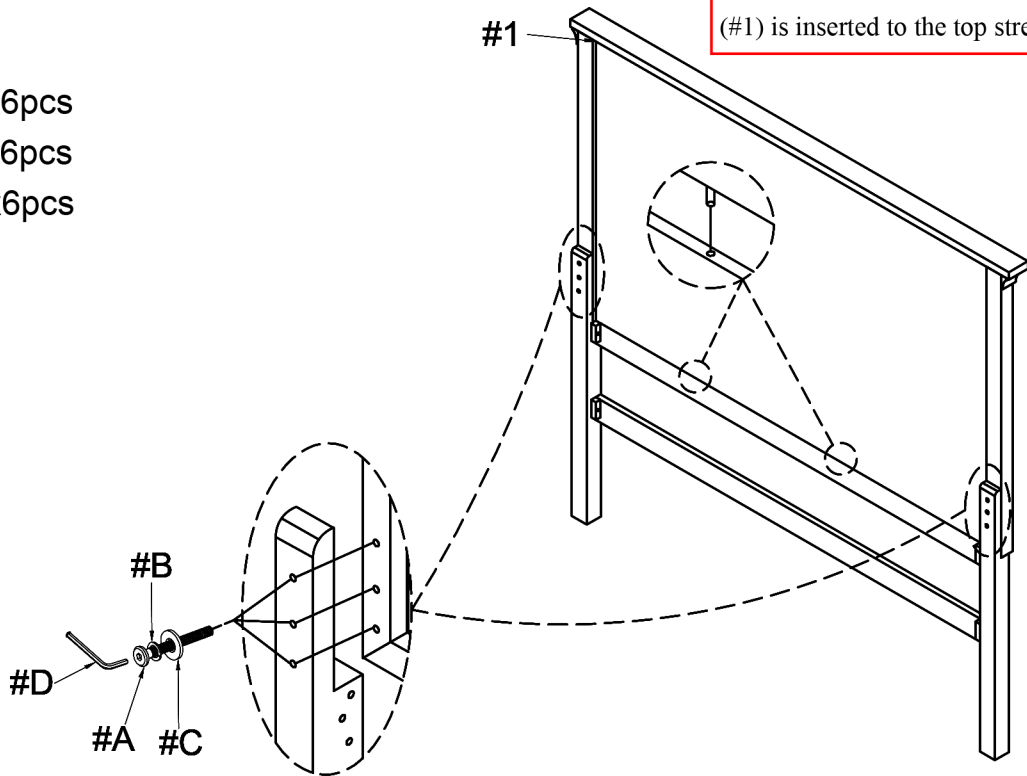

4

Part #8 x 4pcs

Part #10 x1pc

Align and attach support legs (#8) to the crossbars (#10).

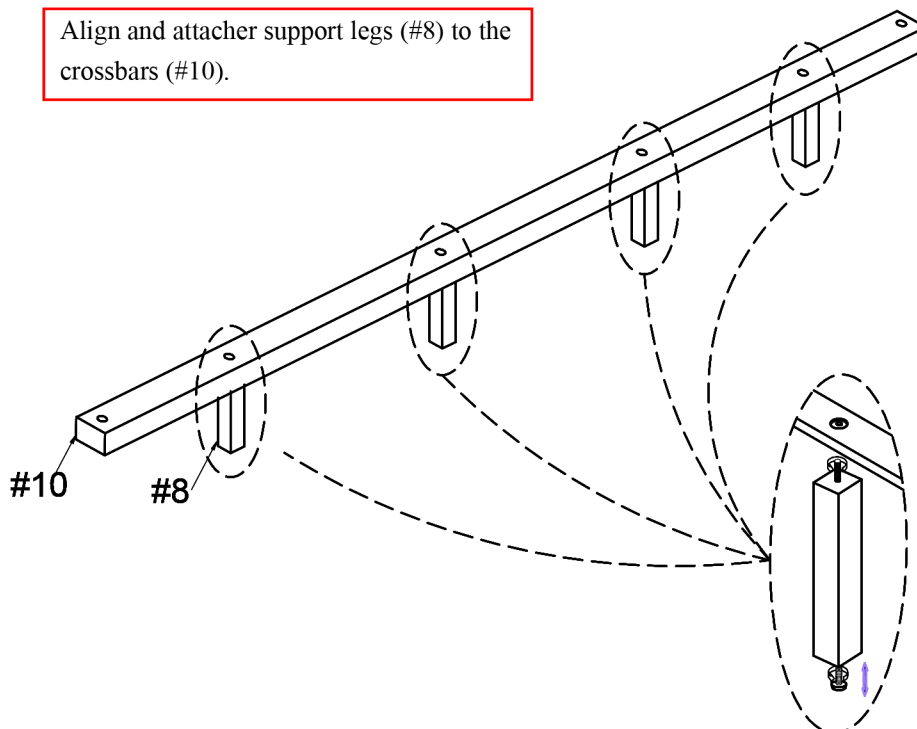

x 2

ASSEMBLY INSTRUCTIONS

5

Part **#6** x 1pc

Part **#7** x 2pcs

Hardware **#E** x 8pcs

Hardware **#F** x 8pcs

Hardware **#G** x 8pcs

Hardware **#H** x 8pcs

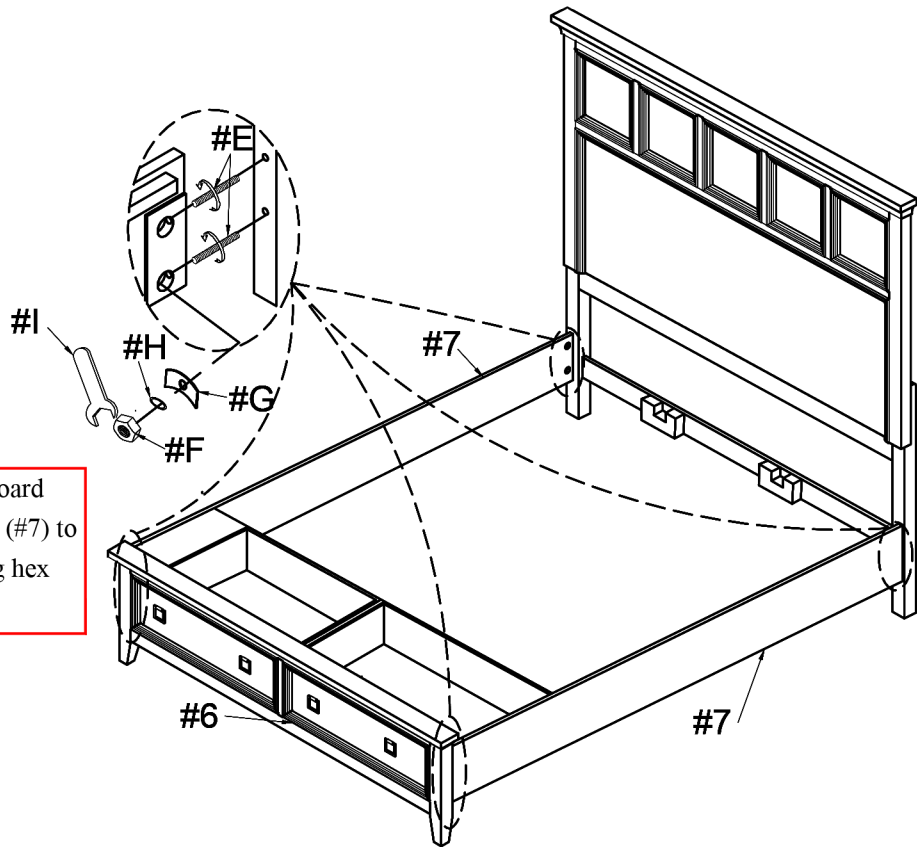

Attach threaded bolts (#E) to the headboard and footboard (#6), then align side rails (#7) to the threaded bolts (#E). Secure by using hex nuts (#F) with washers (#H,G).

6

Hardware **#J** x 4pcs

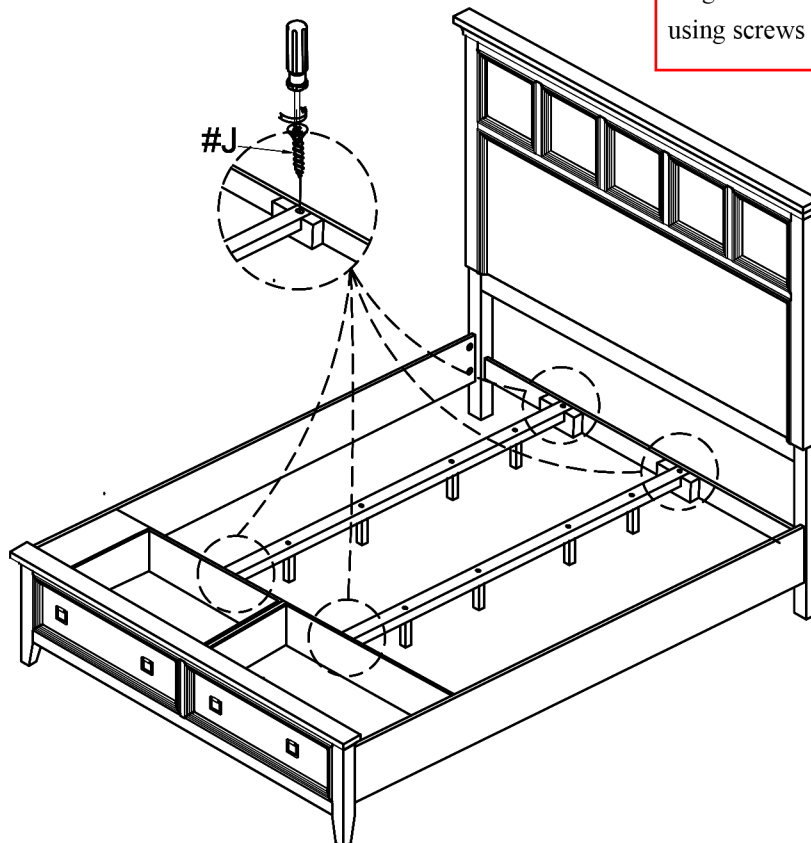

Align slats to the bed, then secure by using screws (#J).

ASSEMBLY INSTRUCTIONS

7

Part (#9) x 1 set

Hardware (#J) x 18pcs

Align slats (#9) to the bed, then secure by using screws (#J).

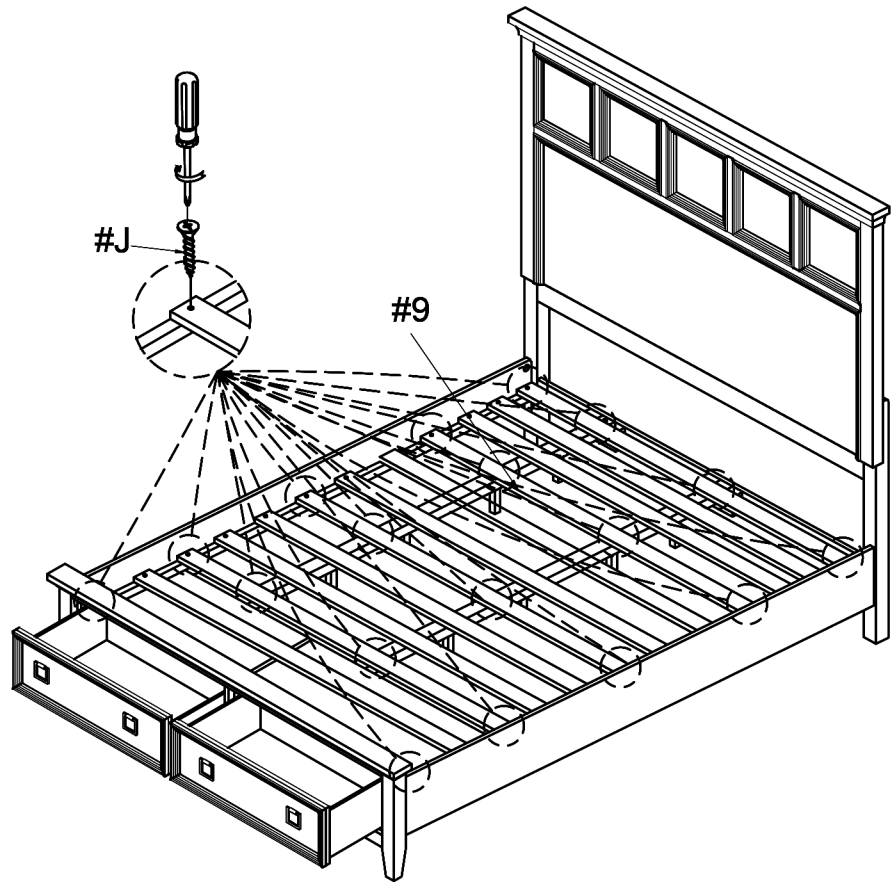

8

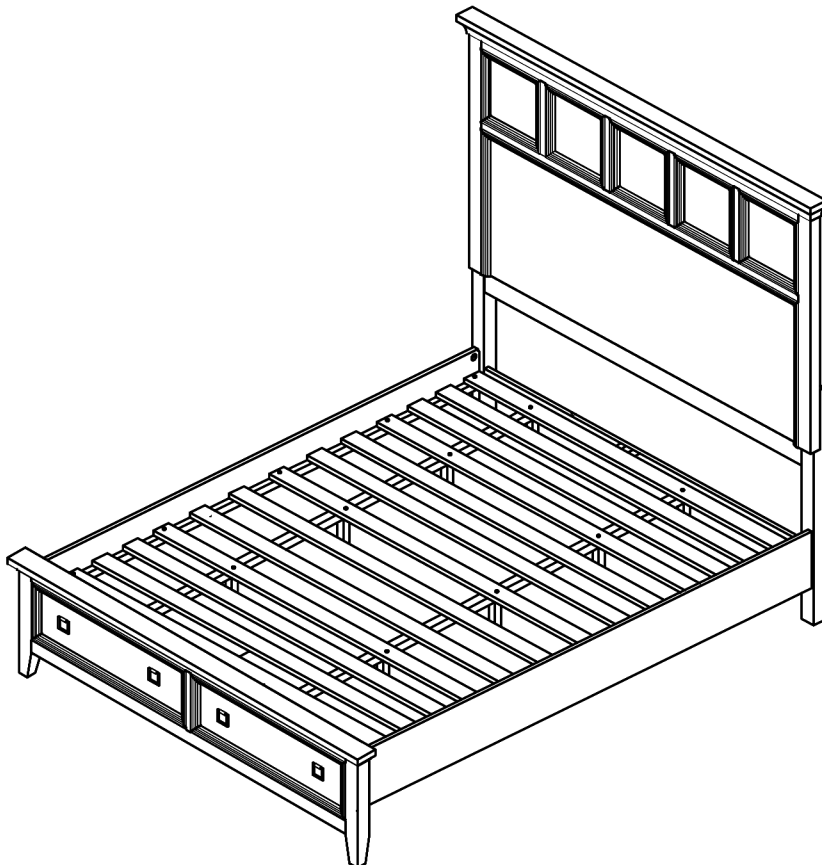

ASSEMBLY COMPLETED



Please ensure the furniture rests on an even and flat surface. If the product wobbles or feels loose, double-check all bolts and/or screws are properly tightened and secured.

✓ Keep this handy!

Please retain this instruction manual and any order-related information for future reference.

✓ Lift, don't drag!

To avoid damage to product please always LIFT the product when transporting or adjusting the placement.