

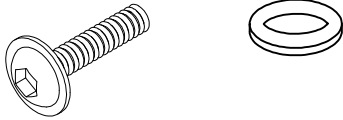







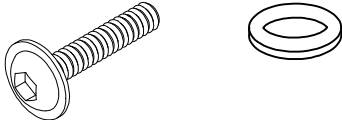

IMPORTANT, RETAIN FOR FUTURE REFERENCE: READ CAREFULLY

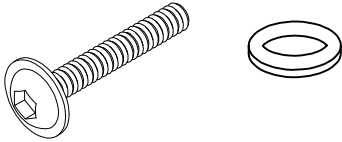
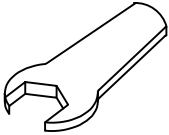
Notice:

1. Follow the installation instructions. Please confirm all accessories are preset before installation.
2. Do not fully tighten the screws during initial assembly. Fully tighten screws only once all pieces which are correctly assembled.
3. If you encounter any problems during installation, refer to two solutions: Follow the installation video tutorial on the Amazon product page or contact our customer service.

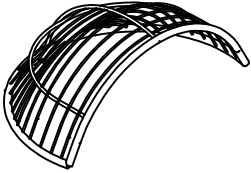
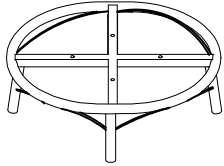
Item no.	Reference Image	Qty	Item no.	Reference Image	Qty
A	 M6*35mm	X4+1	E		X18+1
B	 M6*38mm	X12+1	-		X1
C	 M6*55mm	X6+1	-		X1
D		X22+2			
 Tips: The number after "+" represents the spare screws.			 Tips: The number after "+" represents the spare screws.		

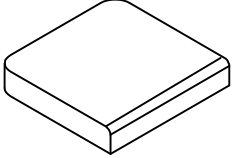
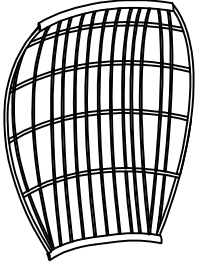
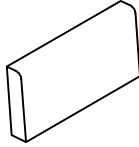
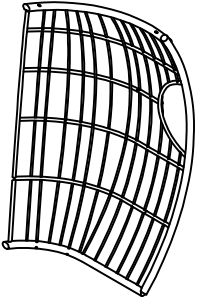
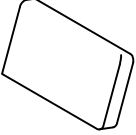
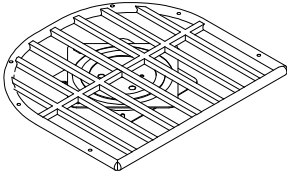
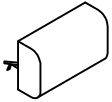
Item no.	Reference Image	Qty	Item no.	Reference Image	Qty
1		X1	6		X1
2		X1	7		X1
3		X1	8		X1
4		X1	9		X2
5		X1	10		X1

Explosion Diagram

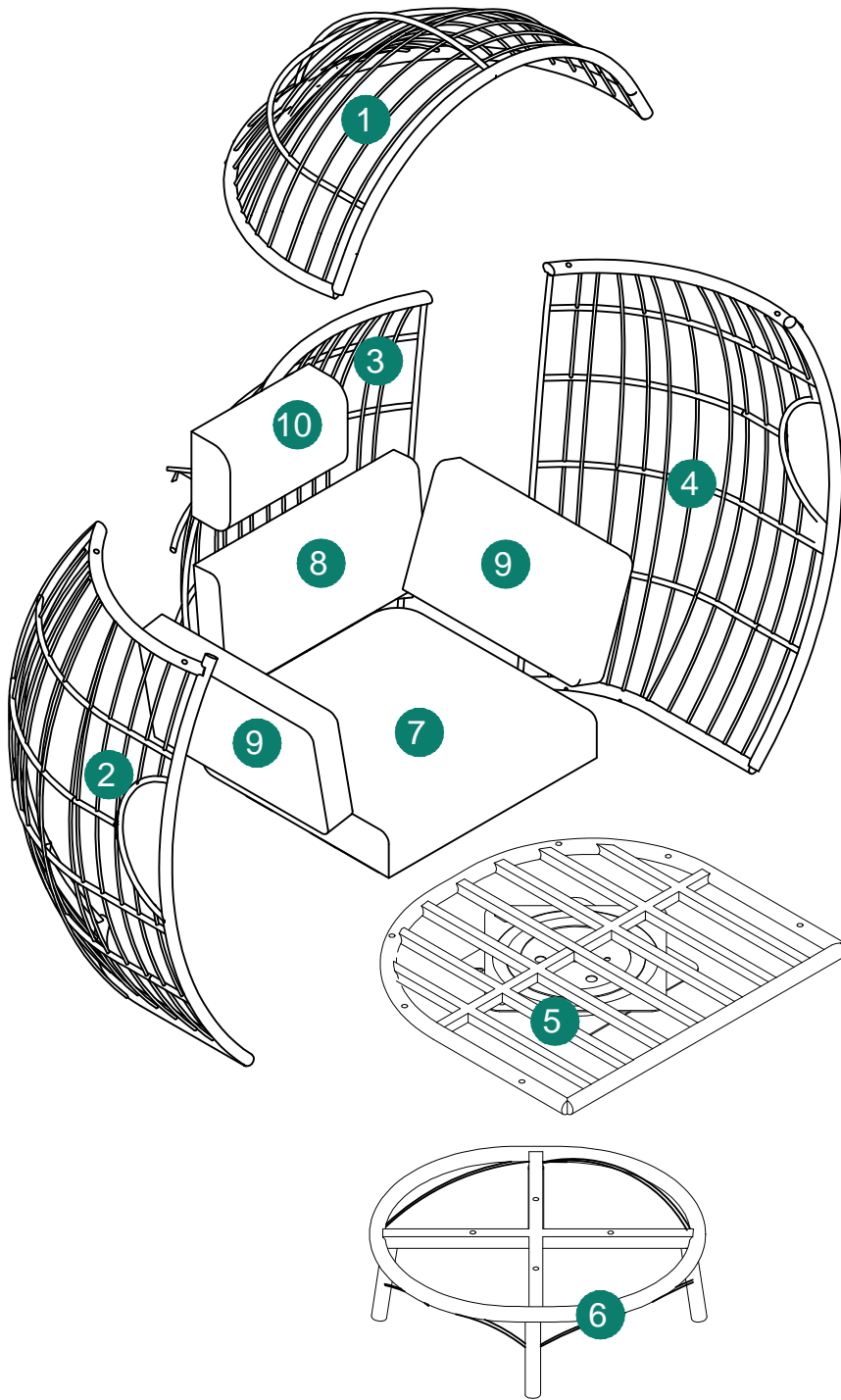

1



Ⓑ 6pcs



Ⓓ 6pcs



Ⓔ 6pcs

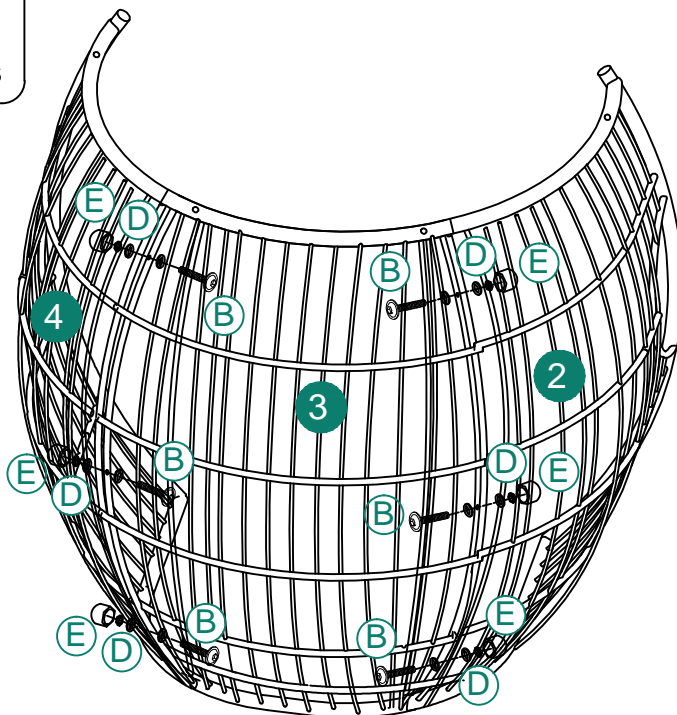
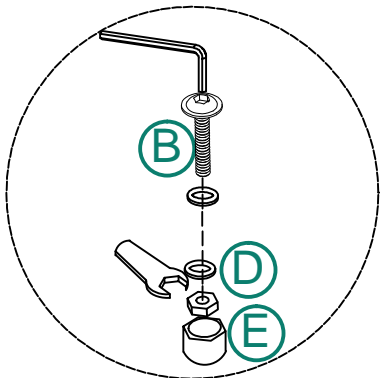

2



Ⓑ 6pcs



Ⓓ 6pcs



Ⓔ 6pcs

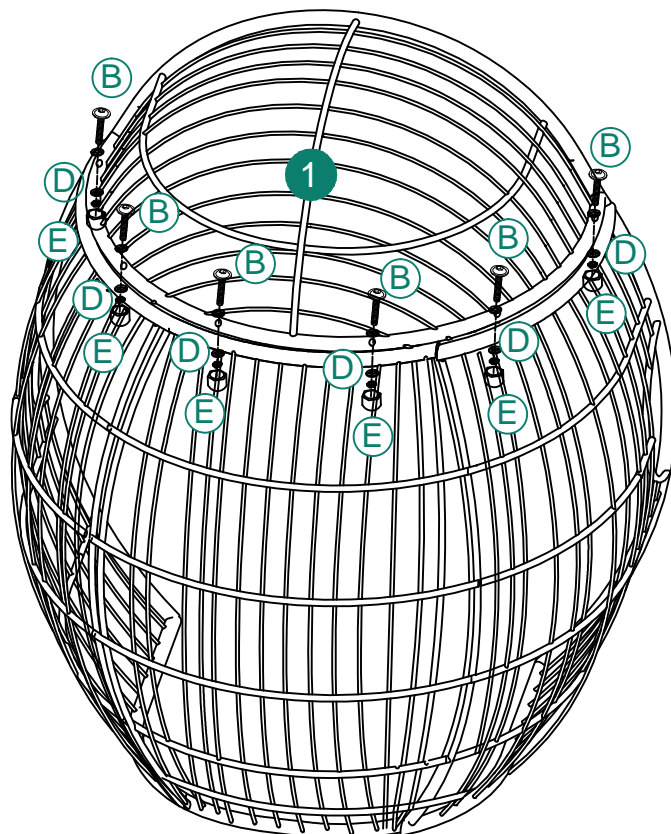
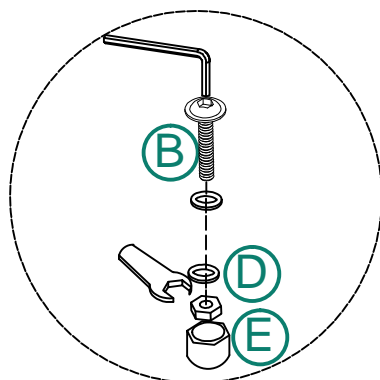

3



Ⓒ 6pcs



Ⓓ 6pcs



Ⓔ 6pcs

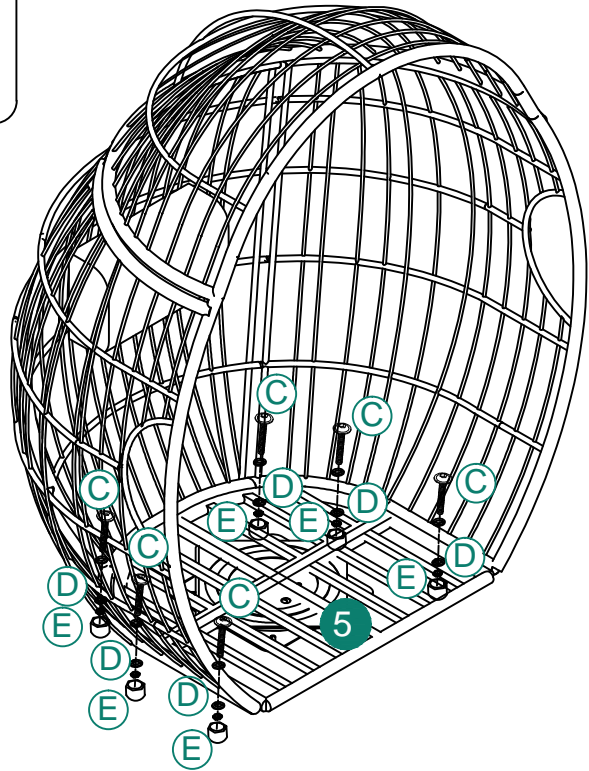
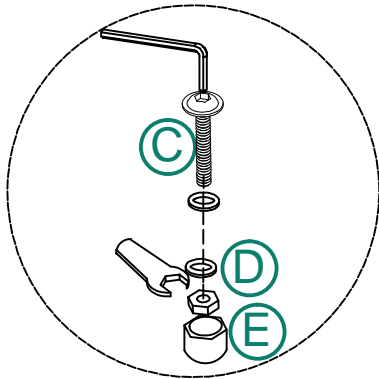

4



Ⓐ 4pcs



Ⓓ 4pcs

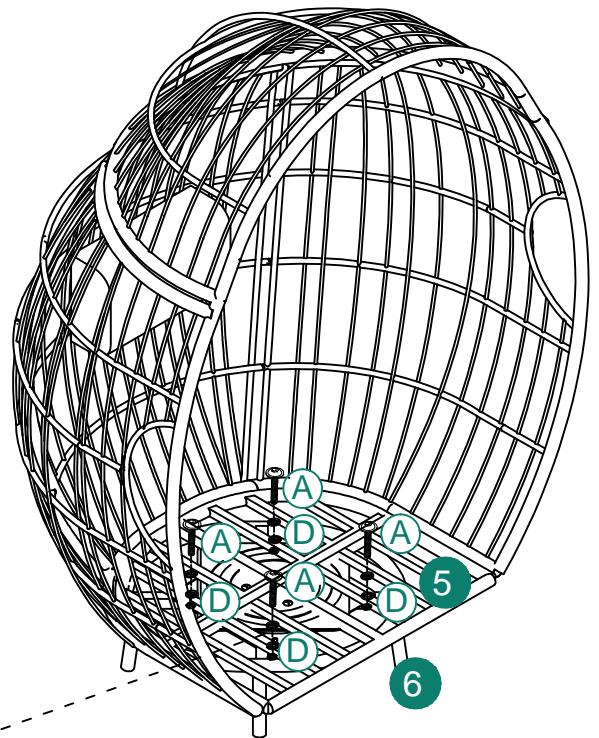
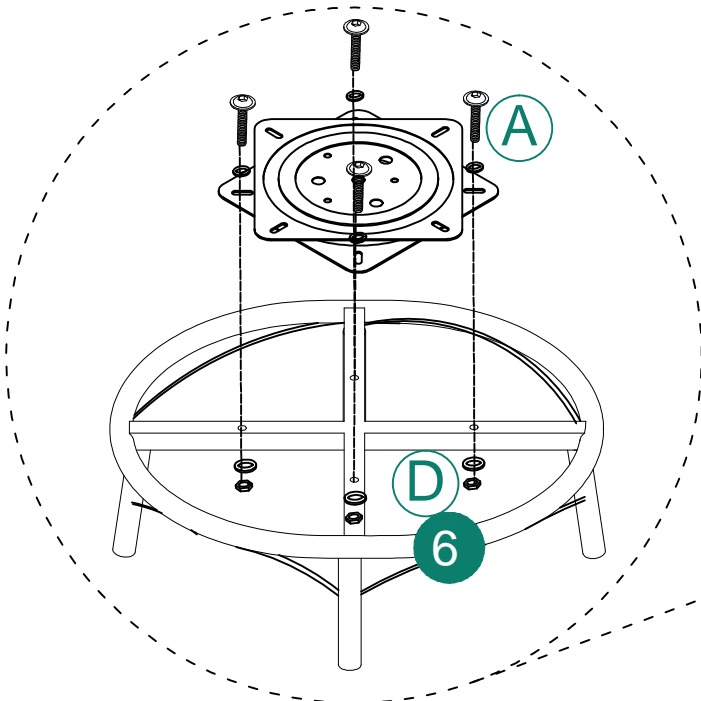

5

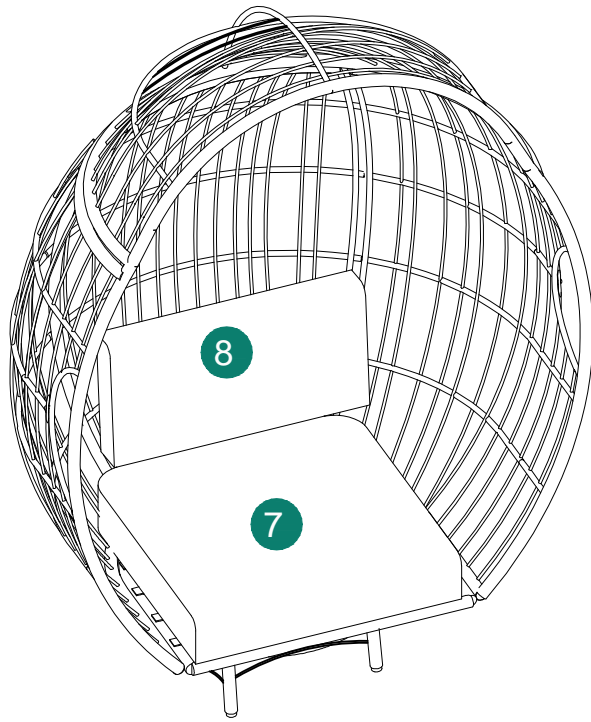

6

