

Main Street Planter Lite®



Shown in Onyx Black

Lite® Collection

Lite® planters are rated for both indoor and outdoor use and frequently specified for rooftops and terraces, hospitality projects, public space installations, and restaurants. They are a great choice for jobs that do not allow for heavy-weight materials and where large scale plantings are required. Because of their light weight, fiberglass planters are easier to ship and material handle on the job. Fiberglass planters can withstand UV exposure and extreme temperatures, from high heat to frost and can tolerate the seasonal thaw cycles. Additionally, they won't corrode due to exposure or direct contact with soil. There is no need to use plastic liners with Campania's Lite® planters. Although we recommend that you take advantage of the quick turnaround of our stocked product; these shapes, finishes, and/or sizes are not always right for every job. Campania has the capability to produce custom shapes, sizes, and colors in our Vietnamese factory. All recommended commercial products and CAD files can be viewed at www.campaniainternational.com/projects. Our full line can be viewed online at www.campaniainternational.com/liteproducts.



InLine Saucer
Shown in Lead

Material	Texture	Item Description	Item #	Available Colors	Outside Dimensions	Inside Top Dimensions	Base Dimensions	Weight	Approx. Soil Capacity	Matching InLine Saucer Item #
Fiberglass	Standard	Main Street Tall Planter	94-138-13901 94-138-3401	(139) Onyx Black (34) Lead	31.5"L x 11.75"W x 26.75"H	30.25"L x 10.75"W	31.5"L x 11.75"W	29 lbs	5.5 cu ft.	94-138-13901S 94-138-3401S
Fiberglass	Standard	Main Street Planter	94-139-13901 94-139-3401	(139) Onyx Black (34) Lead	31.5"L x 11.75"W x 15.75"H	20.25"L x 10.5"W	31.5"L x 11.75"W	17 lbs	3.5 cu ft.	94-139-13901S 94-139-3401S

Note: Each planter is equipped with drainage holes.

A shelf is available to decrease the amount of soil you will need to fill the planter.

Shelf Insert sold separately: Item #94-001-3401

AVAILABLE COLORS

Please note: Actual colors may vary slightly from those depicted below. Color samples are available upon request. Call 215-541-4330 for more info.

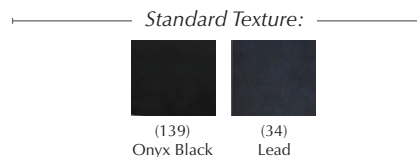

Main Street Planter Lite[®]

Profile View

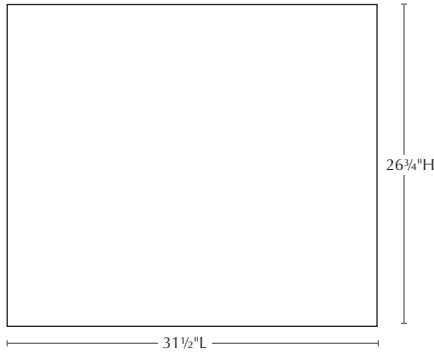

Top View

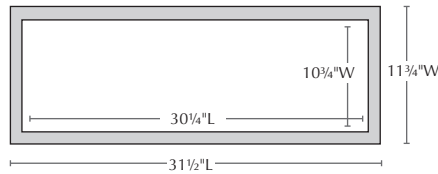

Isometric View

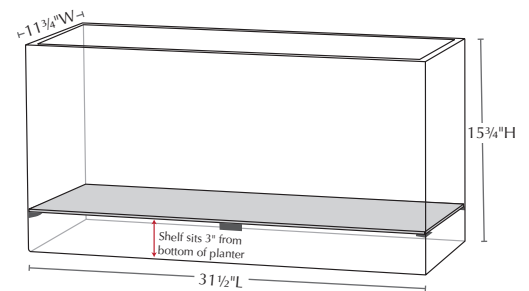
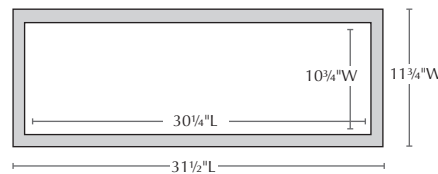
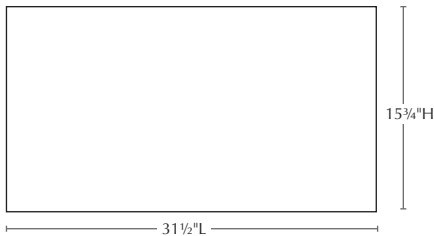
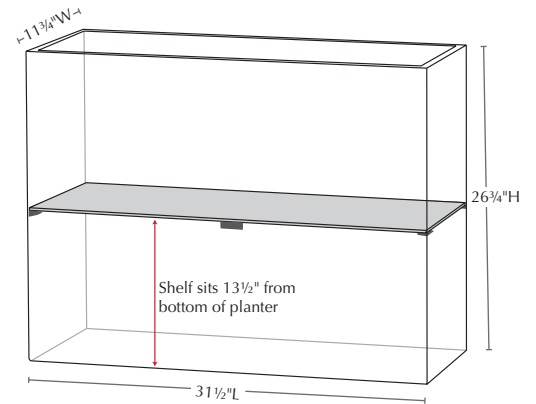

Materials: unsaturated polyester resin, sand, stone powder, talc powder, and fiberglass

Care & Maintenance/Outdoor Planting Instructions: Our fiberglass planters are equipped with pre-installed drainage holes and raised feet to allow for drainage. The drain holes must be kept clear to maintain the longevity of your planter, especially in climates that undergo freeze thaw cycles in the winter. We recommend: Covering the drain holes with a mesh screen or equivalent to keep debris from clogging the openings; Filling the bottom of the planter with non-porous drainage material; Filling the remainder of the planter with a well-draining soil mix that will not retain water; and lastly, covering the soil with decorative mulch or pine bark to the top rim of the planter to discourage water from pooling on the surface. For indoor use, Campania offers a saucer system for the Farnley and Sandal planter series and plugs are available upon request.

Cleaning Instructions: Campania Lite[®] planters can be cleaned with either water or Windex[®] with Ammonia-D. Spray down the surface of the planter where it is dirty and use a lint-free cloth or sponge to wipe the surface. Note that it may take several cycles of wiping and drying before the planter is completely clean. This is normal and to be expected with the texture in the fiberglass. Do not pressure wash, use alcohol based cleaners, apply corrosive cleaners or clean with anything abrasive.

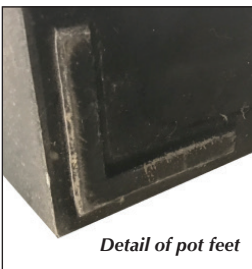

Warranty: Campania International, Inc. provides a limited 3 year warranty for material and manufacturing defects only assuming proper product care and maintenance as described in Campania's product specifications. Please refer to Campania's care instructions for proper care and maintenance. In addition to the failure to properly care for and maintain the product, this limited warranty does not apply to any defects which occur in the color or surface of the product which are the result of natural weathering, exposure to the elements or improper winterization. Campania International, Inc. will not be held liable for any incidental or consequential damages, including but not limited to damage to any plants which may have been planted in the product.