

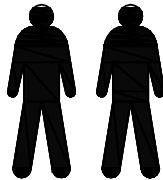

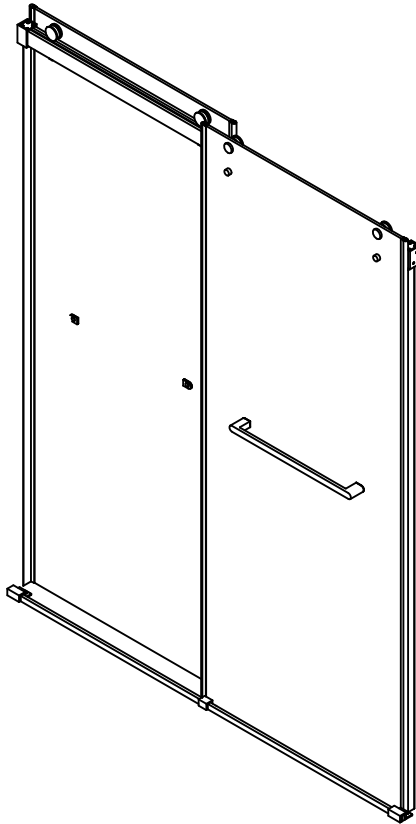

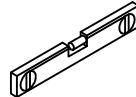



BW-06 Installation Manual

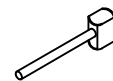

2 PEOPLE REQUIRED

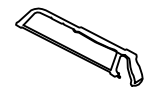
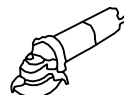
Tool List

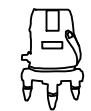







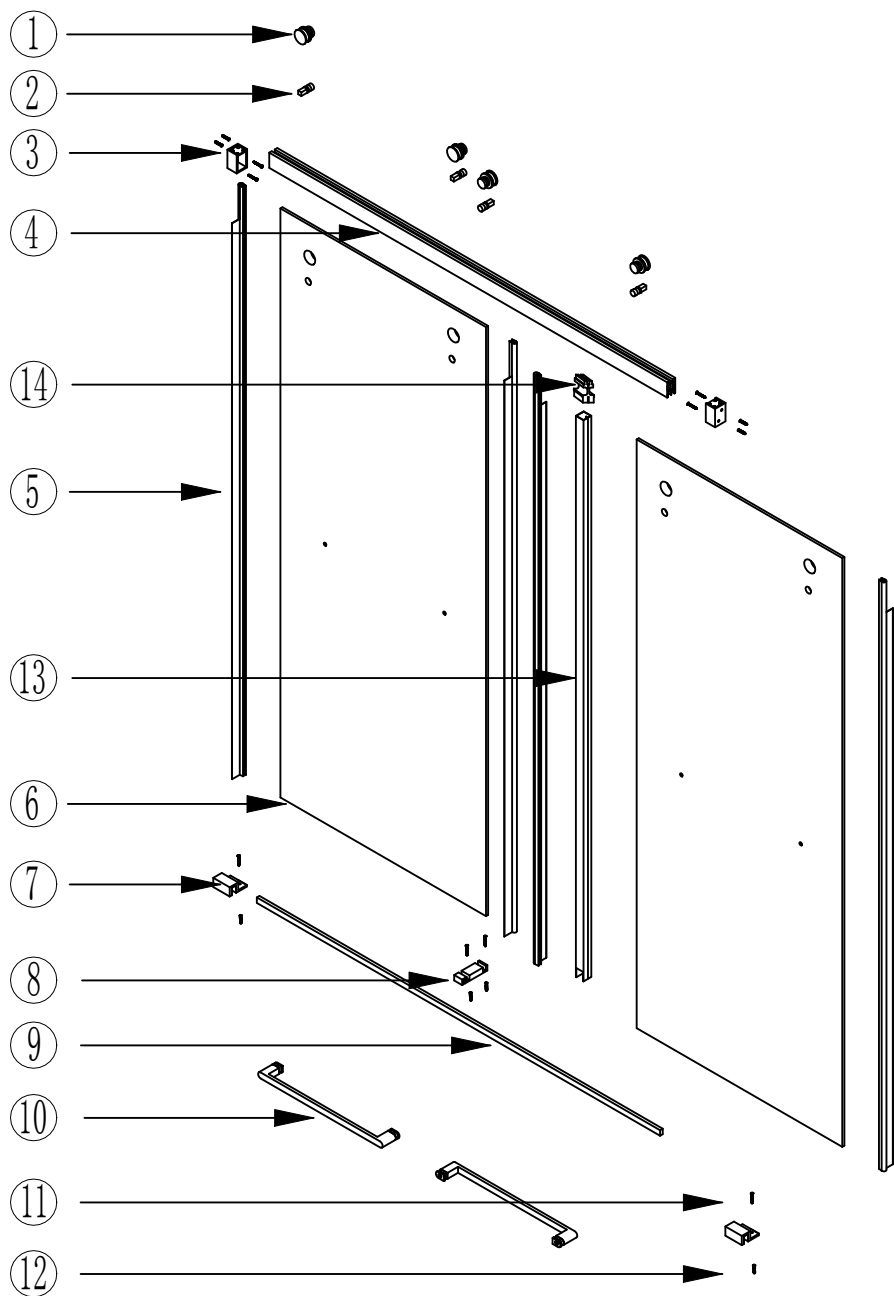





 Spirit level	 Tape measure	 Pencil
 Power drill	 Drill bit	 Rubber hammer
 Silicone Gun	 Screwdriver	 Hacksaw
 Hand grinder	 Safety glass	 Laser level



CAUTION: Risk of injury or product damage.

During installation tempered glass should not come in direct contact with metal parts or it may shatter. Silicone must always be used between glass and metal. Do not touch the edges of tempered glass with tools. Do not attempt to cut tempered glass as it will shatter.



NO.	Picture	Name	Quantity
1		Pulley	4
2		Anti-detachable shaft	4
3		Upper guide rail fixing piece	2
4		Upper guide rail (include 4 sets buffers inside)	1
5		Door side waterproof seal	4
6		Tempered glass	2
7		Lower guide rail fixing piece	2
8		Guide block	1
9		Lower guide rail	1
10		Handle	2
11		Screw	8
12		Expansion rubber particle	8
13		Central column profile	1
14		Central column profile connector	1

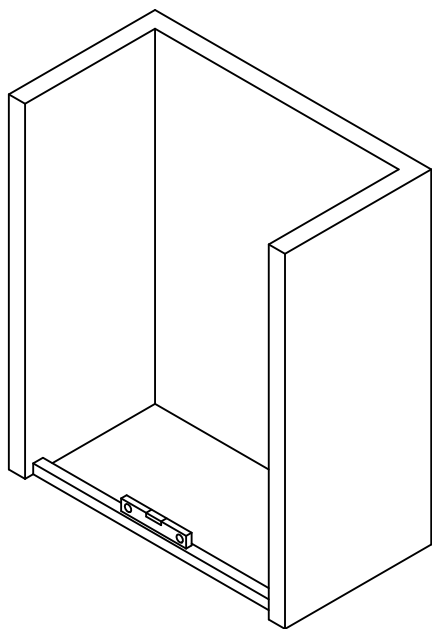

First ,use a level to adjust the base tray.

1

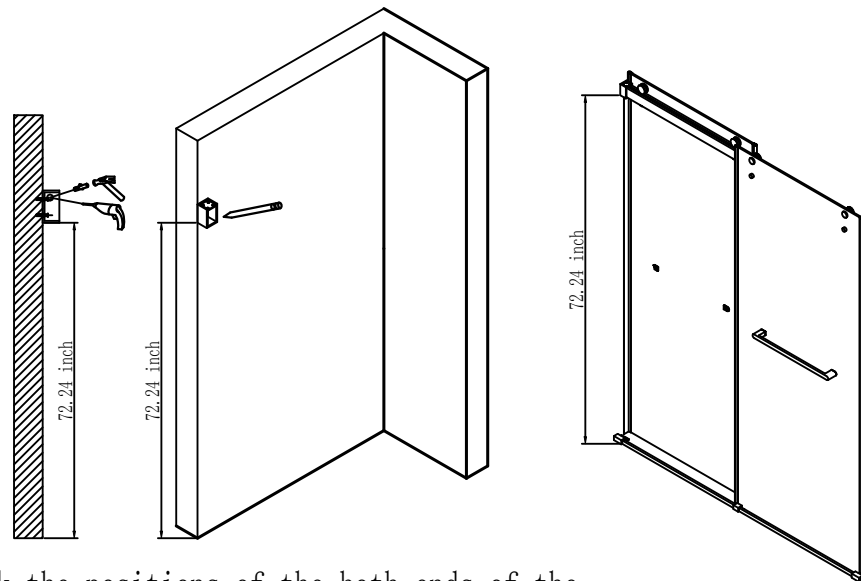

Mark the positions of the both ends of the fixing pieces on the upper guide rail with a pencil (72.24 inch), and then drill holes and fill in expansion rubber particles.

2

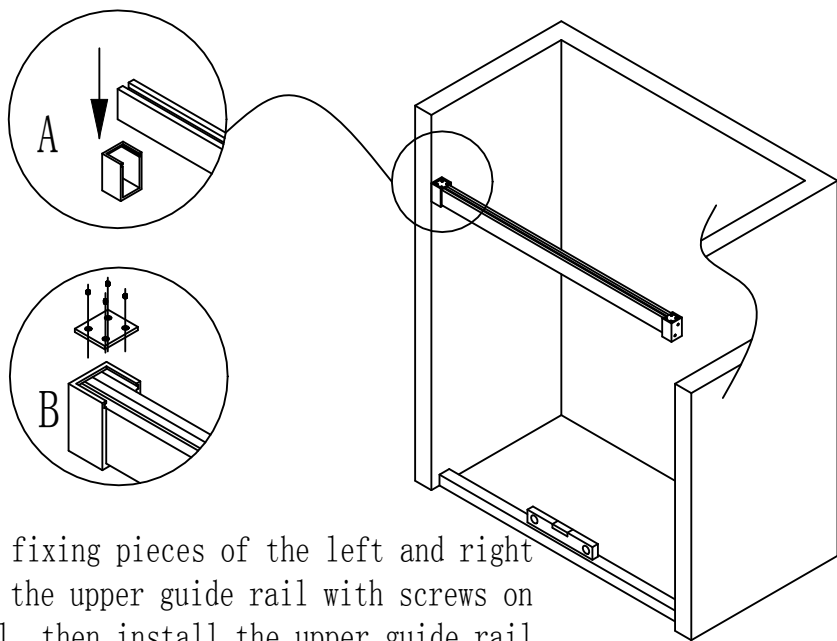

Fix the fixing pieces of the left and right ends of the upper guide rail with screws on the wall, then install the upper guide rail and tighten it with top screws.

3

According to the center and vertical lower part of the upper guide rail, mark the hole positions of the lower guide rail fixing pieces and guide block, then tighten the lower guide rail fixing pieces and guide block with screws.

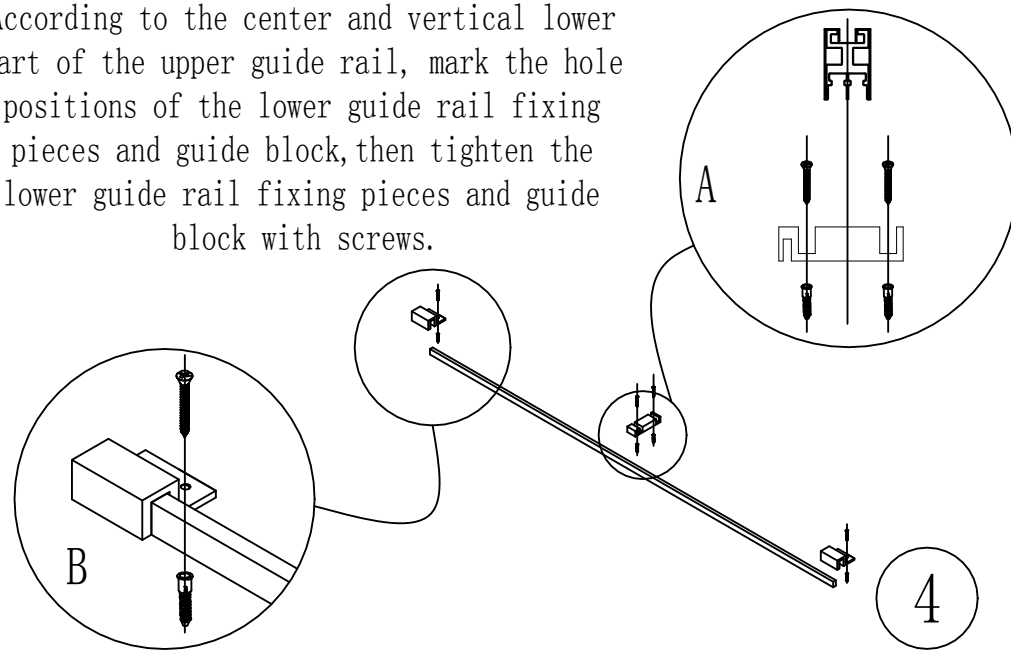

4

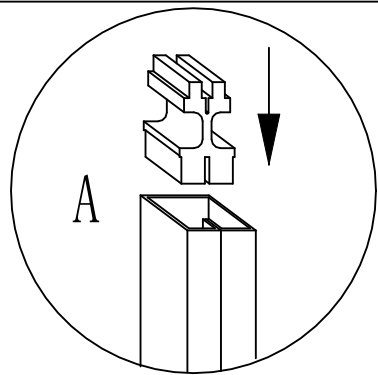

Snap the central column profile connector into the central column profile.

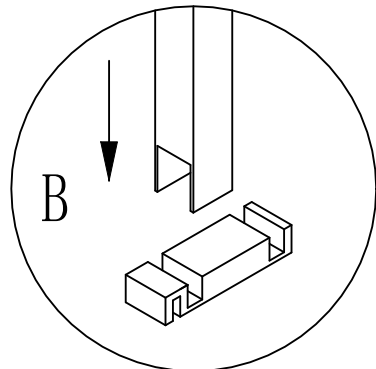

Insert the central column profile into the center of the guide block.

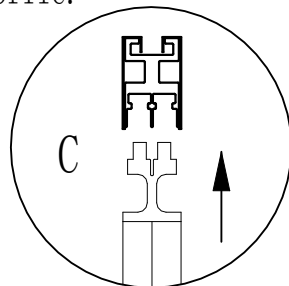

Insert the assembled central column profile into the exact center of the upper guide rail.

5

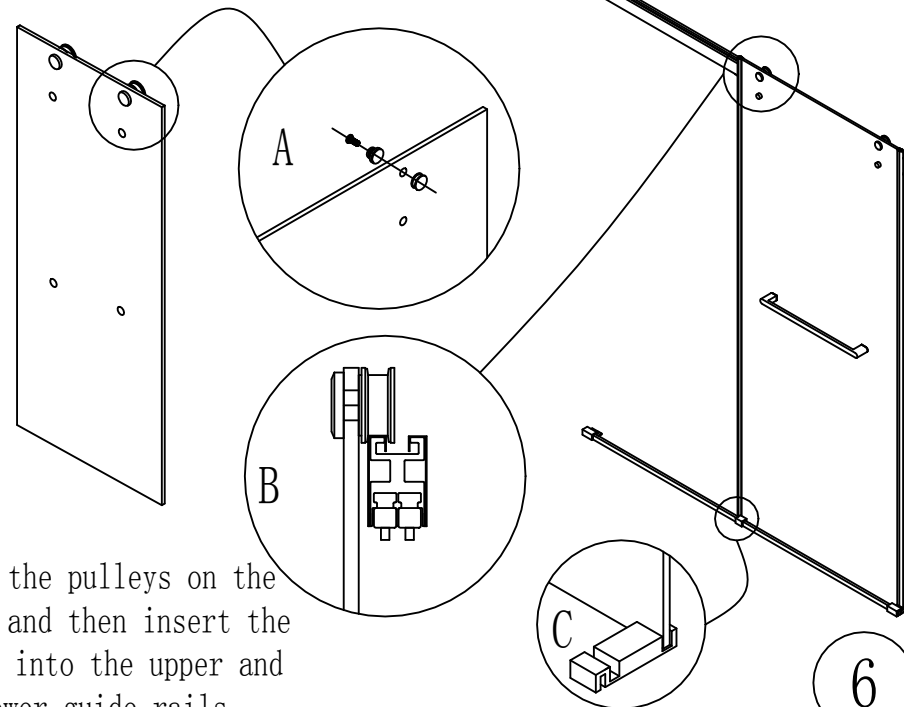

Lock the pulleys on the glass and then insert the glass into the upper and lower guide rails.

6

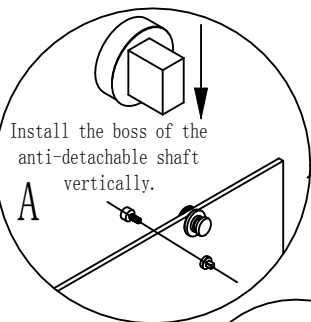

Install the boss of the anti-detachable shaft vertically.

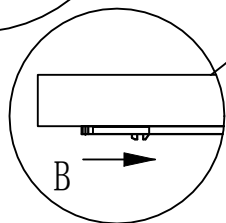

B

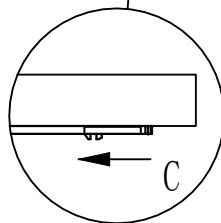

7

After hanging the door glass, install the anti-detachable shaft under the pulley, and rotate the pulley to ensure a tight fitting state between the anti-detachable shaft and the guide rail, adjust the buffers both ends of the guide rail to the open state.

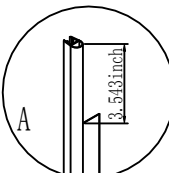
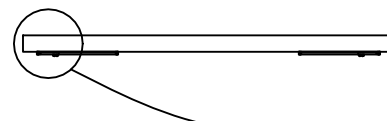

Cut off 3.543inch from the top of the door side waterproof seal, then install it on the door glass.

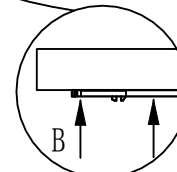

Loosen the screws at both ends of the buffer, move the buffer to keep the door glass and wall in a sealed state.

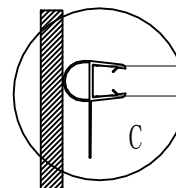

8

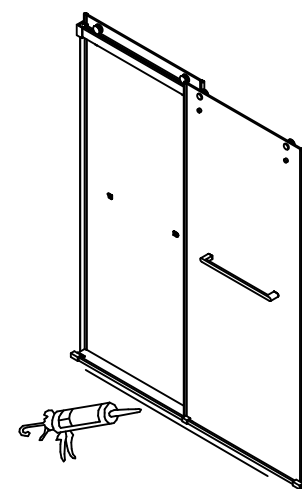

24 HOURS

Install the handles, apply glass glue around the perimeter, and the installation is complete.

9