

INFRARED SAUNA ROOM WITH LED OPERATION INSTRUCTION

3 - Persons Home Sauna



EASYHAWKservice@outlook.com

✉ Our team is available 24/7 to help with any product questions. Contact us anytime!

Product Data

Product Name: Indoor Sauna Room	Main Body dimension: 150x100x185(cm)
Power of use: 110-120V/50-60HZ	Operation temperature/hour: 64~149 ℉ /0~90 minutes
Heater Power: 1750W	Heate: Infrared Carbon Heate
Wood Material: Okoume	MADE IN CHINA

Please prepare below tools before installation. (Not Included)

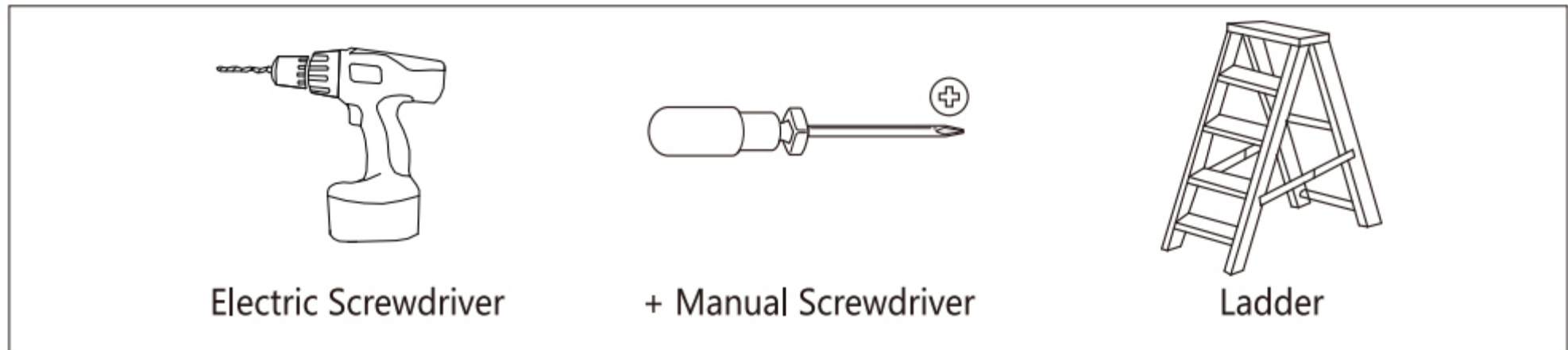

Notice

Thank you for buying our Product!
Please read the following contents before using the Product.



Warnings

1. There are risks of low-temperature burns for sensitive skins, and for blood-flow disorders such as diabetes, blood pressure, heart disease.
Please check your skin conditions frequently whenever you are using it.
(We recommend that you should consult a doctor or an expert.)
2. Please do not use it during sleep, or after drinking.
3. It is strictly prohibited sleeping during the use of the Product as it may be exposed to burns even for healthy men.
4. Please consult an expert before using it, for pregnant women or after taking medicines or surgery.
5. It needs the attention of guardians when used by children or individuals who need protection.
6. It is a dry steamer, and you cannot use it with water inside.
7. Do not use electric devices such as a mobile phone in the sauna as it may cause an explosion.
8. If the interval between use is long, we recommend that you turn off the power and unplug the power cord.
9. It needs the attention that does not allow children or pets to enter the sauna.
Do not use this Product for other purposes other than the sauna.

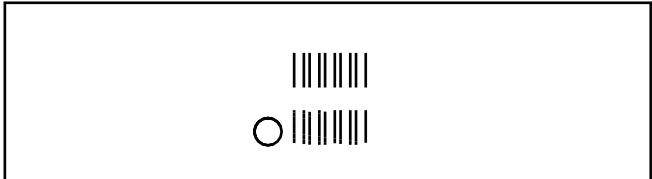

Precautions for return

1. Due to the nature of the Product, you cannot return it after use.
2. If you want to return it after use, then please send it in the same condition as it was.
3. When you return it in cases of necessity, you can claim damages against the broken goods caused during the shipment due to carelessness in packing or against for the missing components/free gifts.
4. In case of losing the box or Styrofoam protector, please return the goods under the guide of staff in the counseling center as the Product may be damaged.

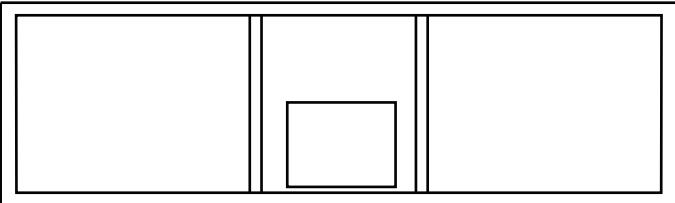
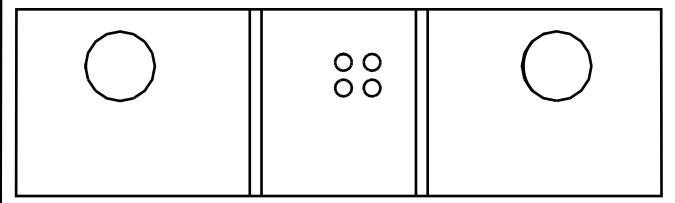
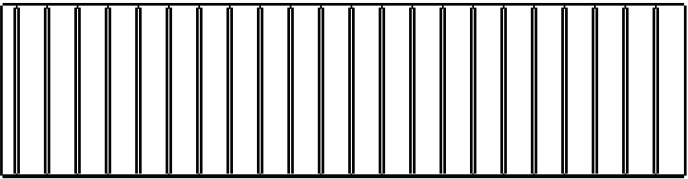
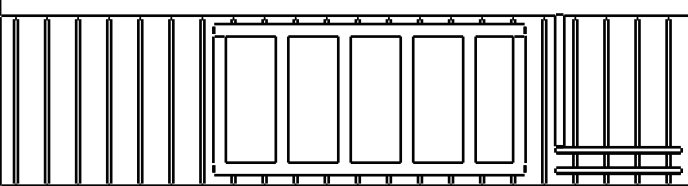
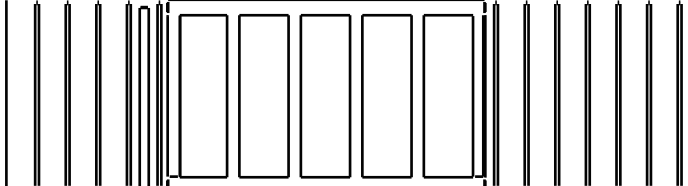
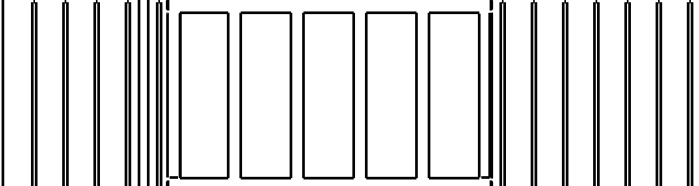
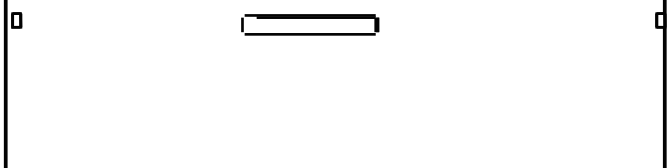
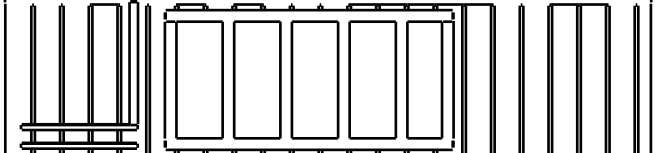

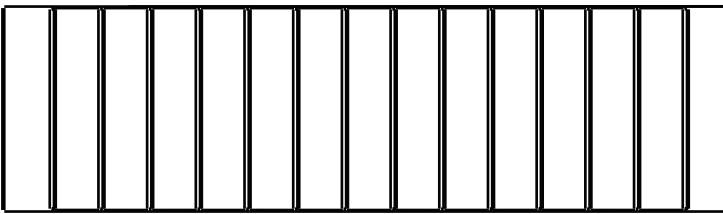
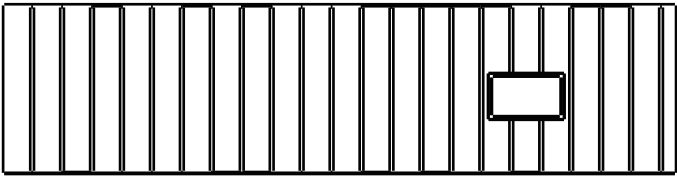
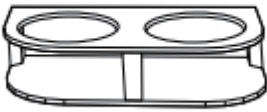

Parts List

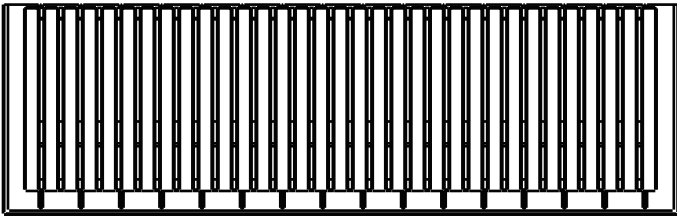
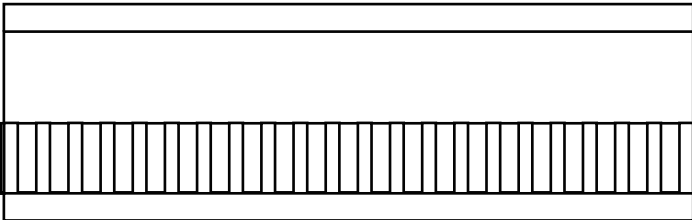
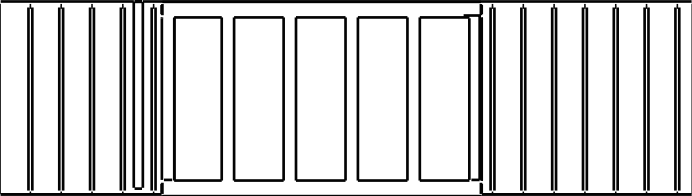
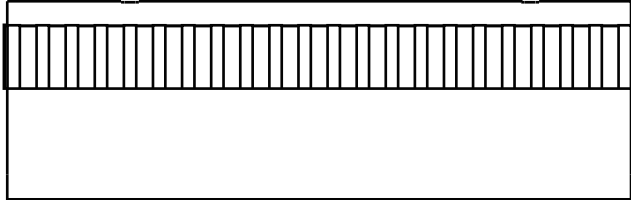
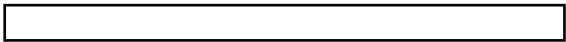
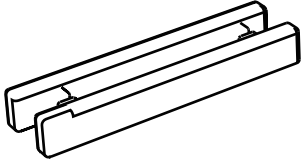
PART	NAME	NO.	QTY.
	DUST-PROOF BOARD I	A	1
	DUST-PROOF BOARD II	B	1
	TOP BOARD I	C	1
	TOP BOARD II	D	1
	LEFT BOARD I	E	1
	LEFT BOARD II	F	1
	BACK BOARD I	G	1
	BACK BOARD II	H	1
	GLASS DOOR	I	1
	RIGHT BOARD I	J	1

Parts List

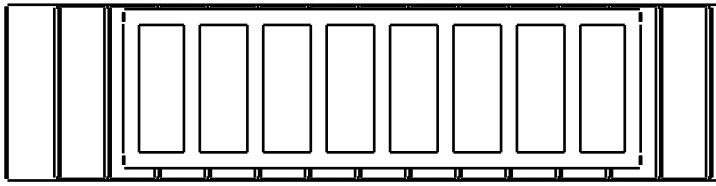
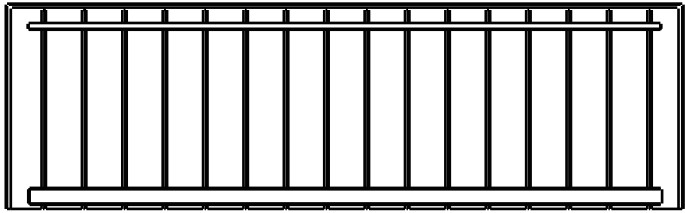
PART	NAME	NO.	QTY.
	BENCH	K	1
	RIGHT BOARD II	L	1
	CUP HOLDER	M	1
	TOWEL HOLDER	N	1
	BOTTOM BOARD I	O	1
	FRONT LEFT BOARD	P	1
	BACK BOARD III	Q	1
	FRONT RIGHT BOARD	R	1
	LED LIGHT STRIP BOARD	S	1
	HANDLE	T	1

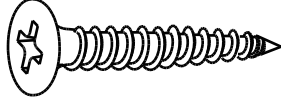
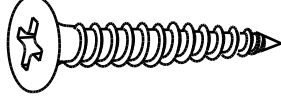
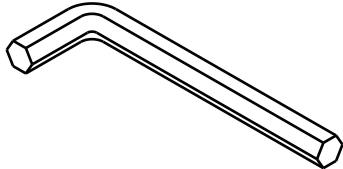
Parts List

PART	NAME	NO.	QTY.
	BENCH FRONT BOARD	U	1
	BOTTOM BOARD II	V	1
	4*14MM Spare Screws For Dust Proof Board	1	5
	4*20MM For Cup Holder	2	5
	4*30MM For Towel Holder	3	5
	4*40MM (1) For RGB Color-Changing LED Strip Wooden Holder (2) For Top Board (3) For Floor Board	4	18
	Hex Screwdriver	5	1
	Screw Hole Sticker		8

Assembly Guide

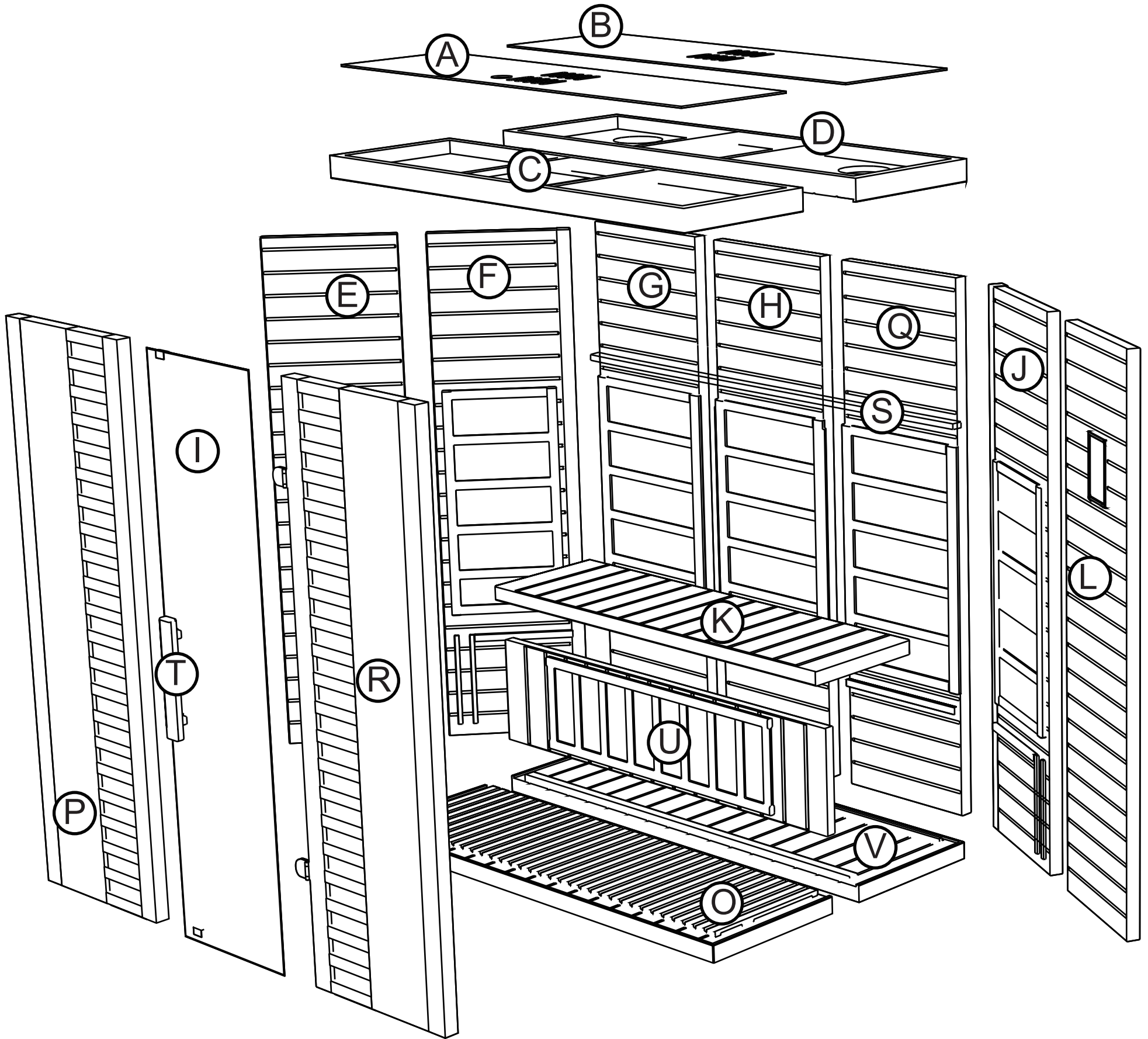

STEP 1

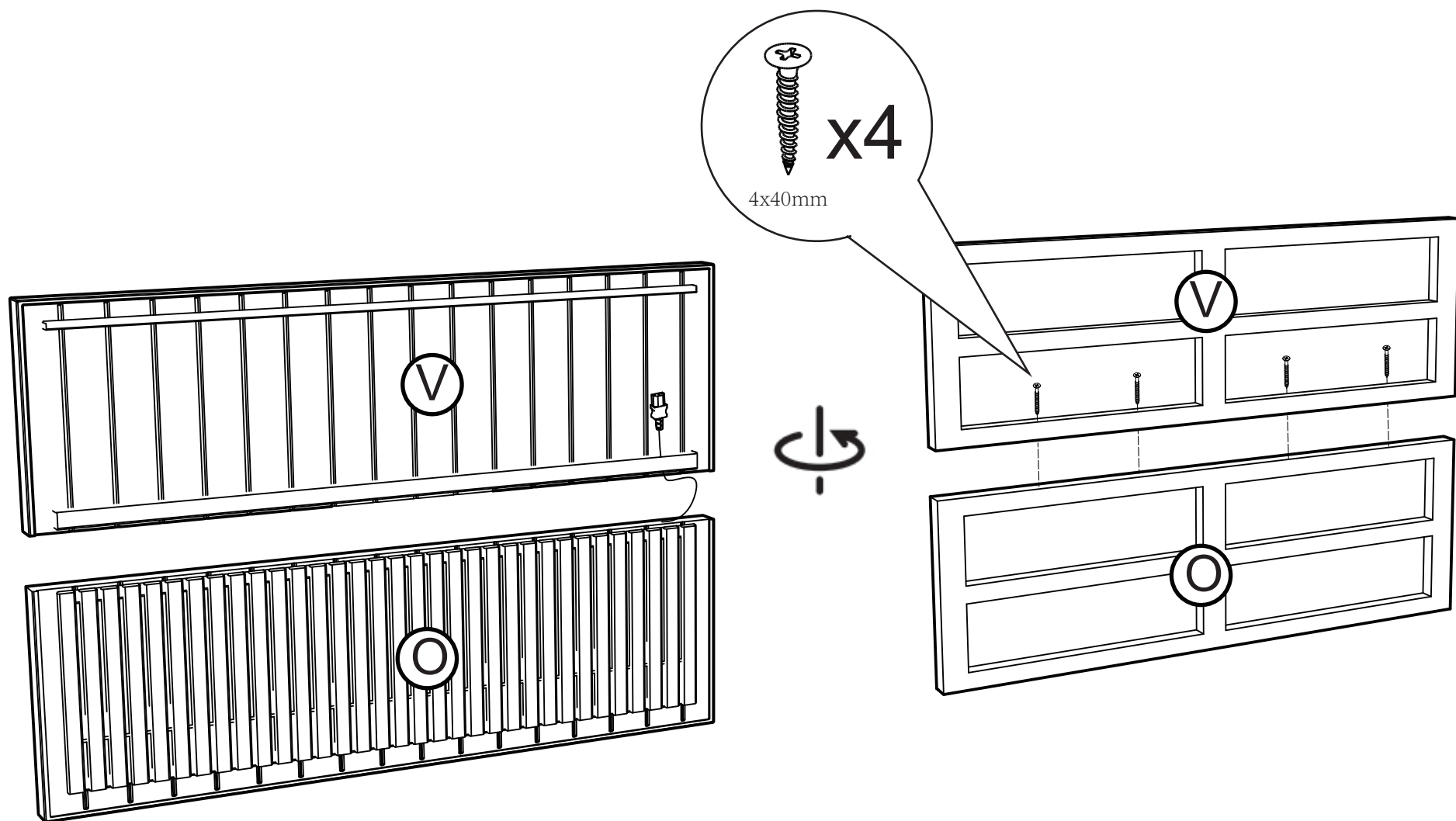

STEP 2

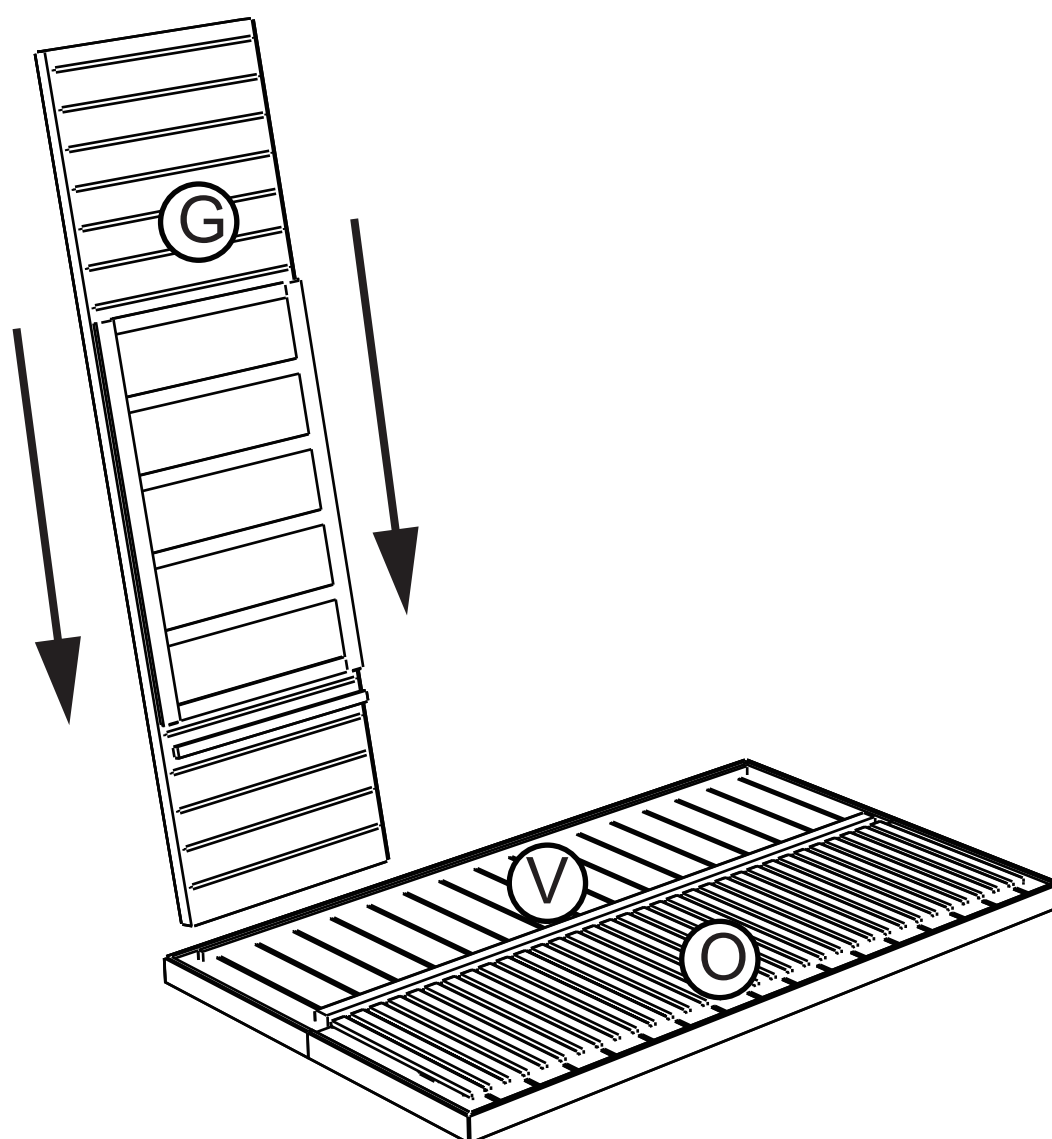

STEP 3

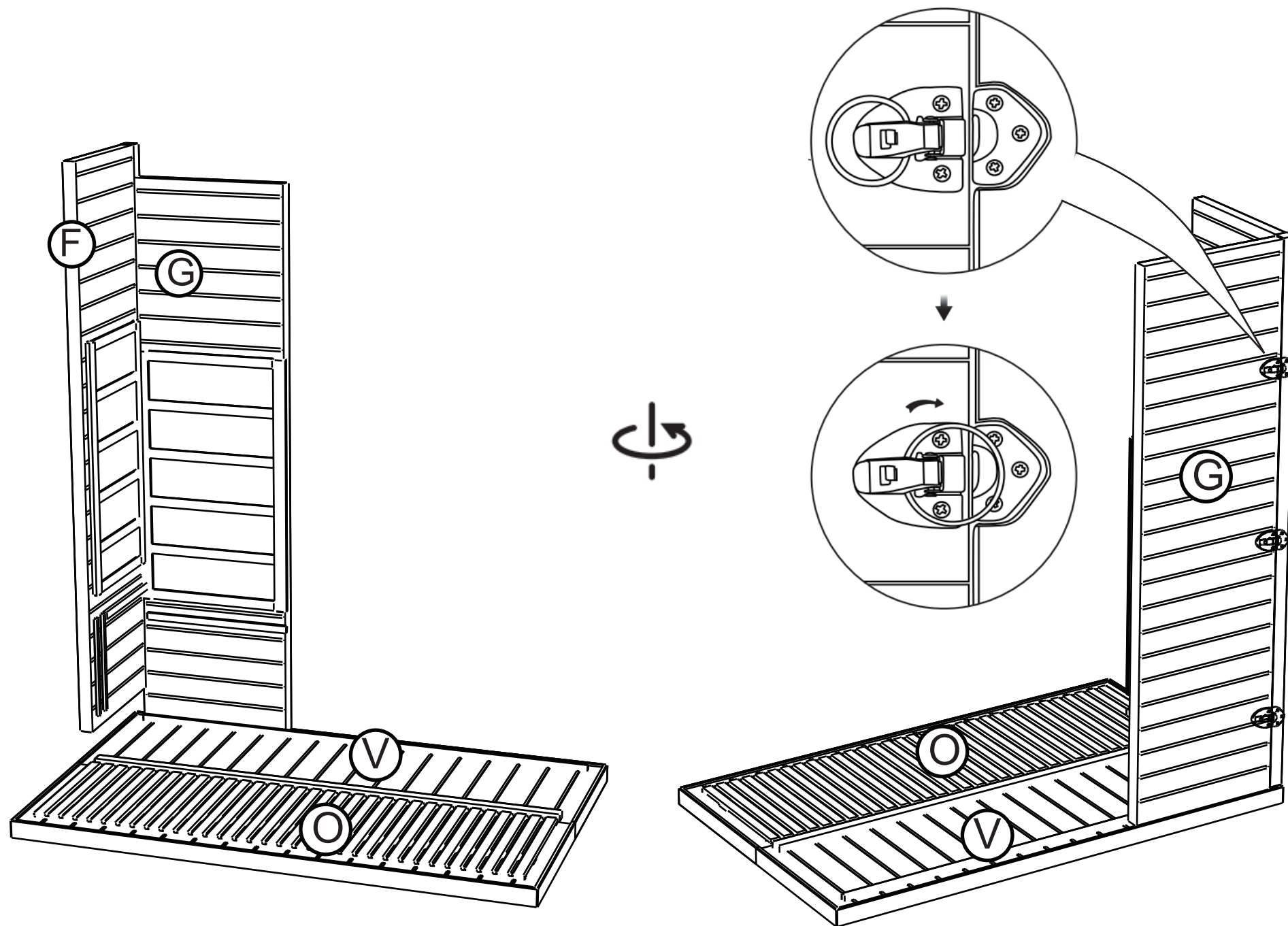

STEP 4

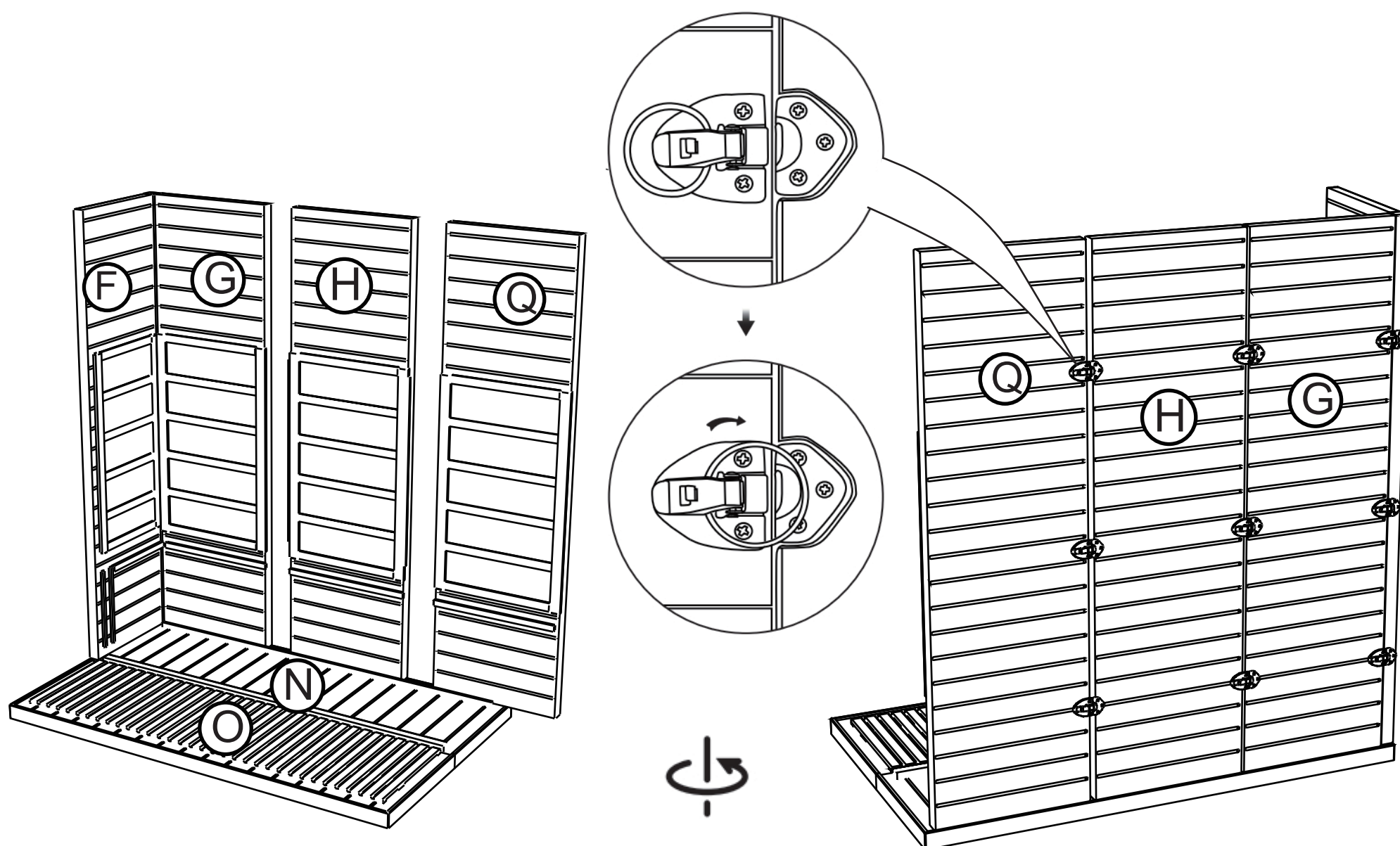

STEP 5

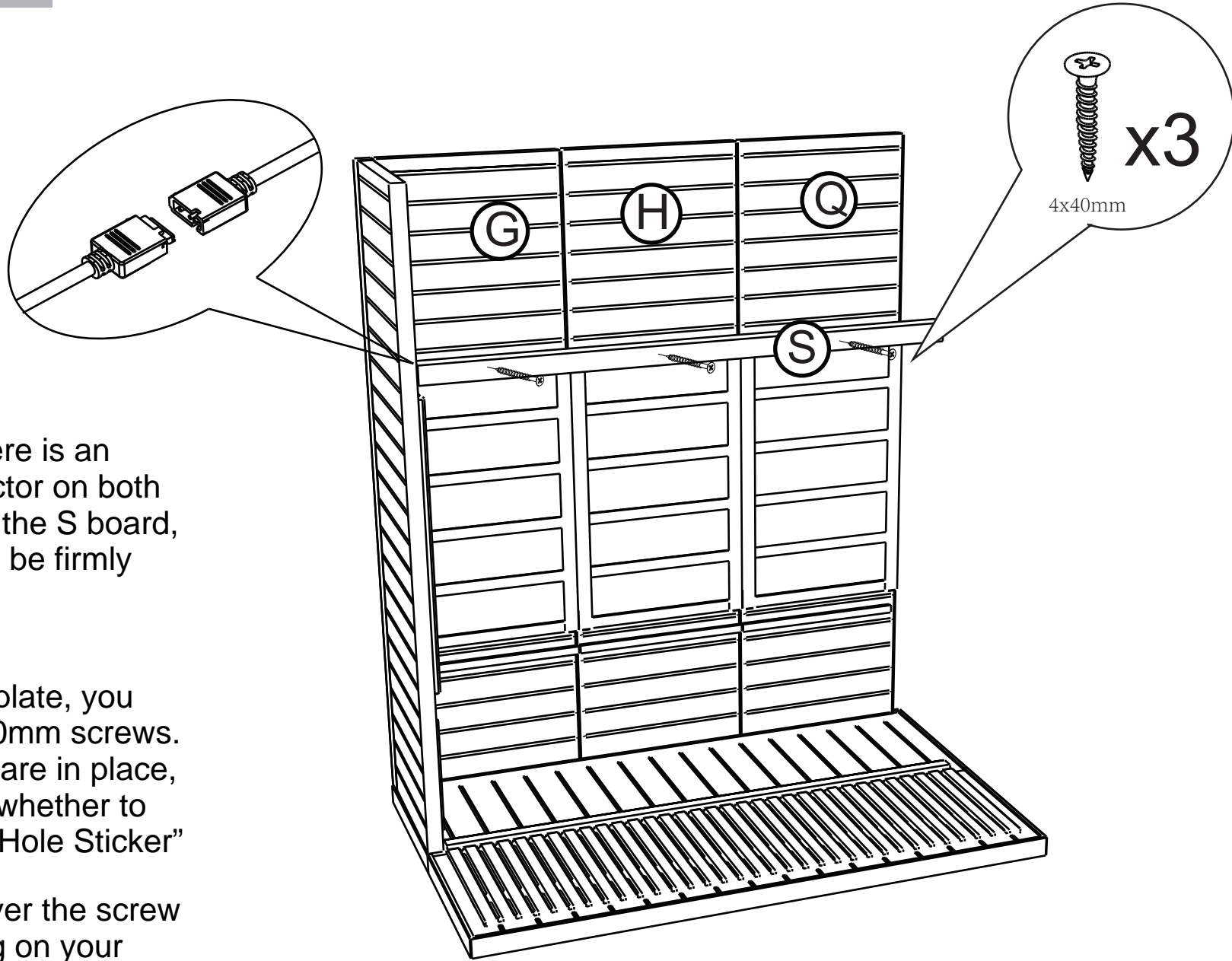

STEP 6

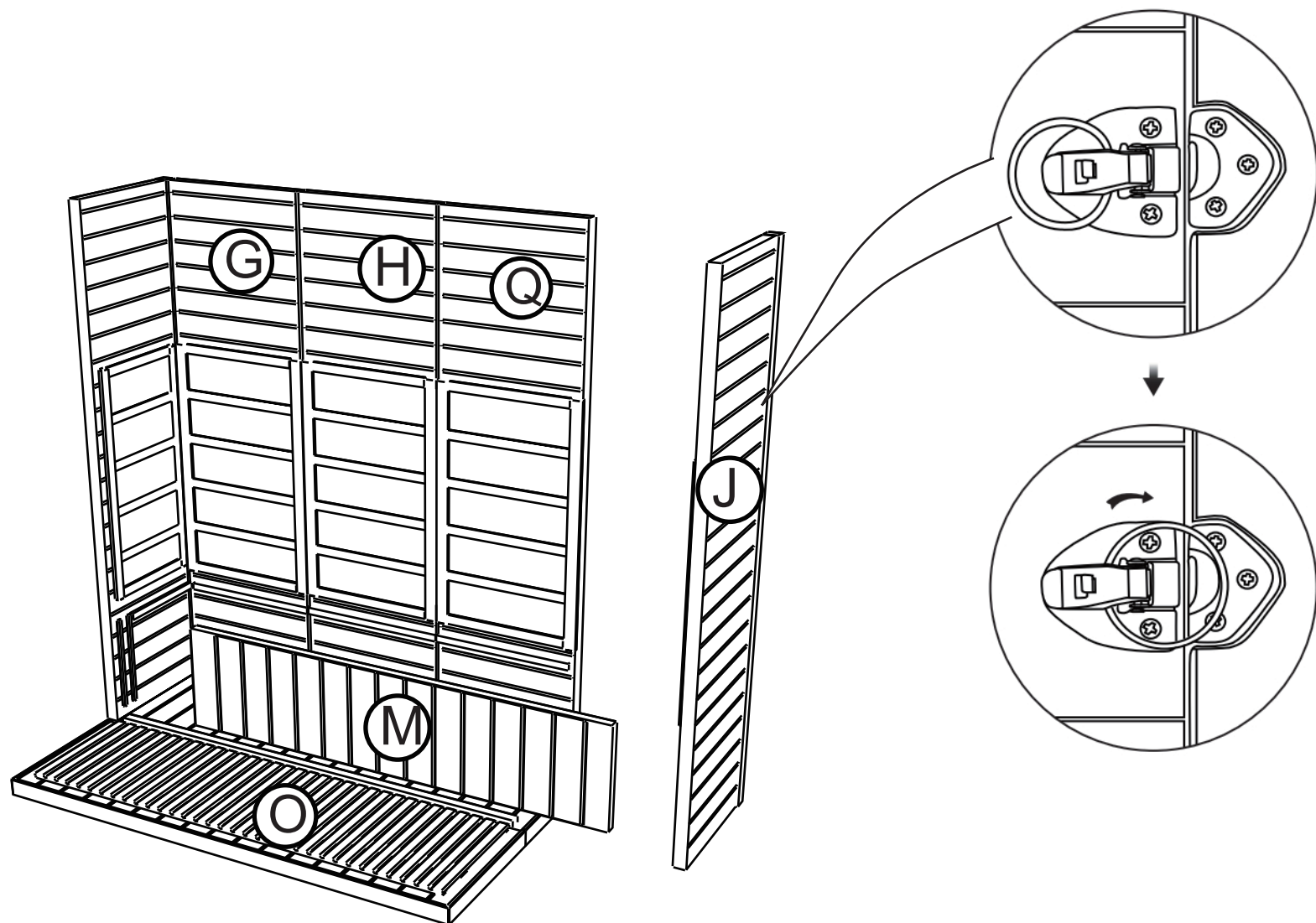

STEP 7

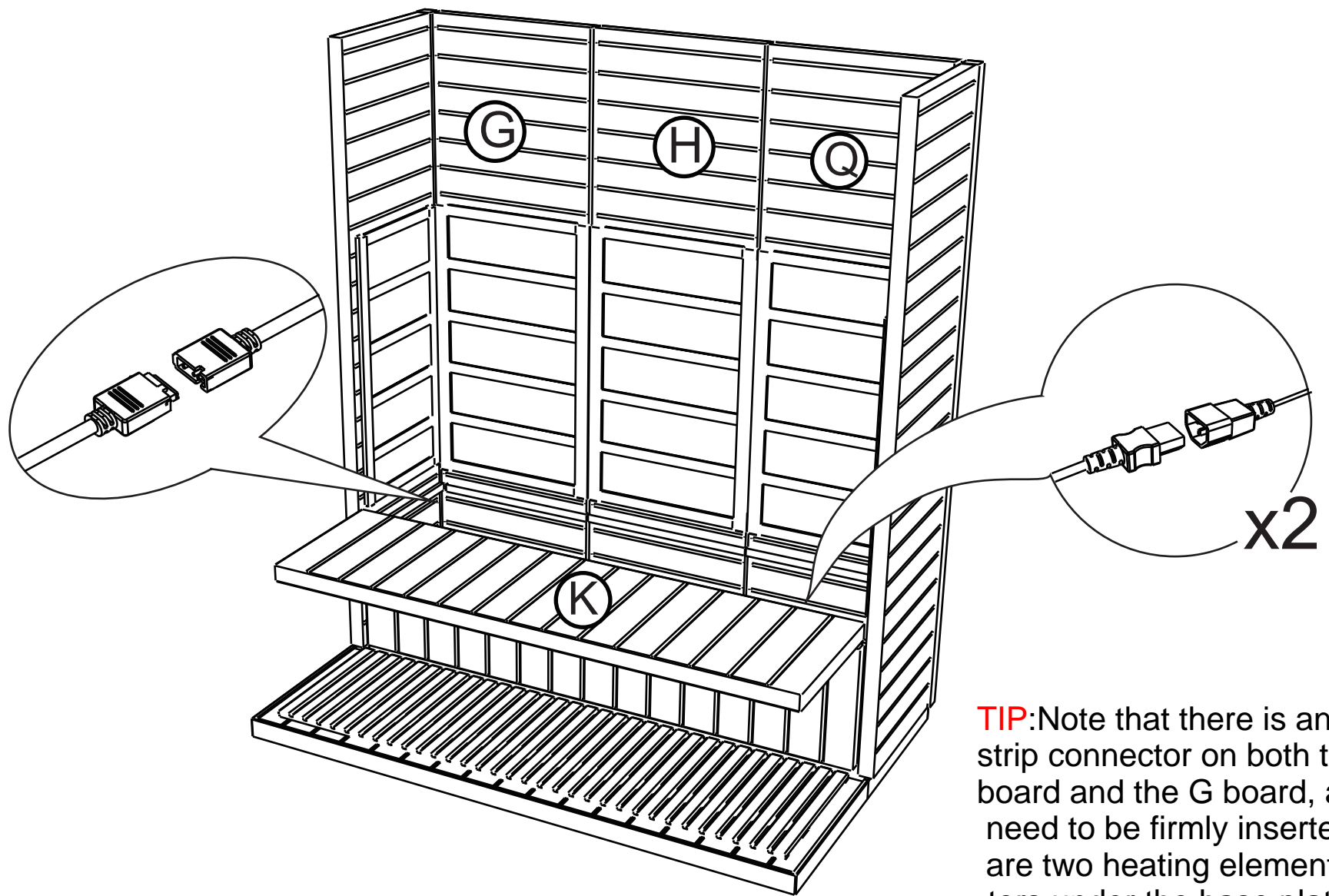

TIP: Note that there is an LED strip connector on both the K board and the G board, and they need to be firmly inserted, There are two heating element connectors under the base plate that need to be firmly inserted.

STEP 8

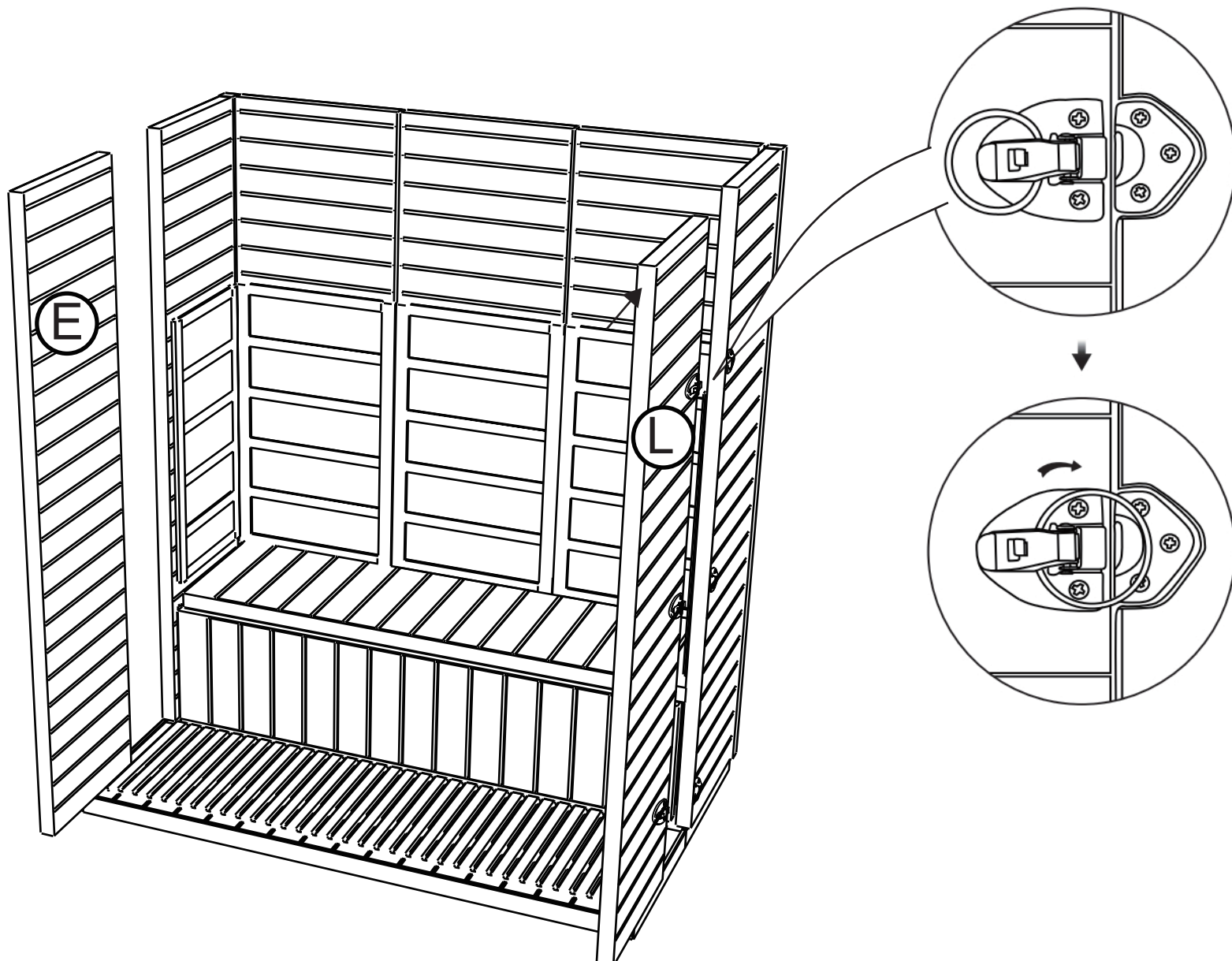

STEP 9

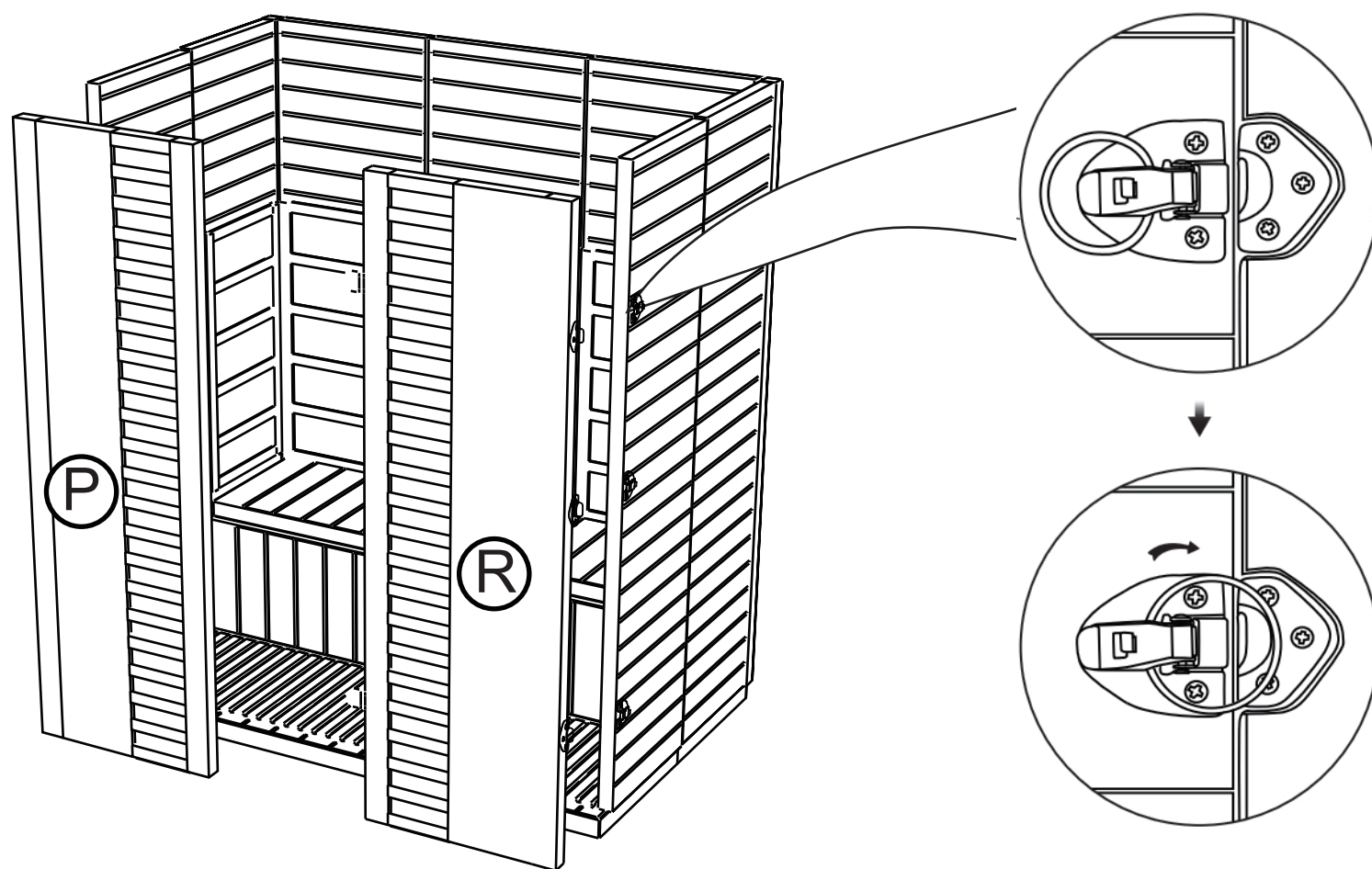

STEP 10

TIP: The DUST-PROOF BOARD comes pre-installed on the top panel with screws. When you receive the product, loosen the screws and remove the DUST-PROOF BOARD.

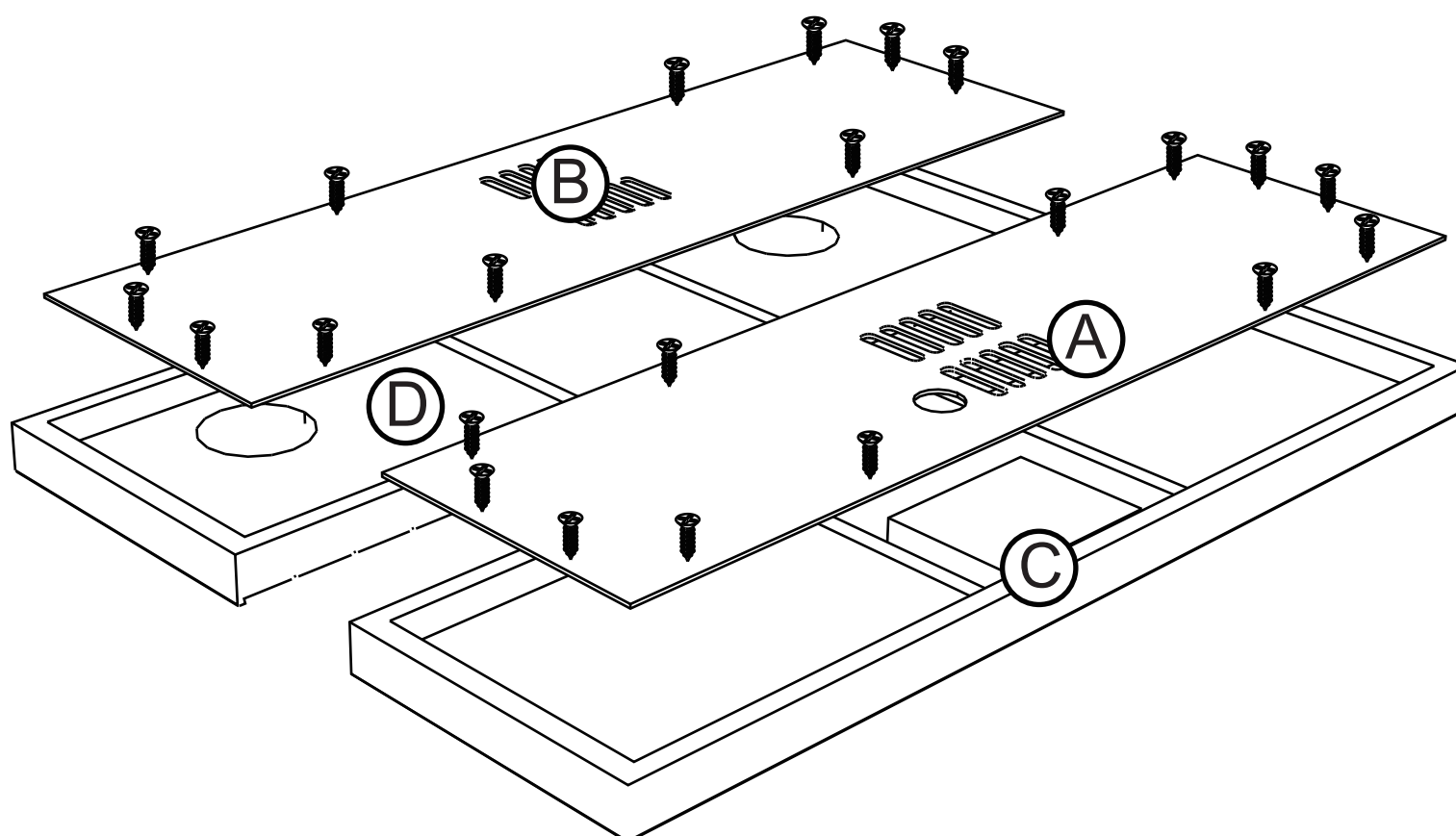

STEP 11

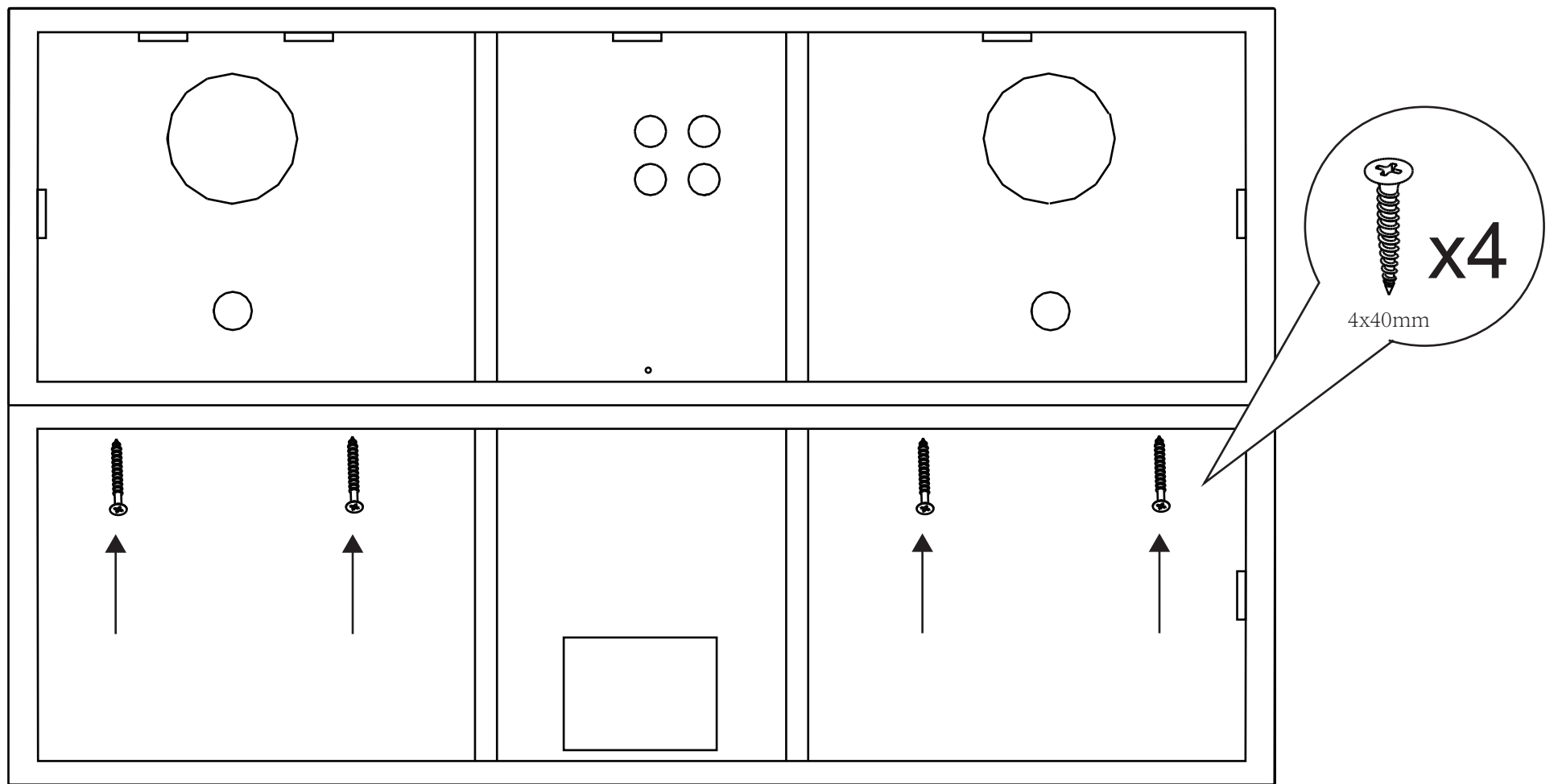

STEP 12

TIP:

Please thread the cable through the cover plate and connect it as shown in the diagram. The diagram shows five black heating element connectors, a white LED strip connector, and a blue network cable connector that need to be threaded upwards onto TOP board.

TIP2:

Insert the TOP board downwards (at the four inner corners of the bottom)

all the way in. If needed, you can use four 4x40mm screws to reinforce the

stability of the top and wall panels from the Top-board (at the four inner corners of the top). Generally, no screws are needed.

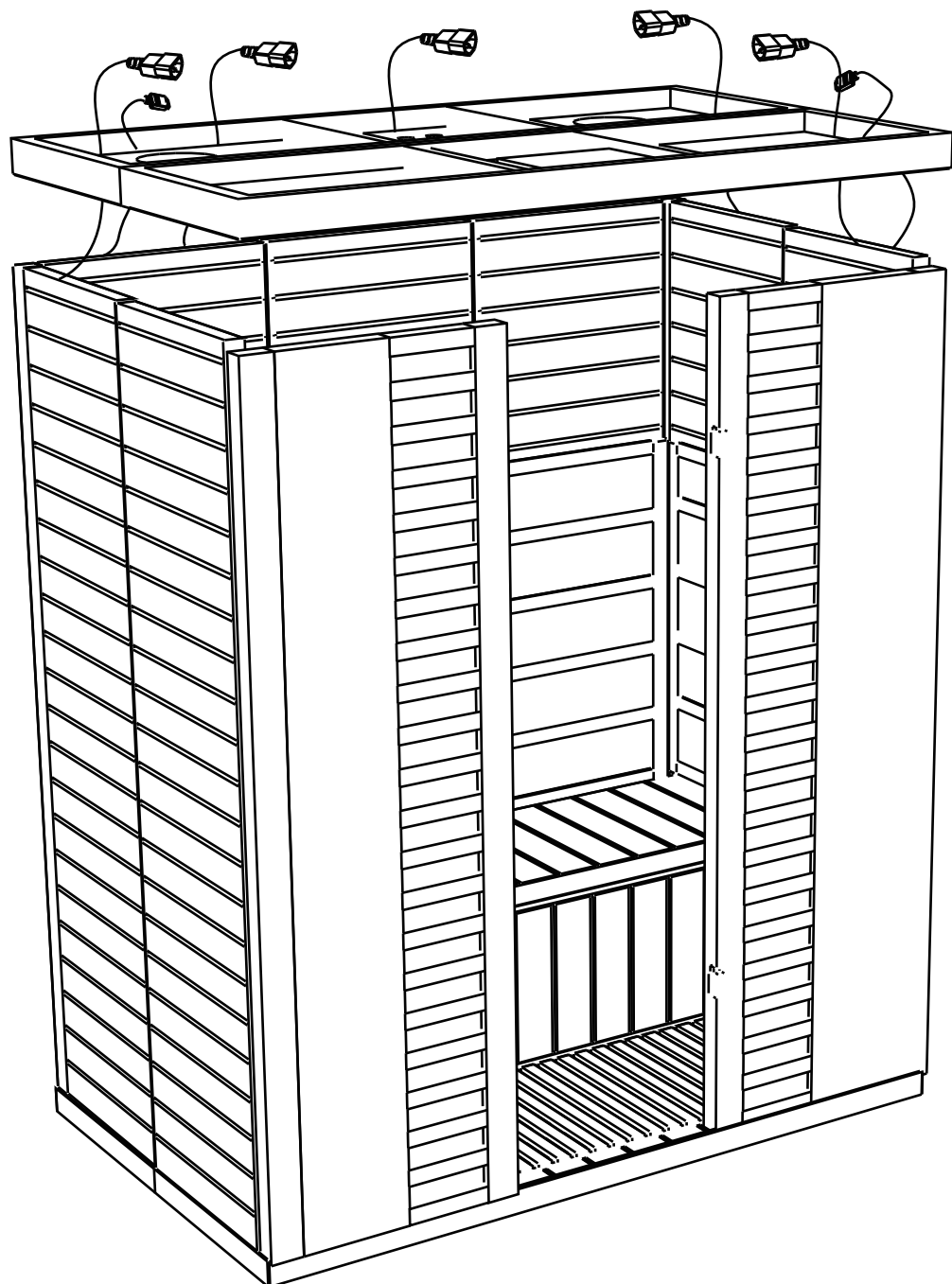

Heating element connector diagram

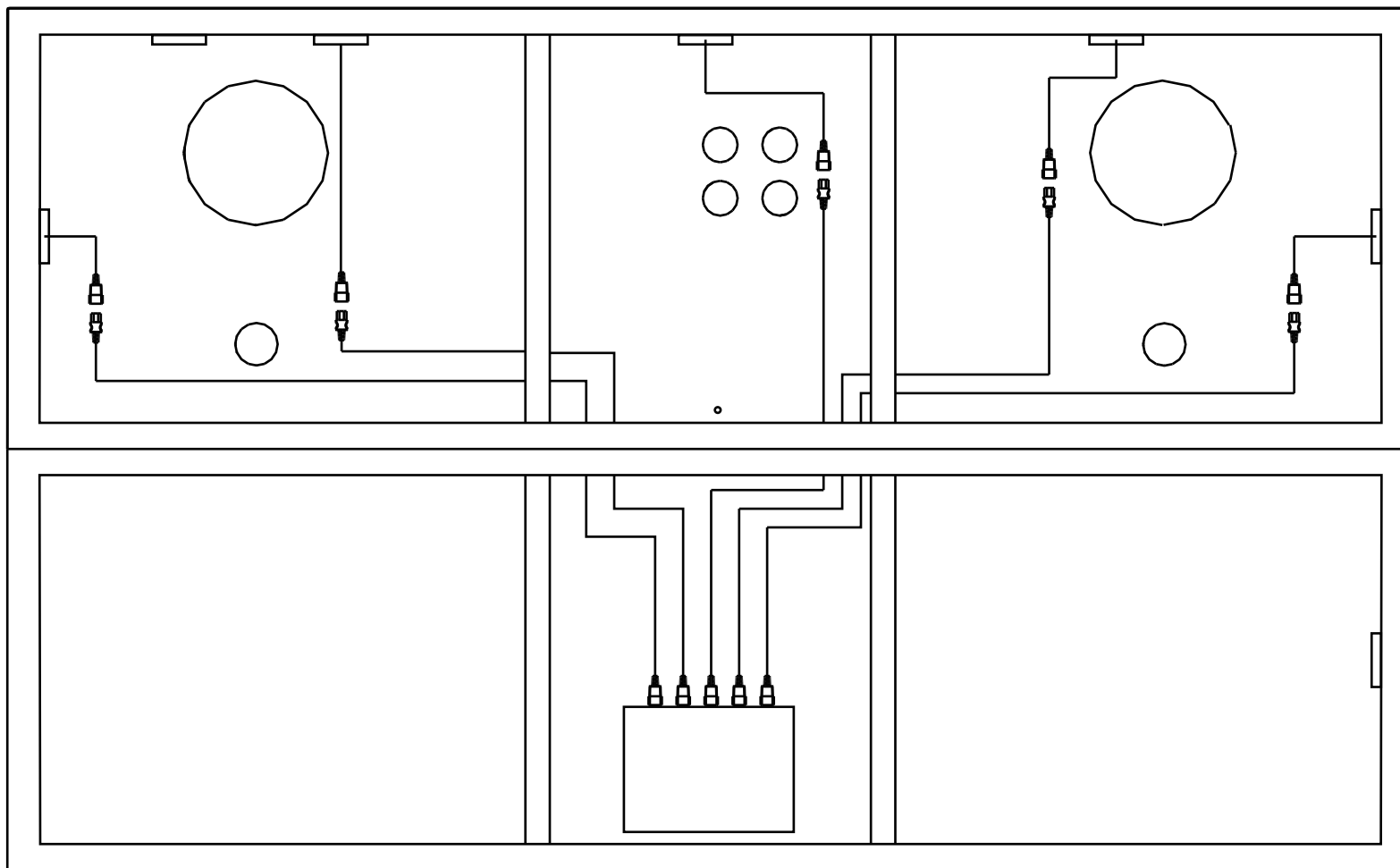

Tip1: Wiring instructions

- ① One end of the LED strip / network cable / thick black heating element connector is already inserted into the controller. You need to find the other end and connect it to the connector.
- ② Speaker wire / reading light wire / temperature control wire – First, locate both connectors and insert them, then insert the other end into the controller. Note: The controller has instructions on connector locations.

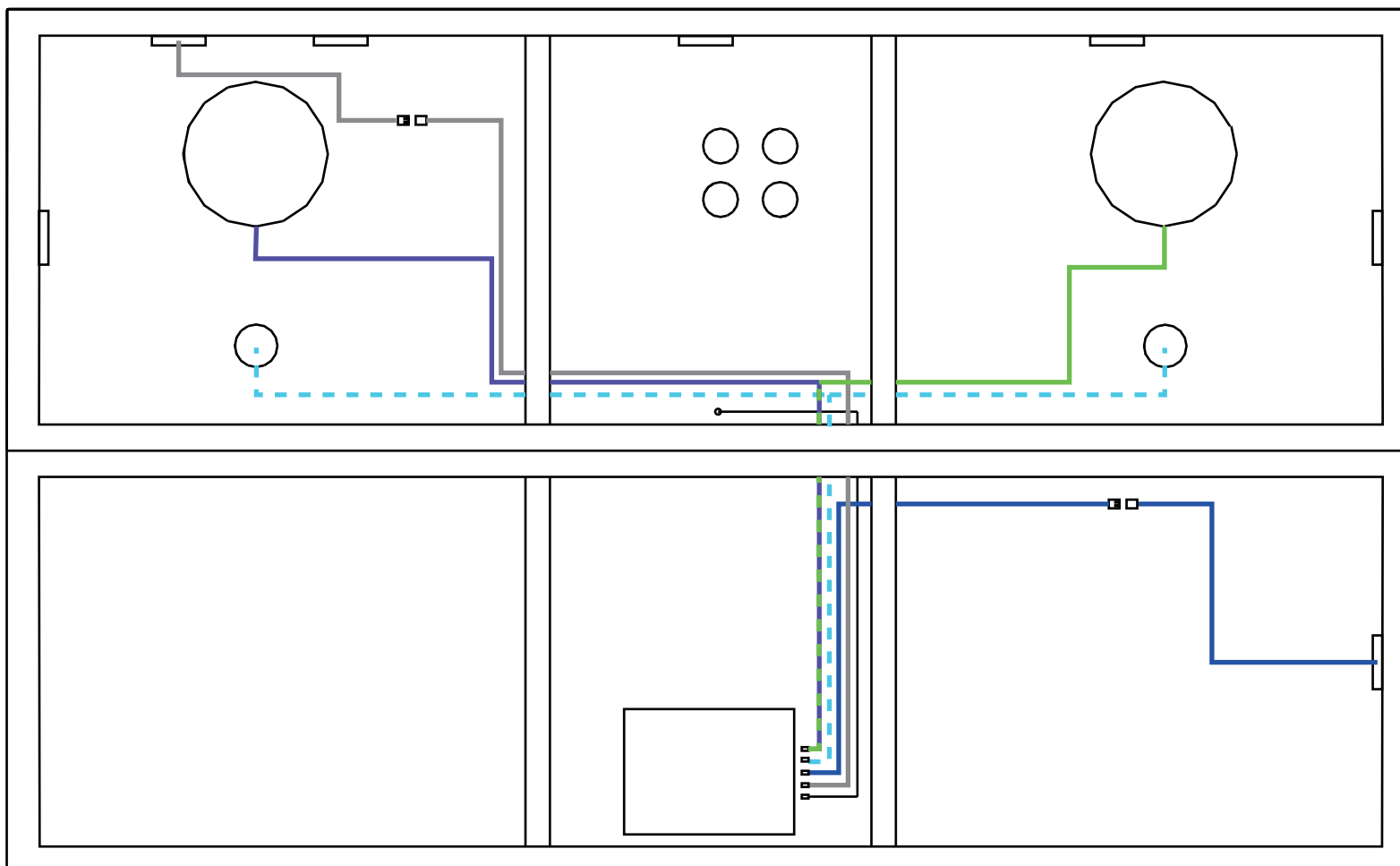

Tip2: Line color description

- ① White-Blue wire - Reading light wiring (4-pin connector) .
- ② Green-Green/Purple-Purple wire - Speaker wiring (6-pin connector) .
- ③ Blue wire - Network cable.
- ④ Pure White wire - LED light strip wiring.
- ⑤ Thin Black wire - Temperature control wiring

STEP 14

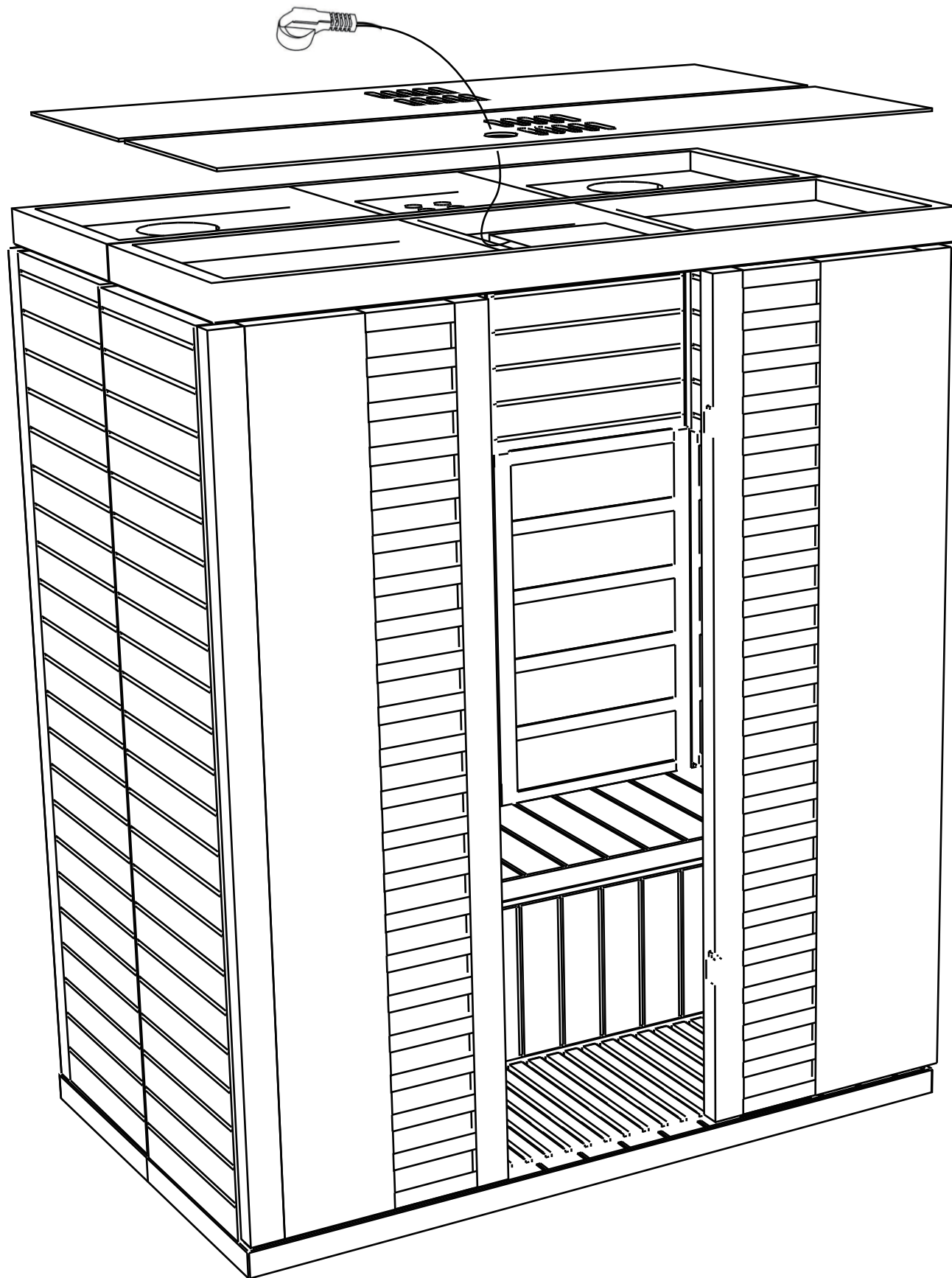

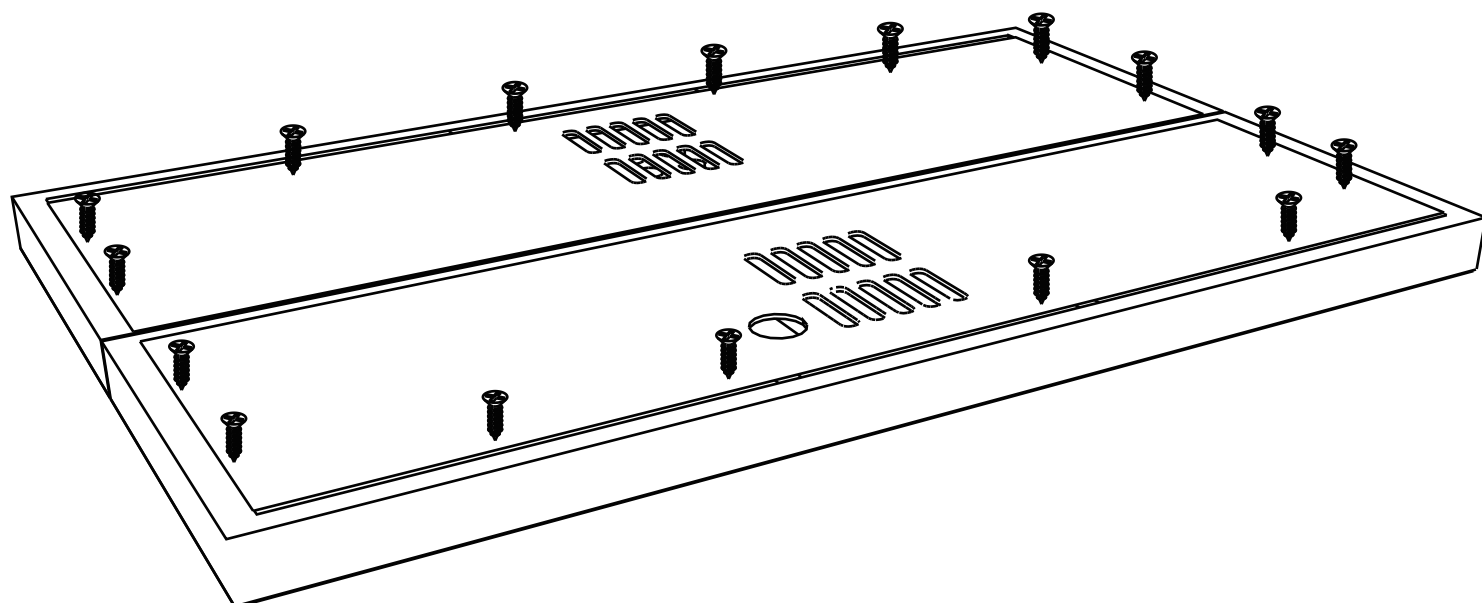

TIP: Check that all cable connections are secure. Once verified, screw the Dust Proof Board back onto the top panel.

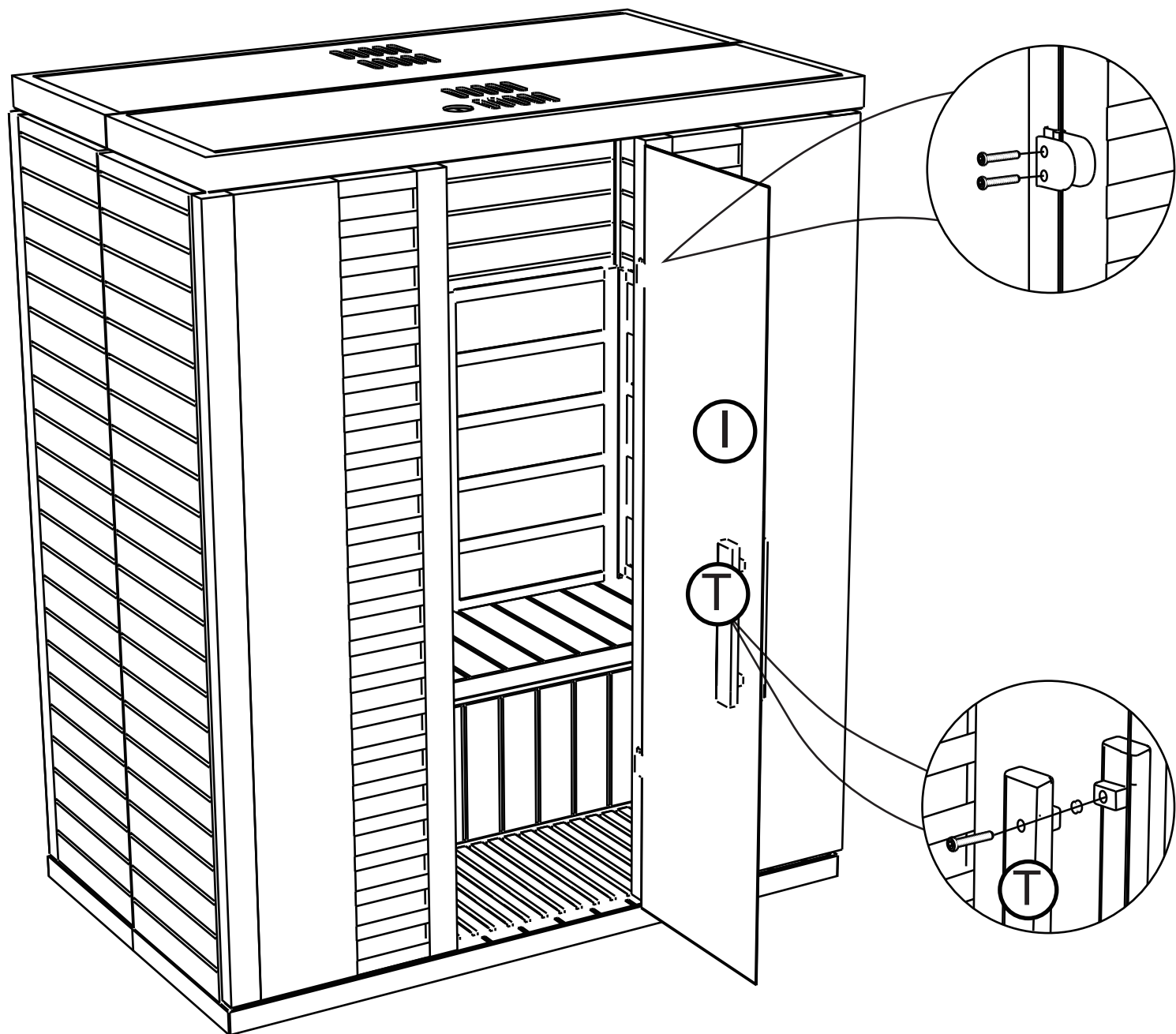

STEP 15

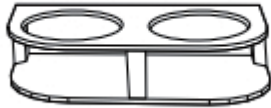

You are free to install the M and N accessories according to your personal preference and where you plan to use them

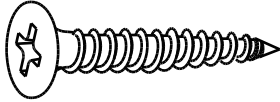
PART	NAME	NO.	QTY.
	Cup holder	M	1
	Towel holder	N	1
	4*20MM For Cup Holder	2	5
	4*30MM For Towel Holder	3	5

Usage of the Product

1. We recommend that you should dress casually.
2. Use the Product after drinking 1 or 2 cups of water or fermented drinks, which may increase the effectiveness.
3. It is recommended to use it after turning on the power and warm it up for about 20 minutes.

Button Type Instrument Panel operation method

Warm tips: before use, all the connecting wires of the controller must be connected.then power on.

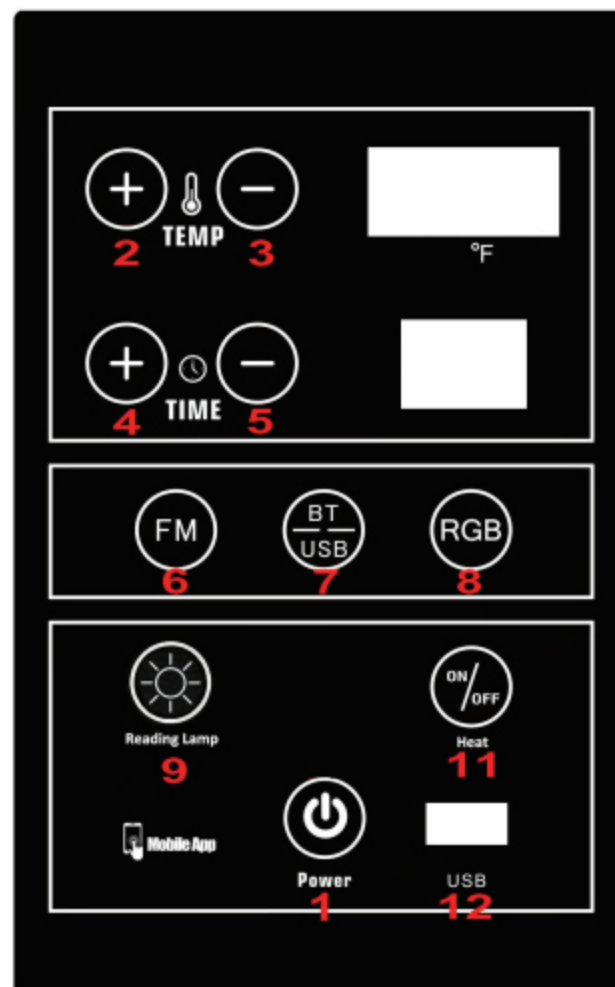

1. Power Button: Switch on and off the machine.
2. .Temperature +/Previous track/Radio upwards search. In the heating mode, press the button to set the temperature up.In the play mode, this button is for previous music. In the radio mode, the button is for upwards channel search.
3. .Temperature -/Next track/Radio downward search. In the heating mode, press the button to set the temperature down. In the play mode, this button is for next music. In the radio mode, this button is for downward channel search.
4. Time +/ volume + button. The heating mode, press the button set the time increase, and the volume is added when playing.
5. .Time -/ volume - button. The heating mode, press the button set the time reduction, and the volume is reduction when playing.
6. Press the FM button to enter the radio mode, and press the "temperature + or -" button to search the channel for 5 seconds. This opportunity will jump to the heating mode automatically.
7. Bluetooth/USB function button: short press to enter bluetooth mode. Search 'Sauna BT' in your mobile bluetooth then connect and play mobile music. Long press this button to enter USB model, insert U disk to play MP3 music.
8. RGB button: press this button to turn on the RGB phototherapy light(Colored Star Lights Or Colored Light Belt or Colored Phototherapy Lamp). Press 1-7 times to select the color of the phototherapy light, press the 8th button to turn off the interior phototherapy light, and press the 9th button to enter the color auto cycle model.
9. Turn on the internal reading lamp and then turn it off.

10. Press to turn on/off the Heater(or Sauna Stove) function.
11. The USB interface, to insert USB disk.
12. WIFI function: WIFI function is a remote APP control function. Download the "Smart Life APP" in the mobile application market. After downloading, make sure to turn on the Bluetooth and Wifi functions of the mobile phone to be connected before connecting the APP. The host control panel remains powered on and in standby mode. Open the "Smart Life APP" on the mobile phone and click Add Device (the device will pop up automatically after opening the APP when the network is good). The device name is: "SAUNAPRO" . After searching, click Connect and enter the 2.4G Wifi account and password to connect (Wifi signal only supports 2.4G network). After connecting, it will automatically jump to the control interface, and you can remotely control the machine's power on and off, temperature, working time settings, lighting settings, and timed power on and off. (If the device cannot be found, press and hold the power button for 5 seconds to reset the device, and then search again) The indicator light will light up after connecting to WIFI.



Smart Life APP

Safety Precautions

What are low-temperature burns?

The Low-temperature burns are not burns caused by high fever, high temperature, but burns that caused by a long period of exposure to heating elements higher than body temperature or exposure to red spots and blisters occurred when contacting with skin. It requires special attention as they occurred without being accompanied by subjective symptoms.

User Cautionary Obligations for protection of low-temperature burns

1. If you have diabetes, heart disease, or high blood pressure, please consult an expert as they are parts of risk patients for the low-temperature burns.
In cases of the necessity for use, check your foot conditions every 10 minutes during use, and prohibits direct contact with ceramic balls of the floor or the inside wall of the container.
2. Even for healthy men, please check the foot skin conditions every 30 minutes, and stop using it immediately if there is anything wrong.
3. It is strictly prohibited sleeping during the use of the Product. It may be exposed to low-temperature burns.
4. It prohibits the use of the Product for pregnant women, physically challenged persons, drinkers, drug users, or after surgery.
5. Do not use when you have a cold, body aches, menstruation, and high body temperature.
6. Please stop using it when you feel it too hot.

Precautions for handling

1. As this Product is electrical appliances of solid wood, it is prohibited to contact any liquids, including water, prohibited to use in wet places, wet floors, or bathrooms.
2. Unplug the power plug and keep the product by covering it with a towel after use.
3. Please be careful not to allow the children or pets to contact it.





Cleaning and management of the Product

Cleaning of the Product

1. If water is injected into the inside container, wipe it with a dry towel and dry it.
2. Please use a vacuum cleaner when removing the foreign substances.
3. It prohibits the use of the bleach, dyes, and paint.
4. It is strictly prohibited disassembly of the Product as it cannot guarantee safety.

Current management of the Product

1. Press the button on the instrument panel slightly. The power is not switched on if you press down the button.
2. Be sure to unplug and remove the power plug after use.
3. Do not use wet towels because it is an electrical Product. There may be a risk of electric shock.
4. Please contact a qualified person or Service center if the power cord is damaged.
5. Do not arbitrarily disassemble, repair, or modify the Product. There may be risks of fire and electric shock.

 <p>Prohibition of the use other than 110-120V</p>	<p>Do not use the voltage other than the alternate current of 110-120V.</p>	 <p>Prohibition of use in wet places</p>	<p>Do not use it when you wash or in a bathhouse.</p>
 <p>Plug Turn off</p>	<p>Be sure to unplug the power plug when you need to repair it.</p>	 <p>Provide AS services</p>	<p>Request an expert or AS center when you replace a power cord.</p>

-Please never disassemble, repair, or modify the Product other than by our installation engineer or repairing technician.

* It may cause fire or electric shock or cause injury due to abnormal operation.

-If used in conjunction with other instruments, there may be a risk of ignition due to abnormal generated heat caused by overloading.

-If used in a place where you can wash or in wet areas, it may cause fire and electrical shock.