

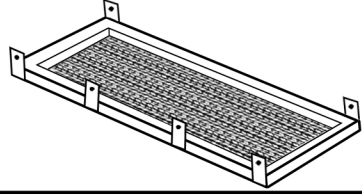

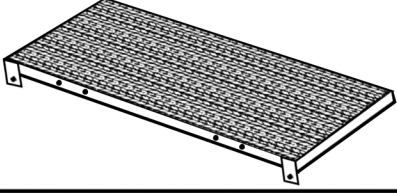
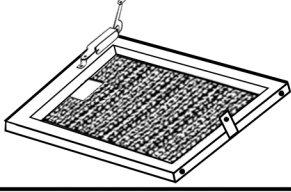
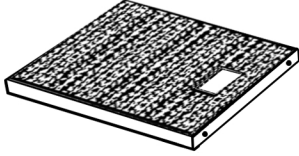
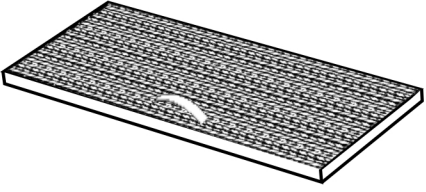
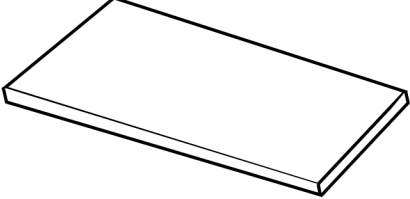

ASSEMBLY INSTRUCTIONS
WATER HYACINTH K/D TRUNK
PRODUCT#: CS5668 / CFV2696NAT
TWO PERSONS ASSEMBLY IS REQUIRED

PART LIST	FIGURE	QUANTITY	DESCRIPTION
A		1 PC	FRONT TRUNK FRAME
A1		1 PC	BACK TRUNK FRAME
B		1 PC	LEFT SIDE TRUNK FRAME
B1		1 PC	RIGHT SIDE TRUNK FRAME
C		1 PC	LID
D		1 PC	BOTTOM PANEL
E		12 PCS	BOLTS FOR LID & TRUNK FRAMES
F		2 PCS	BOLTS FOR SAFTY HINGE
G		6 PCS	SCREWS FOR BOTTOM PANEL
H		2 PCS	HINGE, ONE SIDE PRE-ATTACHED ON LID
I		1 PC	SAFETY HINGE, ONE SIDE PRE-ATTACHED ON TRUNK FRAME
J		1 PC	ALLEN WRENCH

MADE IN VIETNAM

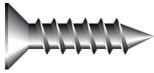
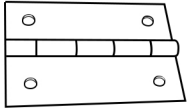
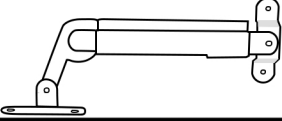
STEP 1

****TWO PERSONS ASSEMBLY IS REQUIRED FOR THE STEP**

1. Place Front & Back trunk frame (A;A1) per drawing shown.
2. Place Left and Right side trunk frame (B;B1) and align well to Front & Back trunk frames (A;A1)
3. Insert Bolts (E) and tighten with Allen wrench (J) loosely tighten.

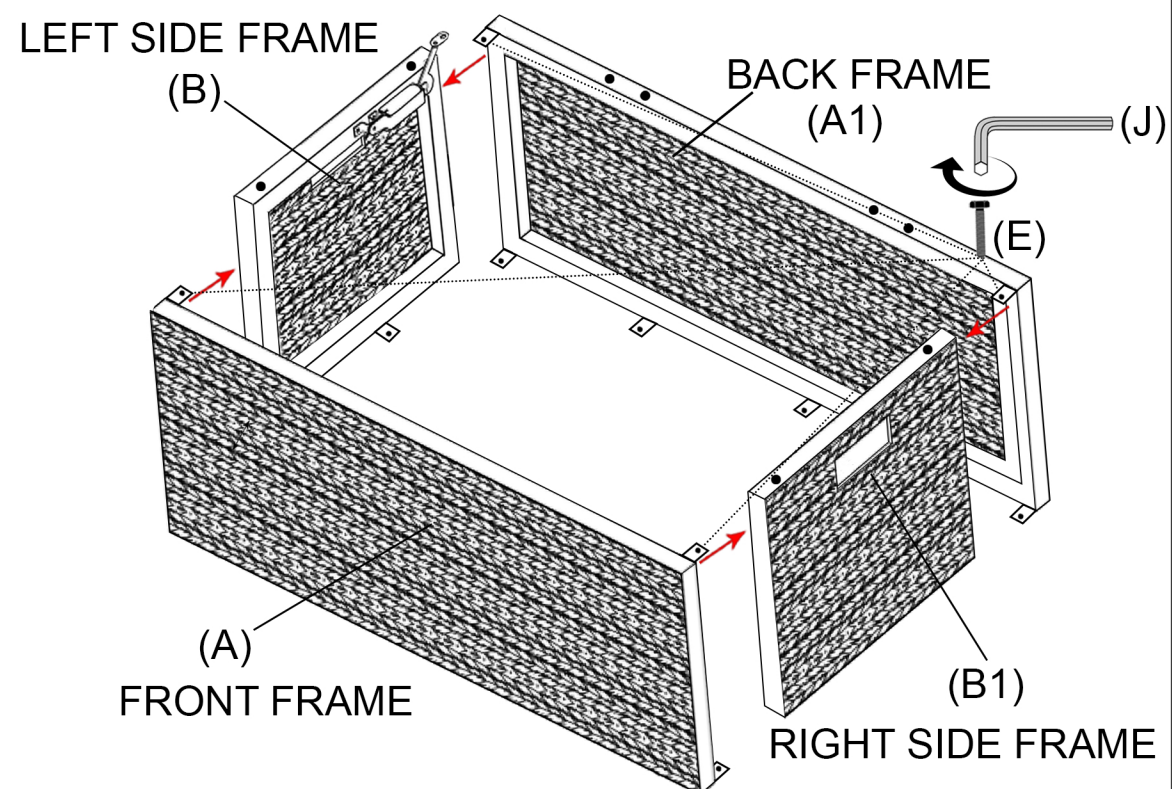

ASSEMBLY INSTRUCTIONS
WATER HYACINTH K/D TRUNK
PRODUCT#: CS5668 / CFV2696NAT
TWO PERSONS ASSEMBLY IS REQUIRED

STEP 2

- **TWO PERSONS ASSEMBLY IS REQUIRED FOR THE STEP**
1. Place the bottom panel (D) per drawing shown.
 2. Hold bottom panel (D) to the metal brackets. Insert screws (G). Loosely tighten with Phillips-Head screwdriver (Not provided).

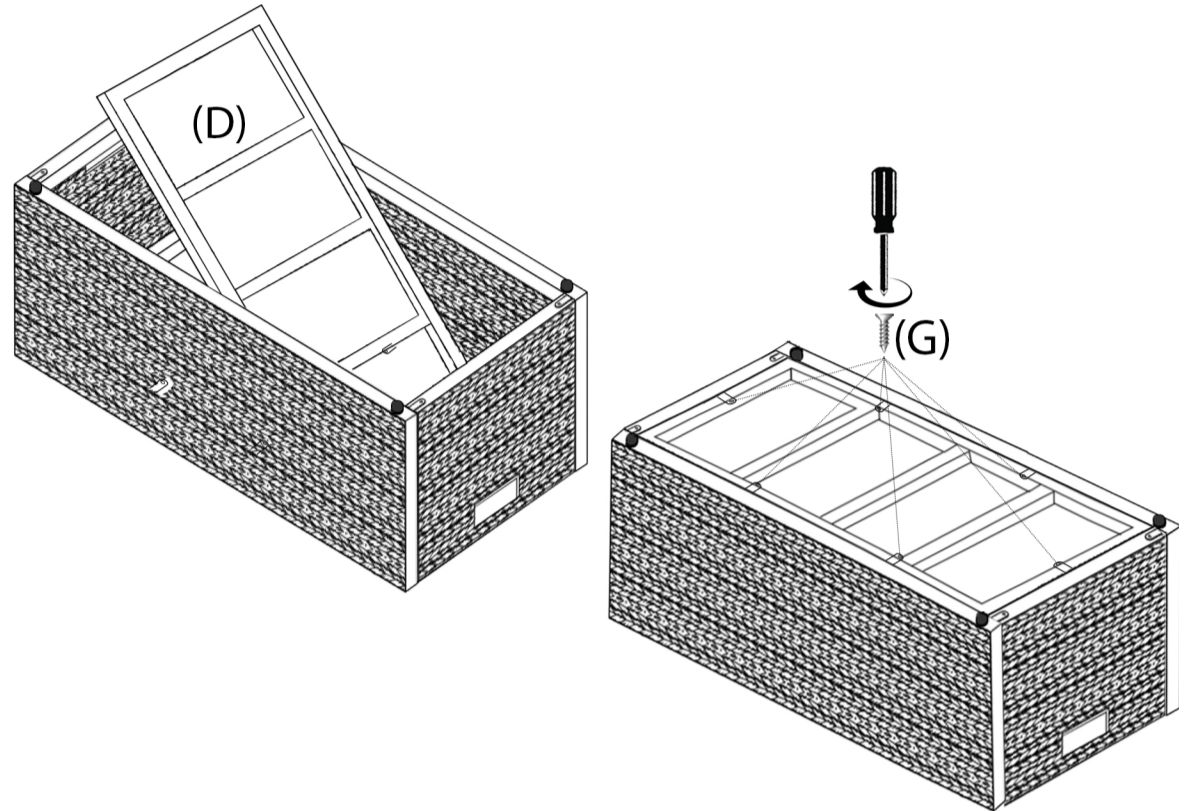

STEP 3

- **TWO PERSONS ASSEMBLY IS REQUIRED FOR THE STEP**
1. Upright the trunk assembled from step 2.
 2. Place Lid (C) per drawing shown and align hinges (H) to the pre-drilled holes. Insert bolts (E) then loosely tighten with allen wrench (J).

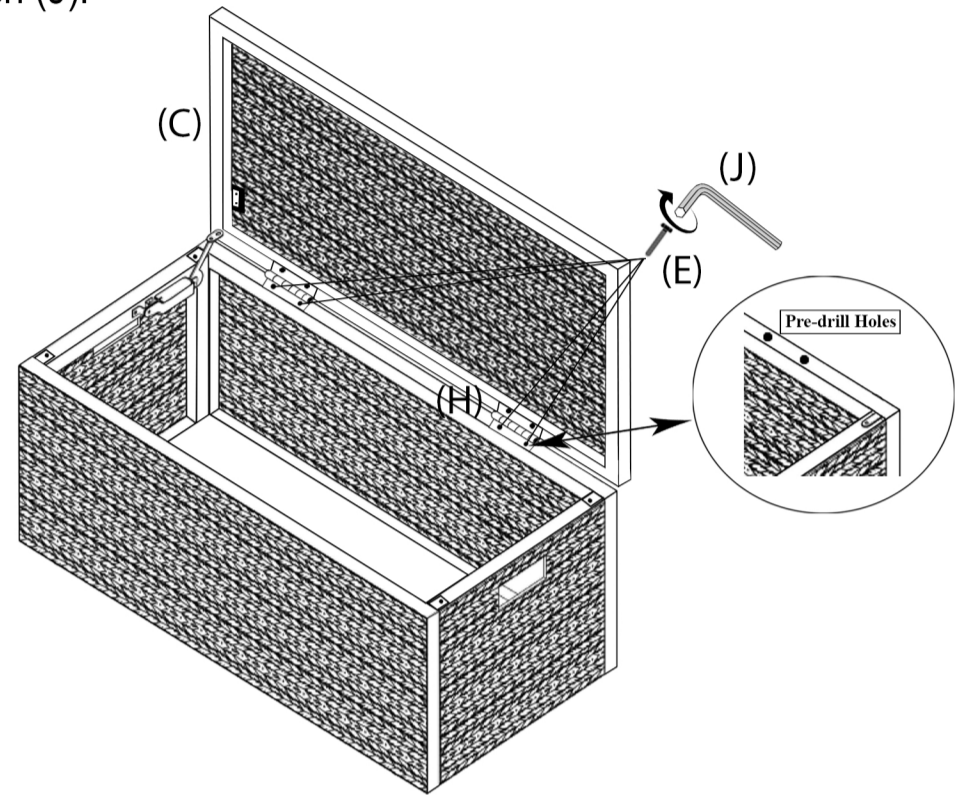

STEP 4

1. Attach safety hinge (I) to METAL BRACKET on Lid (C) with bolts (F). Loosely tighten with Phillips-Head screwdriver (Not provided).

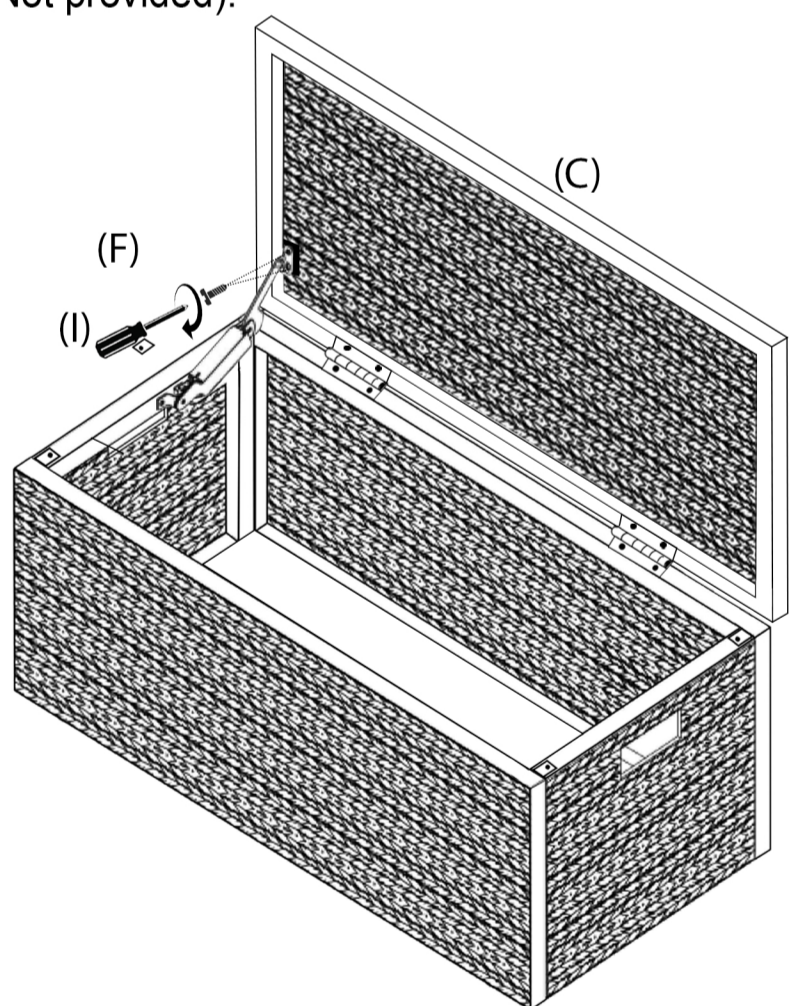

STEP 5

1. Fully tighten all bolts and screws.
2. Adjust floor gliders for leveling.
3. Trunk is ready for use.

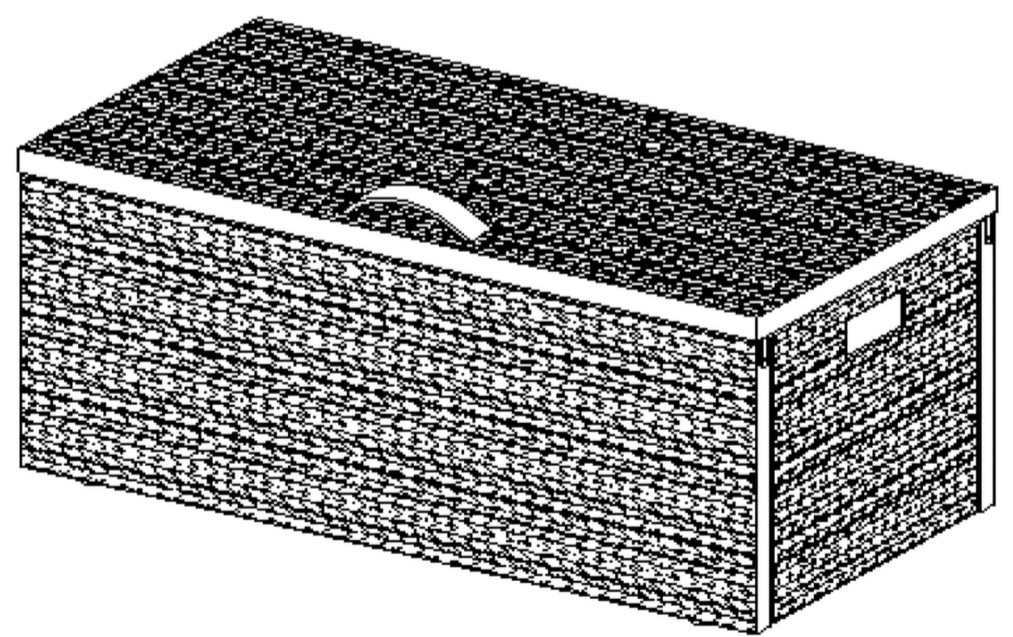

IMPORTANT NOTE:

- ***PLACE ALL PARTS ON A CLEAN AND SMOOTH SURFACE SUCH AS A RUG OR CARPET TO AVOID SCRATCHING THE PARTS.
 - ***KINDLY FOLLOW THE ASSEMBLY INSTRUCTION STEP BY STEP.
 - ***DO NOT STAND OR CLIMB ON THE TRUNK.
 - ***DO NOT RECOMMEND TO USE POWER TOOL OR GENTLY USE IT.
 - ***NO FOR COMMERCIAL USE
 - ***IN CASE YOU NEED ANY EXTRA PARTS, PLEASE CONTACT US DIRECTLY INSTEAD OF RETURNING YOUR ORDER
- PLEASE EMAIL Service@ehemco.com OR CALL (847) 2899955. WE WILL BE MORE THAN HAPPY TO HELP YOU WITHIN A BUSINESS DAY