

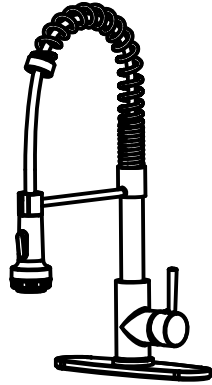

Note:Style may vary by model



Before Installation

- A . Make sure you have all necessary parts by checking the diagram and parts list.
- B . Turn off the hot and cold water supply at the angle stops and turn on the old faucet to release any built up pressure. Remove existing faucet. Clean sink or countertop in preparation for new faucet.
- C . Shut off angle stops.
- D .Pre-drilled size requirement:1-3/8" (min)-1-1/2" (max)  
 Max countertop thickness without deck plate:1-1/2" (1hole install)  
 Max countertop thickness with deck plate:1" (1, 2or 3 hole install)

1/16" (1mm) min		1/16" (1mm) min	
1-1/2" (38mm) max		1" (25.4mm) max	
Ø1-3/8" (35mm) min		Ø1-3/8" (35mm) min	
Ø1-1/2" (38mm) max		Ø1-1/2" (38mm) max	

Tools you will need:



Adjustable Wrench



Safety Goggles

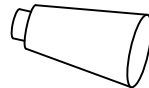

Silicone Sealant



Bucket

Diagram and Parts List

Note:Style may vary by model.

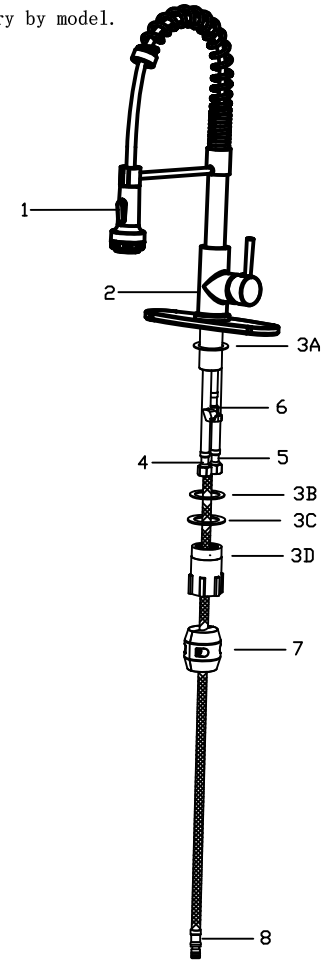

- 1. Sprayer Head
- 2. Faucet Body
- 3. Mounting Hardware
  - A. Black Washer
  - B. Clear Washer
  - C. Metal Washer
  - D. Mounting Nut
- 4. Hot&Cold Waterlines
- 5. Supply Hose
- 6. Quick Connect
- 7. Weight
- 8. Sprayer Hose

Note:Style may vary by model

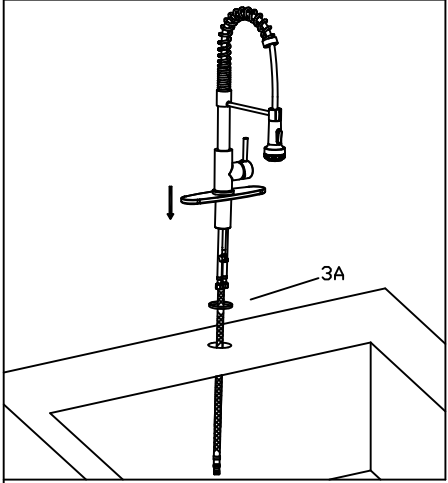
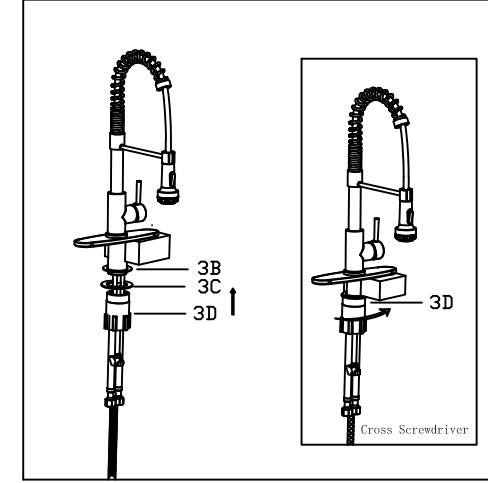
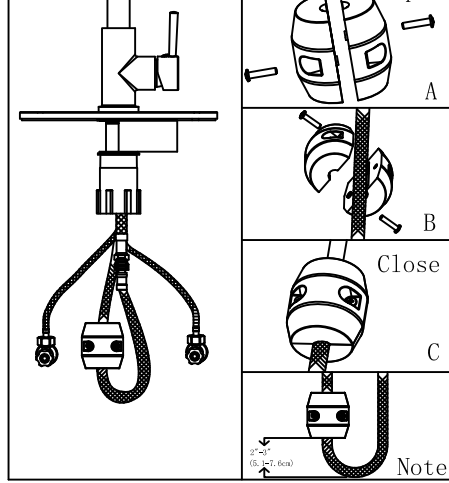
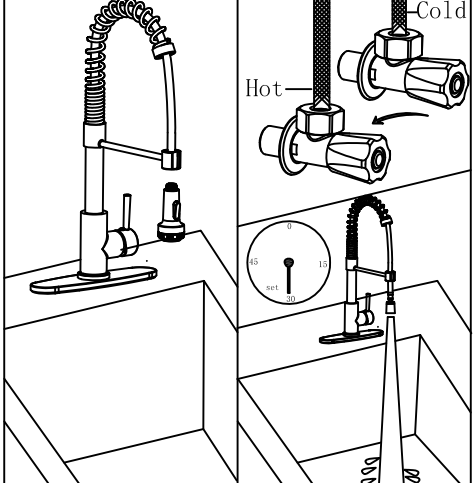
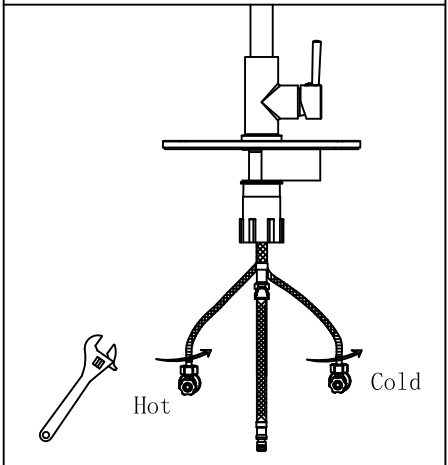
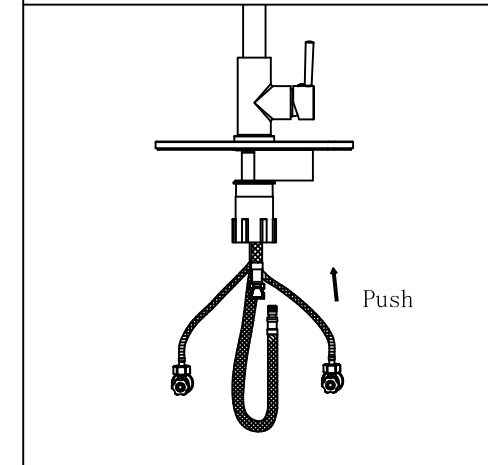
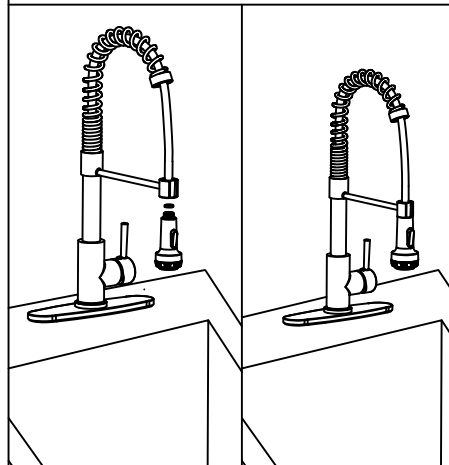
<p>1 Slide the washer (O-ring) to faucet base. Insert the new faucet through sink.</p> 	<p>2 Put the washer on screw nut. Screw the nut onto thread. Before tighten, rotate the hand to the side you like, then tighten the nut securely.</p> 	<p>5 Open the weight, put it on sprayer hose. Then close it. Note: To make sure that the pull out hose go back smoothly, you need to adjust the weight in right position.</p> 	<p>6 Place handle in off position. Screw off the sprayer head. Note: Don't lost the o-ring</p> <p>7 Turn on water supply. Check for leaks and flush hoses and flush the faucet for 30s.</p> 
<p>3 Correct and tighten hot and cold water hose. Note: Made sure that a small washer (o-ring) is put on each water-line before screwing.</p> 	<p>4 Push the sprayer hose to the quick connect. Note: please do not use the tape for the quick connect.</p> 	<p>8 Turn off the faucet, screw the sprayer head back the the sprayer hose. Note: Don't forget the o-gring.</p> 	<p>Care and Clean</p> <p>For best results, keep the following in mind when caring for your faucet:</p> <p>Use a mild detergent such as liquid dish washing soap and warm water for cleaning. Do not use abra-sive cleaners that may scratch or dull the surface.</p> <p>Carefully read the cleaner product label to ensure the cleaner is safe for use on the entire surface.</p> <p>Always test your cleaning solution on an inconspicuous area before applying to the entire surface.</p> <p>Do not allow cleanere to sit or soak on the surface,</p> <p>Wipe surface clean and rinse completely with water immediately after cleaning application. Rinse and dry any overpray that lands on nearby surface.</p>